



Newland AIDC
Scanning Made Simple



Fixed-mount Barcode Scanner

NLS-FM3280

**User
Guide**

Disclaimer

© 2023 Fujian Newland Auto-ID Tech. Co., Ltd. All rights reserved.

Please read through the manual carefully before using the product and operate it according to the manual. It is advised that you should keep this manual for future reference.

Do not disassemble the device or remove the seal label from the device, doing so will void the product warranty provided by Fujian Newland Auto-ID Tech. Co., Ltd.

All pictures in this manual are for reference only and actual product may differ. Regarding to the product modification and update, Fujian Newland Auto-ID Tech. Co., Ltd. reserves the right to make changes to any software or hardware to improve reliability, function, or design at any time without notice. The information contained herein is subject to change without prior notice.

The products depicted in this manual may include software copyrighted by Fujian Newland Auto-ID Tech. Co., Ltd or third party. The user, corporation or individual, shall not duplicate, in whole or in part, distribute, modify, decompile, disassemble, decode, reverse engineer, rent, transfer or sublicense such software without prior written consent from the copyright holders.

This manual is copyrighted. No part of this publication may be reproduced, distributed or used in any form without written permission from Newland.

Fujian Newland Auto-ID Tech. Co., Ltd. reserves the right to make final interpretation of the statement above.

Fujian Newland Auto-ID Tech. Co., Ltd.

3F, Building A, No.1, Rujiang West Rd., Mawei, Fuzhou, Fujian, China 350015

<http://www.newlandaidc.com>

Revision History

| Version | Description | Date |
|---------|---|-----------------|
| V1.0.0 | Initial release. | August 10, 2023 |
| V1.0.1 | Update the tolerances of the mechanical mounting dimensions in Figure 2-1 | August 18, 2025 |

Table of Contents

| | |
|--|-----------|
| Revision History | 3 |
| Preface | 1 |
| Introduction | 1 |
| Chapter Description | 1 |
| Explanation of Symbols | 2 |
| Explanation of Icons | 2 |
| Chapter 1 Getting Started | 3 |
| Introduction | 3 |
| Symbologies | 3 |
| Features | 3 |
| FM3280 Scanner | 4 |
| Chapter 2 Installation | 6 |
| Introduction | 6 |
| Dimensions (unit: mm) | 6 |
| Mounting | 7 |
| RJ50 Port | 8 |
| ESD | 8 |
| Dust and Dirt | 8 |
| Ambient Environment | 8 |
| Thermal Considerations | 9 |
| Maintenance | 10 |
| Chapter 3 Optics | 11 |
| Introduction | 11 |
| Sensor | 11 |
| Illumination | 11 |
| Normal Working Status Indicators | 11 |
| Abnormal Status Indicators | 12 |
| Window Size | 14 |
| Ambient Light | 16 |
| Eye Safety | 16 |
| Depth of Field | 16 |
| Chapter 4 Electrical Specifications | 17 |
| Power Supply | 17 |
| Ripple Noise | 17 |
| Interface Pinouts | 18 |
| DC Characteristics | 19 |

| | |
|--|-----------|
| Operating Voltage | 19 |
| Operating Current | 19 |
| I/O Voltage | 20 |
| Chapter 5 Auxiliary Tools..... | 21 |
| EasySet..... | 21 |
| UFCOM..... | 22 |
| Chapter 6 Configuration | 23 |
| Introduction | 23 |
| Barcode Programming | 23 |
| Command Programming..... | 23 |
| EasySet Programming | 23 |
| Programming Barcode/ Programming Command/Function..... | 24 |
| Use of Programming Barcodes | 25 |
| Default Settings..... | 26 |
| Factory Defaults..... | 26 |
| Custom Defaults | 26 |
| Query Product Information | 27 |
| Query Product Name | 27 |
| Query Firmware Version | 27 |
| Query Hardware Version..... | 28 |
| Query Product Serial Number | 28 |
| Query Manufacturing Date | 29 |
| Query OEM Serial Number | 29 |
| Query Data Formatter Version | 29 |
| Self-check Function..... | 30 |
| Enable Self-Check Function..... | 30 |
| Chapter 7 Communication Interface | 32 |
| Introduction | 32 |
| Adaptive Wired Communication | 33 |
| RS-232 Interface | 34 |
| Baud Rate | 35 |
| Parity Check..... | 36 |
| Data Bit | 37 |
| Stop Bit | 37 |
| Hardware Auto Flow Control | 38 |
| RS-485 Interface..... | 39 |
| Slave Mode..... | 39 |
| Set the Slave Address..... | 39 |
| Wiegand Interface | 41 |

| | |
|---|-----------|
| Wiegand Format | 41 |
| USB HID Keyboard | 42 |
| USB Country Keyboard Types | 43 |
| Beep on Unknown Character | 47 |
| Emulate ALT+Keypad | 48 |
| Code Page | 49 |
| Unicode Encoding | 51 |
| Emulate Keypad with Leading Zero | 51 |
| Function Key Mapping | 52 |
| ASCII Function Key Mapping Table..... | 53 |
| ASCII Function Key Mapping Table (Continued) | 54 |
| Inter-Keystroke Delay..... | 55 |
| Caps Lock | 56 |
| Convert Case | 57 |
| Emulate Numeric Keypad | 58 |
| Fast Mode | 60 |
| Polling Rate..... | 61 |
| USB CDC | 63 |
| HID POS (POS HID Barcode Scanner)..... | 64 |
| Introduction | 64 |
| Access the Scanner with Your Program | 64 |
| Acquire Scanned Data | 65 |
| Send Command to the Scanner | 65 |
| IBM SurePOS (Tabletop)..... | 66 |
| IBM SurePOS (Handheld)..... | 66 |
| Datalogic Magellan Aux-RS232..... | 67 |
| VID/PID | 69 |
| Chapter 8 System Settings | 70 |
| Scan Mode | 70 |
| Decode Session Timeout | 71 |
| Types of Triggering..... | 72 |
| Debounce Time | 72 |
| Enter the Detection/ Reading State (Sense Mode) | 73 |
| Image Stabilization Timeout (Sense Mode)..... | 74 |
| Trigger Selection (Sense Mode)..... | 75 |
| Image Change Trigger Sensitivity | 76 |
| IR Proximity Trigger Sensitivity | 77 |
| Illumination During the Detection State | 78 |
| Reread Timeout..... | 78 |
| Good Read Delay..... | 81 |

| | |
|--|-----|
| Scanning Preference..... | 82 |
| Scanning After Power-on | 83 |
| Decode Area | 83 |
| Image Flipping..... | 86 |
| Bad Read Message..... | 87 |
| Set Bad Read Message | 88 |
| Good Read Signal..... | 89 |
| Polarity of Good Read Signal..... | 89 |
| Good Read Indicator Duration | 90 |
| Trigger Commands..... | 91 |
| Modify Start Scanning Command | 91 |
| Modify Stop Scanning Command..... | 92 |
| Illumination | 93 |
| Illumination Brightness..... | 93 |
| Illumination Color Selection..... | 94 |
| Good Read LED..... | 94 |
| Good Read LED Duration | 95 |
| Access Control Mode | 96 |
| Power On Beep..... | 98 |
| Good Read Beep | 98 |
| Good Read Beep Duration..... | 99 |
| Good Read Beep Frequency | 100 |
| Good Read Beep Volume | 101 |
| NFC Function..... | 102 |
| NFC Card Searching Duration | 102 |
| NFC Mode..... | 103 |
| NFC Card Type Available for the FM3280..... | 104 |
| Timeout between Decodes (Same NFC Card)..... | 105 |

Chapter 9 Symbologies..... 108

| | |
|---|-----|
| Introduction | 108 |
| Global Settings..... | 108 |
| Enable/Disable All Symbologies..... | 108 |
| Enable/Disable 1D Symbologies..... | 108 |
| Enable/Disable 2D Symbologies..... | 109 |
| Enable/Disable Postal Symbologies | 109 |
| 1D Twin Code | 110 |
| Surround GS1 Application Identifiers (AI's) with Parentheses..... | 111 |
| Security Level..... | 112 |
| Enable Security Level | 112 |
| Disable Security Level..... | 115 |

| | |
|--|-----|
| Code 128..... | 119 |
| Restore Factory Defaults | 119 |
| Enable/Disable Code 128 | 119 |
| Set Length Range for Code 128 | 120 |
| EAN-8 | 121 |
| Restore Factory Defaults | 121 |
| Enable/Disable EAN-8 | 121 |
| Transmit Check Character | 121 |
| 2-Digit Add-On Code | 122 |
| 5-Digit Add-On Code | 123 |
| Add-On Code Required..... | 124 |
| Convert EAN-8 to EAN-13 | 124 |
| EAN-13 | 125 |
| Restore Factory Defaults | 125 |
| Enable/Disable EAN-13 | 125 |
| Transmit Check Character | 126 |
| 2-Digit Add-On Code | 126 |
| 5-Digit Add-On Code | 127 |
| Add-On Code Required..... | 127 |
| EAN-13 Beginning with 290 Add-On Code Required | 128 |
| EAN-13 Beginning with 378/379 Add-On Code Required | 128 |
| EAN-13 Beginning with 414/419 Add-On Code Required | 129 |
| EAN-13 Beginning with 434/439 Add-On Code Required | 129 |
| EAN-13 Beginning with 977 Add-On Code Required | 130 |
| EAN-13 Beginning with 978 Add-On Code Required | 130 |
| EAN-13 Beginning with 979 Add-On Code Required | 131 |
| JAN Code for Magazines | 132 |
| UPC-E..... | 133 |
| Restore Factory Defaults | 133 |
| Enable/Disable UPC-E..... | 133 |
| Transmit Check Character | 134 |
| 2-Digit Add-On Code | 134 |
| 5-Digit Add-On Code | 135 |
| Add-On Code Required..... | 135 |
| Transmit Preamble Character | 136 |
| Extend UPC-E as UPC-A..... | 136 |
| UPC-A..... | 137 |
| Restore Factory Defaults | 137 |
| Enable/Disable UPC-A..... | 137 |
| Transmit Check Character | 137 |

| | |
|--|-----|
| 2-Digit Add-On Code | 138 |
| 5-Digit Add-On Code | 139 |
| Add-On Code Required..... | 140 |
| Transmit Preamble Character | 140 |
| Coupon | 141 |
| UPC-A/EAN-13 with Extended Coupon Code..... | 141 |
| Coupon GS1 Databar Output..... | 142 |
| Interleaved 2 of 5 | 143 |
| Restore Factory Defaults | 143 |
| Enable/Disable Interleaved 2 of 5 | 143 |
| Set Length Range for Interleaved 2 of 5 | 144 |
| Check Character Verification..... | 145 |
| Febraban..... | 146 |
| Disable/Enable Febraban..... | 146 |
| Transmit Delay per Character | 146 |
| Transmit Delay per 12 Characters | 149 |
| ITF-14 | 151 |
| Restore Factory Defaults | 151 |
| Enable/Disable ITF-14 | 151 |
| ITF-6 | 152 |
| Restore Factory Defaults | 152 |
| Enable/Disable ITF-6 | 152 |
| Matrix 2 of 5 | 153 |
| Restore Factory Defaults | 153 |
| Enable/Disable Matrix 2 of 5 | 153 |
| Set Length Range for Matrix 2 of 5 | 154 |
| Check Character Verification..... | 155 |
| Code 39 | 156 |
| Restore Factory Defaults | 156 |
| Enable/Disable Code 39 | 156 |
| Set Length Range for Code 39 | 157 |
| Check Character Verification..... | 158 |
| Transmit Start/Stop Character..... | 159 |
| Enable/Disable Code 39 Full ASCII | 159 |
| Enable/Disable Code 32 (Italian Pharma Code) | 160 |
| Code 32 Prefix | 160 |
| Transmit Code 32 Start/Stop Character | 161 |
| Transmit Code 32 Check Character | 161 |
| Codabar | 162 |
| Restore Factory Defaults | 162 |

| | |
|--|-----|
| Enable/Disable Codabar | 162 |
| Set Length Range for Codabar | 163 |
| Check Character Verification..... | 164 |
| Start/Stop Character | 165 |
| Code 93 | 166 |
| Restore Factory Defaults | 166 |
| Enable/Disable Code 93 | 166 |
| Set Length Range for Code 93 | 167 |
| China Post 25..... | 168 |
| Restore Factory Defaults | 168 |
| Enable/Disable China Post 25 | 168 |
| Set Length Range for China Post 25 | 169 |
| Check Character Verification..... | 170 |
| GS1-128 (UCC/EAN-128)..... | 171 |
| Restore Factory Defaults | 171 |
| Enable/Disable GS1-128..... | 171 |
| Set Length Range for GS1-128..... | 172 |
| GS1 Databar (RSS) | 173 |
| Restore Factory Defaults | 173 |
| Enable/Disable GS1 Databar | 173 |
| Transmit Application Identifier "01" | 173 |
| GS1 Composite (EAN·UCC Composite)..... | 174 |
| Restore Factory Defaults | 174 |
| Enable/Disable GS1 Composite..... | 174 |
| Enable/Disable UPC/EAN Composite | 175 |
| Code 11..... | 176 |
| Restore Factory Defaults | 176 |
| Enable/Disable Code 11..... | 176 |
| Set Length Range for Code 11..... | 177 |
| Check Character Verification..... | 178 |
| Transmit Check Character | 179 |
| ISBN..... | 180 |
| Restore Factory Defaults | 180 |
| Enable/Disable ISBN..... | 180 |
| Set ISBN Format..... | 181 |
| ISSN..... | 181 |
| Restore Factory Defaults | 181 |
| Enable/Disable ISSN..... | 182 |
| Industrial 25..... | 183 |
| Restore Factory Defaults | 183 |

| | |
|--|-----|
| Enable/Disable Industrial 25 | 183 |
| Set Length Range for Industrial 25 | 184 |
| Check Character Verification..... | 185 |
| Standard 25..... | 186 |
| Restore Factory Defaults | 186 |
| Enable/Disable Standard 25 | 186 |
| Set Length Range for Standard 25 | 187 |
| Check Character Verification..... | 188 |
| Plessey | 189 |
| Restore Factory Defaults | 189 |
| Enable/Disable Plessey | 189 |
| Set Length Range for Plessey | 190 |
| Check Character Verification..... | 191 |
| MSI-Plessey | 192 |
| Restore Factory Defaults | 192 |
| Enable/Disable MSI-Plessey..... | 192 |
| Set Length Range for MSI-Plessey..... | 193 |
| Check Character Verification..... | 194 |
| Transmit Check Character | 195 |
| AIM 128..... | 196 |
| Restore Factory Defaults | 196 |
| Enable/Disable AIM 128..... | 196 |
| Set Length Range for AIM 128..... | 197 |
| ISBT 128 | 198 |
| Restore Factory Defaults | 198 |
| Enable/Disable ISBT 128 | 198 |
| Code 49 | 199 |
| Restore Factory Defaults | 199 |
| Enable/Disable Code 49 | 199 |
| Set Length Range for Code 49 | 200 |
| Code 16K | 201 |
| Restore Factory Defaults | 201 |
| Enable/Disable Code 16K..... | 201 |
| Set Length Range for Code 16K..... | 202 |
| PDF417 | 203 |
| Restore Factory Defaults | 203 |
| Enable/Disable PDF417..... | 203 |
| Set Length Range for PDF417..... | 204 |
| PDF417 Twin Code..... | 205 |
| PDF417 Inverse | 206 |

| | |
|--|-----|
| Character Encoding | 206 |
| PDF417 ECI Output | 207 |
| Micro PDF417 | 208 |
| Restore Factory Defaults | 208 |
| Enable/Disable Micro PDF417 | 208 |
| Set Length Range for Micro PDF417 | 209 |
| QR Code | 210 |
| Restore Factory Defaults | 210 |
| Enable/Disable QR Code | 210 |
| Set Length Range for QR Code | 211 |
| QR Twin Code | 212 |
| QR Inverse | 213 |
| Character Encoding | 213 |
| QR ECI Output | 215 |
| URL QR | 215 |
| Micro QR Code | 216 |
| Restore Factory Defaults | 216 |
| Enable/Disable Micro QR | 216 |
| Set Length Range for Micro QR | 217 |
| Aztec | 218 |
| Restore Factory Defaults | 218 |
| Enable/Disable Aztec Code | 218 |
| Set Length Range for Aztec Code | 219 |
| Read Multi-barcodes on an Image | 220 |
| Set the Number of Barcodes | 221 |
| Character Encoding | 222 |
| Aztec ECI Output | 222 |
| Data Matrix | 223 |
| Restore Factory Defaults | 223 |
| Enable/Disable Data Matrix | 223 |
| Set Length Range for Data Matrix | 224 |
| Data Matrix Twin Code | 225 |
| Rectangular Barcode | 226 |
| Data Matrix Inverse | 226 |
| Character Encoding | 227 |
| Data Matrix ECI Output | 227 |
| Chinese Sensible Code | 228 |
| Restore Factory Defaults | 228 |
| Enable/Disable Chinese Sensible Code | 228 |
| Set Length Range for Chinese Sensible Code | 229 |

| | |
|--|-----|
| Chinese Sensible Twin Code | 230 |
| Chinese Sensible Code Inverse | 231 |
| GM Code | 232 |
| Restore Factory Defaults | 232 |
| Enable/Disable GM | 232 |
| Set Length Range for GM | 233 |
| Code One | 234 |
| Restore Factory Defaults | 234 |
| Enable/Disable Code One | 234 |
| Set Length Range for Code One | 235 |
| USPS Postnet | 236 |
| Restore Factory Defaults | 236 |
| Enable/Disable USPS Postnet | 236 |
| Transmit Check Character | 236 |
| USPS Intelligent Mail | 237 |
| Restore Factory Defaults | 237 |
| Enable/Disable USPS Intelligent Mail | 237 |
| Royal Mail | 238 |
| Restore Factory Defaults | 238 |
| Enable/Disable Royal Mail | 238 |
| USPS Planet | 239 |
| Restore Factory Defaults | 239 |
| Enable/Disable USPS Planet | 239 |
| Transmit Check Character | 239 |
| KIX Post | 240 |
| Restore Factory Defaults | 240 |
| Enable/Disable KIX Post | 240 |
| Australian Postal | 241 |
| Restore Factory Defaults | 241 |
| Enable/Disable Australian Postal | 241 |
| Japan Post | 242 |
| Restore Factory Defaults | 242 |
| Enable/Disable Japan Post | 242 |
| Chinese ID Card OCR | 243 |
| Restore Factory Defaults | 243 |
| Enable/Disable Chinese ID Card OCR | 243 |
| Passport OCR | 244 |
| Restore Factory Defaults | 244 |
| Enable/Disable Passport OCR | 244 |
| China Travel Permit OCR | 245 |

| | |
|--|------------|
| Restore Factory Defaults | 245 |
| Enable/Disable China Travel Permit OCR..... | 245 |
| Chapter 10 Data Formatter | 246 |
| Introduction | 246 |
| Add a Data Format..... | 246 |
| Programming with Barcodes | 246 |
| Programming with Serial Commands..... | 249 |
| Enable/Disable Data Formatter | 250 |
| Non-Match Error Beep | 251 |
| Data Format Selection | 252 |
| Change Data Format for a Single Scan | 253 |
| Clear Data Format..... | 254 |
| Query Data Formats..... | 254 |
| Formatter Command Type 6 | 255 |
| Send Commands | 255 |
| Move Commands..... | 258 |
| Search Commands | 260 |
| Miscellaneous Commands | 263 |
| Chapter 11 Prefix & Suffix..... | 269 |
| Introduction | 269 |
| Global Settings..... | 270 |
| Enable/Disable All Prefixes/Suffixes..... | 270 |
| Prefix Sequence..... | 270 |
| Custom Prefix..... | 271 |
| Enable/Disable Custom Prefix | 271 |
| Set Custom Prefix | 271 |
| AIM ID Prefix..... | 272 |
| Code ID Prefix..... | 273 |
| Restore All Default Code IDs | 273 |
| Modify Code ID | 274 |
| Custom Suffix..... | 283 |
| Enable/Disable Custom Suffix..... | 283 |
| Set Custom Suffix | 283 |
| Data Packing..... | 284 |
| Introduction | 284 |
| Data Packing Options | 284 |
| Terminating Character Suffix | 286 |
| Enable/Disable Terminating Character Suffix..... | 286 |
| Set Terminating Character Suffix..... | 286 |

| | |
|--|------------|
| Chapter 12 Programming Commands | 288 |
| Use of Programming Command | 288 |
| Query Commands | 288 |
| Command Syntax | 288 |
| Responses | 289 |
| Examples | 289 |
| Read Barcode On/Off | 290 |
| Make a Beeping Sound | 290 |
| Turn On Good Read LED | 291 |
| Turn On Illumination LED | 291 |
| Chapter 13 Batch Programming | 292 |
| Introduction | 292 |
| Create a Batch Command | 293 |
| Create a Batch Barcode | 293 |
| Use Batch Barcode | 294 |
| Appendix | 295 |
| Digit Barcodes | 295 |
| Save/Cancel Barcodes | 298 |
| Factory Defaults Table (ST.H01.U2.2) | 299 |
| AIM ID Table(V2022.6) | 309 |
| Code ID Table(V1.00.0) | 311 |
| Symbology ID Number(V1.00.0) | 313 |
| ASCII Table | 315 |
| Keyboard Key References | 319 |

Preface

Introduction

This manual provides installation, optics, electrical specifications as well as detailed instructions for setting up and using the NLS-FM3280 scanner (hereinafter referred to as “the FM3280” or “the scanner”).

This guide provides programming instructions for the FM3280. Users can configure the FM3280 by scanning the programming barcodes included in this manual.

The FM3280 has been properly configured for most applications and can be put into use without further configuration. Users may check Appendix: Factory Defaults Table for reference.

Chapter Description





- ✧ *Chapter 1, Getting Started* : Gives a general description of the FM3280.
- ✧ *Chapter 2, Installation* : Describes how to install the scanner, including installation information, connector, cable, ESD, and environmental considerations.
- ✧ *Chapter 3, Optics* : Provides parameters for optics and illumination.
- ✧ *Chapter 4 Electrical Specifications* : Includes the electrical characteristics for the scanner and timing sequences.
- ✧ *Chapter 5, Auxiliary Tools* : Introduces useful tools you can use to set up the FM3280.
- ✧ *Chapter 6 Configuration* : Introduces the use of programming barcodes and product information query.
- ✧ *Chapter 7 Communication Interface* : Describes how to configure RS-232 and USB communication parameters.
- ✧ *Chapter 8, System Settings* : Describes how to configure general parameters of the FM3280.
- ✧ *Chapter 9, Symbologies* : Lists all compatible symbologies and describes how to configure the relevant parameters.
- ✧ *Chapter 10, Data Formatter* : Explains how to customize scanned data with the advanced data formatter.
- ✧ *Chapter 11, Prefix & Suffix* : Describes how to use prefix and suffix to customize scanned data.
- ✧ *Chapter 12 Programming Commands* : Introduces how to configure the FM3280 by serial commands sent from the host.

-
- ◇ *Chapter 13, Batch Programming* : Explains how to integrate a complex programming task into a single barcode.
 - ◇ *Appendix* : Provides factory defaults table and a bunch of frequently used programming barcodes.

Explanation of Symbols

- This symbol indicates lists of required steps.
- ※ This symbol indicates notes of some parameters.

Explanation of Icons

| | |
|---|--|
|  | This icon indicates auxiliary tools that help users to refer to the manual at ease. |
|  | This icon indicates this information requires extra attention from the reader. |
|  | This icon indicates handy tips that can help you use or configure the scanner with ease. |
|  | This icon indicates practical examples that can help you to acquaint yourself with operations. |

Chapter 1 Getting Started

Introduction

The FM3280 fixed-mount barcode scanners are armed with CMOS image capturer and the Newland patented **UIMG**[®], a computerized image recognition system-on-chip, featuring fast scanning and accurate decoding on barcodes on virtually any medium - paper, magnetic card, mobile phones and LCD displays.



Note: This guide provides general instructions for the installation. Fujian Newland Auto-ID Tech. Co., Ltd. recommends an opto-mechanical engineer should conduct an opto-mechanical analysis before design.

Symbologies

The FM3280 can easily read printed barcodes and on-screen barcodes, including:

| | |
|--------|---|
| 1D | EAN-13, EAN-8, ISBN, ISSN, UPC-A, UPC-E, Code 128, GS1-128, AIM 128, ISBT 128, Codabar, Code 39, Code 93, Standard 25, Interleaved 2 of 5, Matrix 25, Industrial 25, ITF-14, ITF-6, Coupon, GS1 Composite, GS1 Databar, Code 11, China Post 25, Plessey, MSI Plessey, Code 49, Code 16K |
| 2D | PDF417, Micro PDF417, QR, Micro QR, Data Matrix, Aztec, Chinese Sensible Code, GM, Code One, |
| Postal | USPS Postnet, USPS Intelligent Mail, Royal Mail, USPS Planet, KIX Post, Australian Postal, Japan Post |
| OCR | Passport OCR, Chinese ID Card, China Travel Permit OCR |

Features

- Multi-color LED indicators for real-time feedback of device status.
- Support read and write functions for NFC card.
- Support device self-check function.

FM3280 Scanner

Non-NFC Version

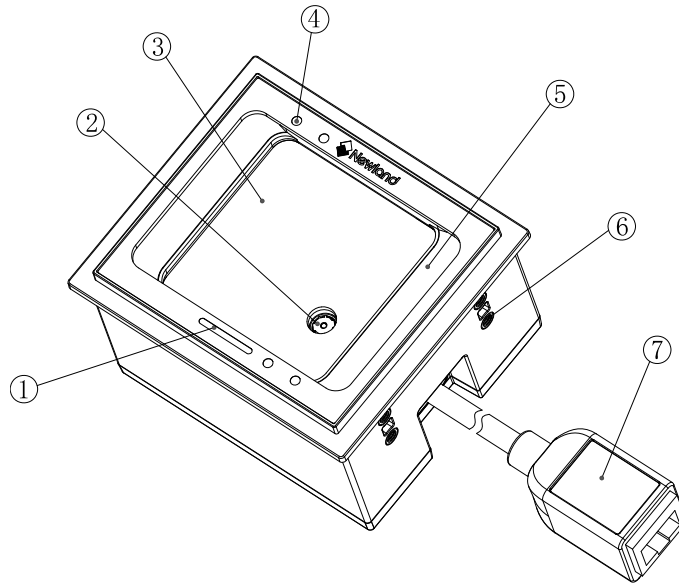

1. Status Indicator
2. Lens
3. Scan Window
4. IR LED
5. Illumination System
6. Mounting Hole
7. External Interface

Figure 1-1

NFC Version

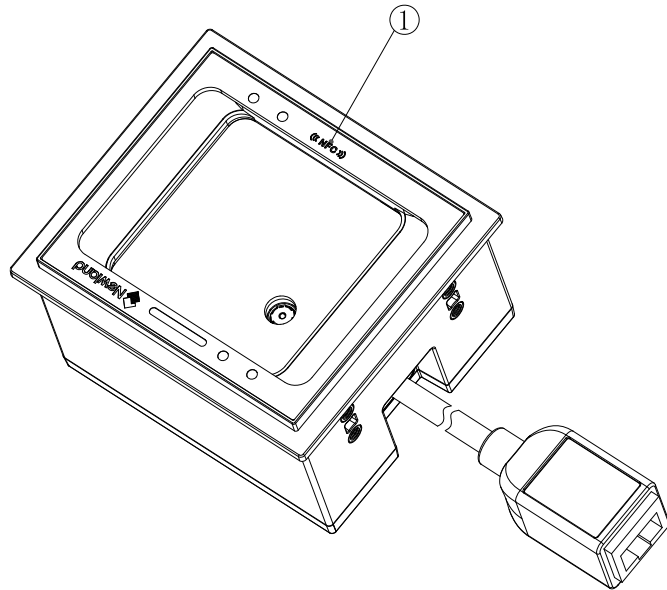

1. NFC LED

Figure 1-2

Chapter 2 Installation

Introduction

This chapter explains how to install the FM3280, including general requirements, housing design, and physical and optical information.



Caution: Do not touch the imaging lens when installing the scanner. Be careful not to leave fingerprints on the lens.



Caution: Do not touch the illumination LED during handling. Improper handling may damage the LED.



Caution: Ensure there is no metal or magnetic substances within 5cm of the device equipped with NFC, otherwise it will affect the reading performance.

Please contact the manufacturer or distributor to install the product.

Dimensions (unit: mm)

78.7(W)×47.7(D)×67.7(H) (max.) (without cable)

Mounting

The illustrations below show the mechanical mounting dimensions (unit: mm) for the FM3280.

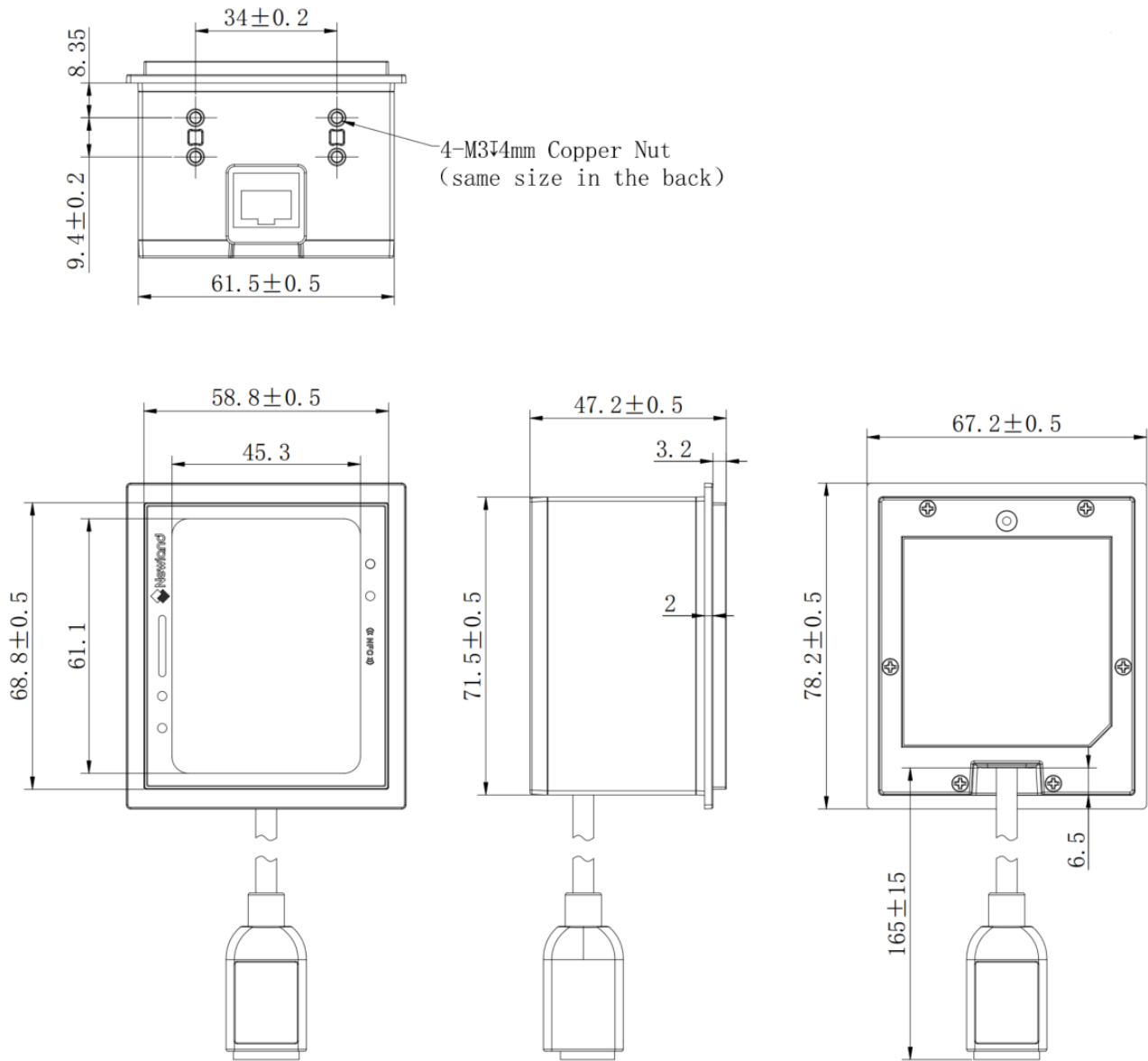

Figure 2-1

RJ50 Port

The FM3280 can be connected to the host via the RJ50 port.

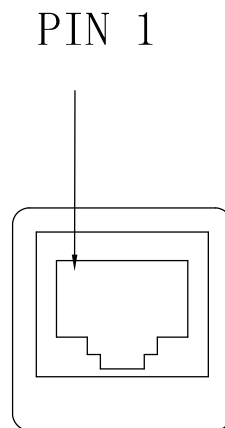

Figure 2-2

ESD

ESD protection has been taken into account when designing the FM3280. The scanner is shipped in ESD safe packaging. Always exercise care when handling the scanner outside its package. Be sure grounding wrist straps and properly grounded work areas are used.

Dust and Dirt

The FM3280 must be sufficiently enclosed to prevent dust particles from gathering on the lens and circuit board. Dust and other external contaminants will eventually degrade the scanner's performance.

Ambient Environment

The following environmental requirements should be met to ensure good performance of the FM3280.

Table 2-1

| | |
|-----------------------|-------------------------|
| Operating Temperature | -20°C to 60°C |
| Storage Temperature | -40°C to 85°C |
| Humidity | 5%~95% (non-condensing) |

Thermal Considerations

Electronic components in the FM3280 will generate heat during the course of their operation. Operating the FM3280 in continuous mode for an extended period may cause temperatures to rise on CPU, CIS, LEDs, DC-DC, etc. Overheating can degrade image quality and affect scanning performance. Given that, the following precautions should be taken into consideration when integrating the FM3280.

- ◇ Reserve sufficient space for good air circulation in the design.
- ◇ Avoid wrapping the FM3280 with thermal insulation materials.

Maintenance

- ✧ Keep the RJ50 port away from water.
- ✧ The scan window should be kept clean.
- ✧ Do not scratch the scan window.
- ✧ Use the soft cloth to clean the window, such as eyeglass cleaning cloth.
- ✧ Do not spray any liquid on the scan window.
- ✧ Do not use any detergent to clean other parts of the device except for water.

Note: The warranty DOES NOT cover damages caused by inappropriate care and maintenance.

Chapter 3 Optics

Introduction

The FM3280 contains:

- a CMOS image sensor and its lens
- eight white LEDs based illumination system and two diffusers
- two tri-color LEDs
- twoIR receiver LEDs and two IR transmitter LEDs

Sensor

Pixel: 1280×1088 CMOS

Frame rate: 60fps

Illumination

The FM3280 has two white LEDs for supplementary lighting, making it possible to scan barcodes even in complete darkness. The illumination can be programmed On or Off. There are two levels for illumination brightness, level 1 and level 2. When it is set as level 1, maximum scanning distance is shorter. Customers can add the external illumination system if needed. The spectral range should be within the visible light.

Normal Working Status Indicators

- Blue LED of logo on: upgrade or configuration process.
- Green LED of logo on: it indicates a good read.
- Blue LED of NFC on: NFC is working.
- Cyan LED of NFC on: an NFC-equipped card is read.

Abnormal Status Indicators

| | Status | Color of LED |
|------------------------|-----------------------------------|------------------|
| Decoding | All symbologies are disabled. | Purple |
| | Read Barcode Off is activated. | |
| | Unauthorized | Red |
| Abnormal Communication | USB communication is abnormal. | Red |
| | Serial communication is abnormal. | |
| | Device communication is abnormal. | |
| Configuration | Failed to upgrade. | Purple |
| | Configuration error. | |
| Peripheral | The sensor is not found. | Red |
| | CPU voltage is abnormal. | Red |
| | NFC module is abnormal. | Red (LED of NFC) |
| | Other chip is abnormal. | Red |

Non-NFC Version

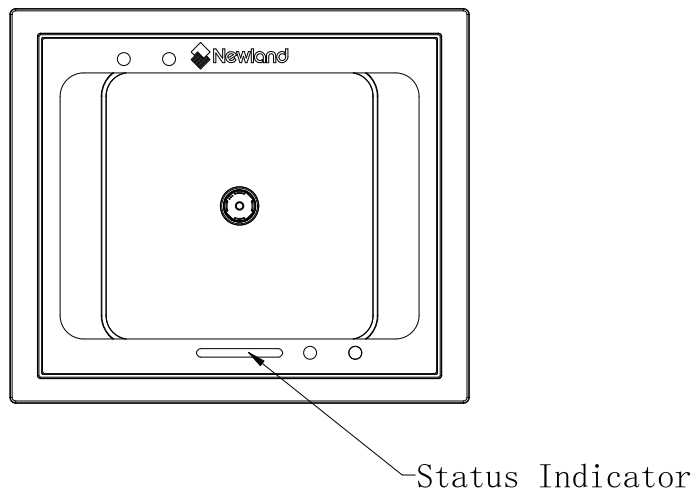

Figure 3-1

NFC Version

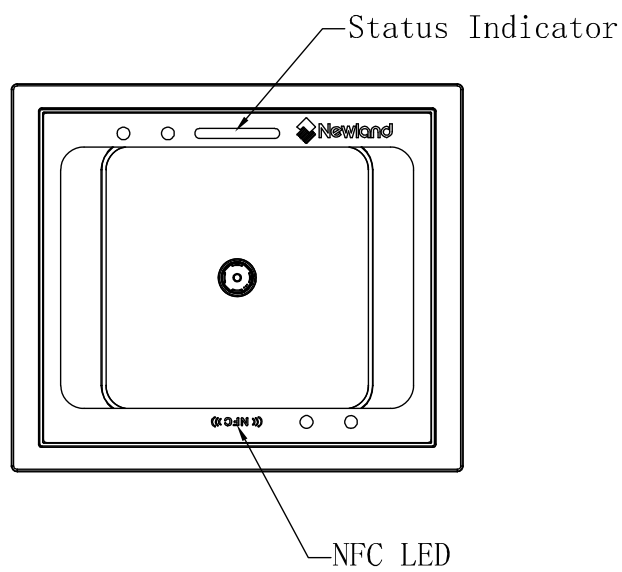

Figure 3-2

Window Size

The window must not block the field of view and should be sized to accommodate the illumination envelopes shown below.

Front View:

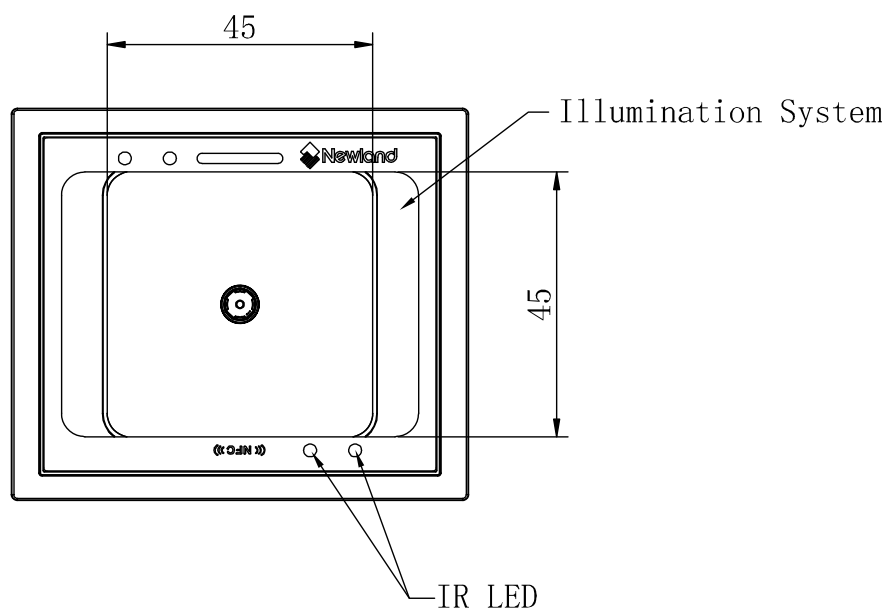

Figure 3-3

Horizontal:

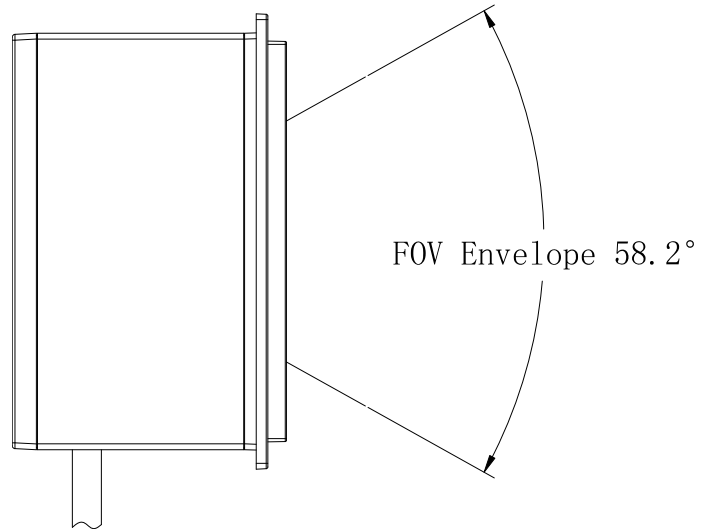

Figure 3-4

Vertical:

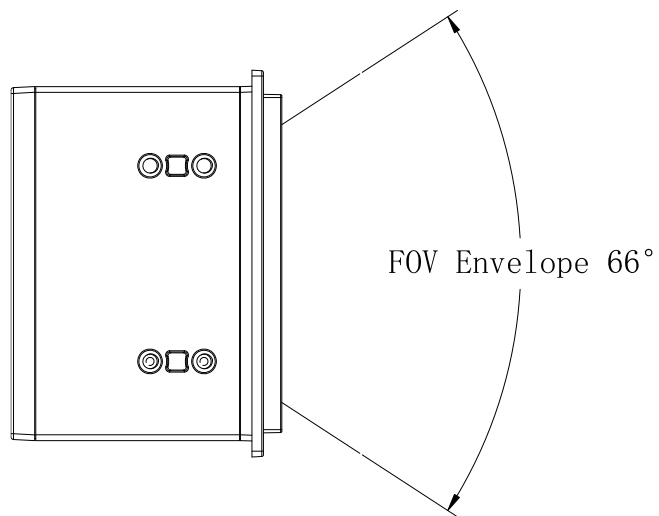

Figure 3-5

Ambient Light

The FM3280 shows better performance with ambient light. However, high-frequency pulsed light can result in performance degradation.

Eye Safety

The FM3280 uses LEDs to produce illumination beam. The LEDs are bright, but testing has been done to demonstrate that the scanner is safe for its intended application under normal usage conditions. The FM3280 complies with IEC 62471:2006 for LED safety. However, the user should avoid looking into the beam.

Depth of Field

The tables below list the depth of field tested in the 0lx and 300lx natural light.

Table 3-1

Ambient light: 0lux natural light

| Symbology | Near | Far |
|------------------|------|-------|
| EAN-13 (13mil) | 0mm | 290mm |
| Code 39 (20mil) | 15mm | 310mm |
| Code 128 (10mil) | 0mm | 280mm |
| QR Code (20mil) | 0mm | 270mm |

Table 3-2

Ambient light: 300lux natural light

| Symbology | Near | Far |
|------------------|------|-------|
| EAN-13 (13mil) | 0mm | 290mm |
| Code 39 (20mil) | 15mm | 310mm |
| Code 128 (10mil) | 0mm | 280mm |
| QR Code (20mil) | 0mm | 270mm |

Note: Depth of field is tested when the illumination brightness is set as level 2.

Chapter 4 Electrical Specifications

Power Supply

Do not power up the FM3280 until it is properly connected. Be sure the power is cut off before connecting a cable to or disconnecting a cable from the host interface connector. Hot-plugging could damage the scanner.

Unstable power supply or sharp voltage drops or unreasonably short interval between power-ons may lead to unstable performance of the scanner. Do not resupply the power immediately after cutting it off.



1. When designing, the user should ensure that the input power of FM3280 is fully decoupled. It is recommended to place a 22uF and a 100nF X5R or X7R ceramic capacitor beside the power input pin on the connector which is soldered on the board.
2. Ensure that the input power drops below 0.5V before powering the FM3280 on again, otherwise it will lead to abnormal function.

Ripple Noise

To ensure the image quality, a power supply with low ripple noise is needed.

Acceptable ripple range (peak-to-peak) $\leq 80\text{mV}$

Interface Pinouts

The following tables list the pin functions of the RJ50 port.

Table 4-1 USB+RS-232

| PIN# | Signal | I/O | Function |
|------|-----------|-----|---|
| 1 | EXT_DSF# | O | Good Read LED signal output, configured as active high or active low. Default: pull up. For more details, please refer to the Good Read Signal section in Chapter 8 and the Factory Defaults Table. |
| 2 | EXT_TRIG# | I | External trigger input signal, active low |
| 3 | VCC | - | Power input |
| 4 | RS232_TX | O | RS-232 output |
| 5 | RS232_RX | I | RS-232 input |
| 6 | RS232_CTS | I | RS-232 clear to send |
| 7 | RS232_RTS | O | RS-232 request to send |
| 8 | GND | - | Ground |
| 9 | USB_D- | I/O | USB_D- signal |
| 10 | USB_D+ | I/O | USB_D+ signal |

Table 4-2 USB+RS-485+Wiegand

| PIN# | Signal | I/O | Function |
|------|-----------|-----|---|
| 1 | EXT_DSF# | O | Good Read LED signal output, configured as active high or active low. Default: pull up. For more details, please refer to the Good Read Signal section in Chapter 8 and the Factory Defaults Table. |
| 2 | EXT_TRIG# | I | External trigger input signal, active low |
| 3 | VCC | - | Power input |
| 4 | RS-485- | I/O | RS-485- signal |
| 5 | RS-485+ | I/O | RS-485+ signal |
| 6 | WG_D0 | OC | Wiegand D0, pull-up by the host |
| 7 | WG_D1 | OC | Wiegand D1, pull-up by the host |
| 8 | GND | - | Ground |
| 9 | USB_D- | I/O | USB_D- signal |
| 10 | USB_D+ | I/O | USB_D+ signal |

DC Characteristics

Operating Voltage

Table 4-3

T=25°C

| Parameter | Description | Minimum | Typical | Maximum | Unit |
|-----------|--------------------------|---------|---------|---------|------|
| VCC | Input Voltage (5-24V) | 4.75 | 5 | 25.2 | V |

Operating Current

Table 4-4

VCC=5V, T=25°C

| Mode | | Typical | Maximum | Unit |
|--------------------------------------|-------------------|---------|---------|------|
| Working Current (non-NFC version) | RMS ¹ | 172 | 350 | mA |
| | PEAK ² | - | 500 | mA |
| Idle Current (non-NFC version) | RMS | 118 | - | mA |
| Working Current (NFC version) | RMS ¹ | 220 | 400 | mA |
| | PEAK ² | - | 500 | mA |
| Idle Current (NFC version) | RMS | 175 | - | mA |

1. RMS indicates the RMS value of the current under the stable working state.

2. PEAK indicates the peak current the device reaches.

I/O Voltage

Table 4-5

VCC=5V, GND =0V, T=25°C

(only for EXT_DSF# and EXT_TRIG# signal)

| Parameter | Description | Minimum | Maximum | Unit |
|-----------|-------------------|---------|---------|------|
| VIL | input low level | 0 | 0.3 | V |
| VIH | input high level | 3.0 | 3.3 | V |
| VOL | output low level | 0 | 0.3 | V |
| VOH | output high level | 3.0 | 3.3 | V |

Chapter 5 Auxiliary Tools

EasySet

EasySet, developed by Fujian Newland Auto-ID Tech. Co., Ltd., is a configuration tool for Newland's 1D/2D handheld barcode scanner, fixed mount barcode scanners and OEM scan engines. Its main features include:

- ✧ View device & configuration information of online device
- ✧ Configure device
- ✧ Update firmware of online device
- ✧ Load/modify existing XML configuration file; save current settings to an XML file
- ✧ Create/print/save programming barcodes to a PDF or Word file
- ✧ View/edit/save image stored on online device in the original image/BMP/JPG/TIFF format
- ✧ Send serial commands to online device and receive device response
- ✧ Supported languages: Chinese and English

EasySet supports 32-bit/64-bit Microsoft WinXP/Win7/Win 8/Win 8.1/Win 10 operating systems.

EasySet can communicate with device via one of the following interface: TTL-232, USB COM Port Emulation (UFCOM driver required), USB CDC (UFCOM driver required), USB DataPipe (UFCOM driver required), USB HID-POS.

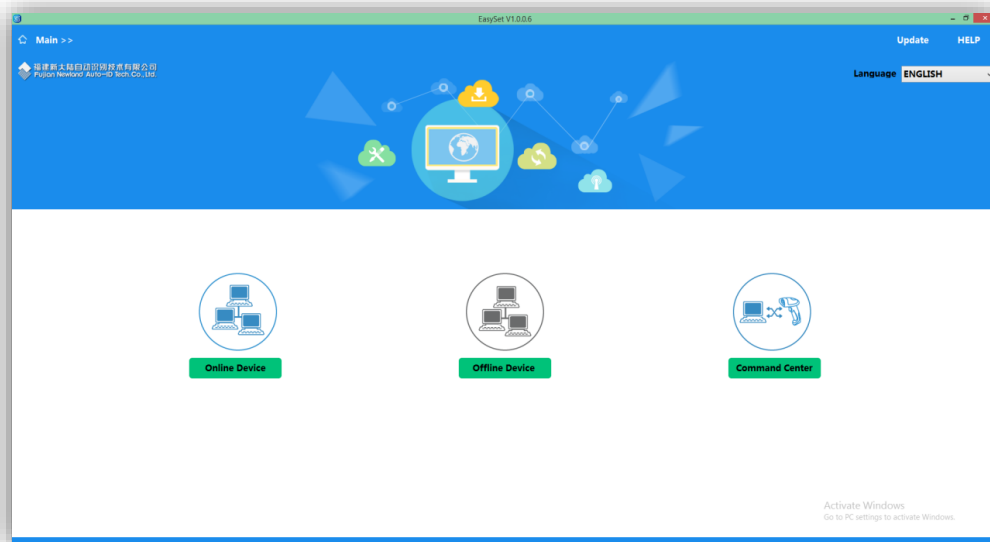

UFCOM

UFCOM, developed by Fujian Newland Auto-ID Tech. Co., Ltd., is a virtual serial driver. It is used in conjunction with a USB scanner or a scan engine configured as virtual serial port to provide two-way communication between the device and the host. UFCOM can run on all versions of Windows XP ~ Windows 10 x86 & x64, including the contemporary versions of Windows Server. Users can download the driver from the website at: <http://down.nlscan.com:82/Release/UFCOM/>.



@SETUPE1
Enter Setup

Chapter 6 Configuration

Introduction

There are three ways to configure the FM3280: Barcode programming, command programming and Easyset programming.

Barcode Programming

The FM3280 can be configured by scanning programming barcodes. All user programmable features/options are described along with their programming barcodes/commands in the following sections.

This programming method is most straightforward. However, it requires manually scanning barcodes. As a result, errors are more likely to occur.

Command Programming

The FM3280 can also be configured by serial commands sent from the host device.

Users can design an application program to send those command strings to the scanners to perform device configuration.

EasySet Programming

Besides the two methods mentioned above, you can conveniently perform scanner configuration through EasySet too. EasySet is a Windows-based configuration tool particularly designed for Newland products, enabling users to gain access to decoded data and captured images and to configure scanners. For more information about this tool, refer to the *EasySet User Guide*.

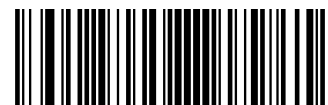

@SETUPE0
** Exit Setup



@SETUPE1
Enter Setup

Programming Barcode/ Programming Command/Function



The figure above is an example that shows you the programming barcode and command for the Enter Setup function:

1. The **No Case Conversion** barcode.
2. The **No Case Conversion** command.
3. The description of feature/option.



@SETUPE0
** Exit Setup



@SETUPE1
Enter Setup

Use of Programming Barcodes

Scanning the **Enter Setup** barcode can enable the scanner to enter the setup mode. Then you can scan a number of programming barcodes to configure your scanner. To exit the setup mode, scan the **Exit Setup** barcode or a non-programming barcode, or reboot the scanner.



@SETUPE0
Exit Setup



@SETUPE1
Enter Setup

Programming barcode data (i.e. the characters under programming barcode) can be transmitted to the host device. Scan the appropriate barcode below to enable or disable the transmission of programming barcode data to the host device.



@SETUPT0
Do Not Transmit Programming Barcode Data



@SETUPT1
Transmit Programming Barcode Data



@SETUPE0
**** Exit Setup**



@SETUPE1
Enter Setup

Default Settings

Factory Defaults

Scanning the following barcode can restore the scanner to the factory defaults.

You may need to reset all parameters to the factory defaults when:

- ✧ scanner is not properly configured so that it fails to decode barcodes.
- ✧ you forget previous configuration and want to avoid its impact.



@FACDEF
Restore All Factory Defaults

Custom Defaults

Scanning the **Restore All Custom Defaults** barcode can reset all parameters to the custom defaults. Scanning the **Save as Custom Defaults** barcode can set the current settings as custom defaults.

Custom defaults are stored in the non-volatile memory.



@CUSSAV
Save as Custom Defaults



@CUSDEF
Restore All Custom Defaults



Restoring the scanner to the factory defaults will not remove the custom defaults from the scanner.



@SETUPE0
**** Exit Setup**



@SETUPE1
Enter Setup

Query Product Information

After scanning the barcode below, the product information (including product name, firmware version, decoder version, hardware version, serial number, OEM serial number and manufacturing date) will be sent to the host device.



@QRYSYS
Query Product Information

Query Product Name



@QRYPDN
Query Product Name

Query Firmware Version



@QRYFWV
Query Firmware Version



@SETUPE0
**** Exit Setup**



@SETUPE1
Enter Setup

Query Hardware Version



@QRYHWW
Query Hardware Version

Query Product Serial Number



@QRYPSN
Query Product Serial Number



@SETUPE0
**** Exit Setup**



@SETUPE1
Enter Setup

Query Manufacturing Date



@QRYDAT
Query Manufacturing Date

Query OEM Serial Number



@QRYESN
Query OEM Serial Number

Query Data Formatter Version



@QRYDFM
Query Data Formatter Version

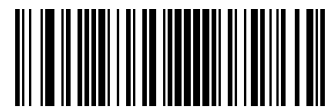

@SETUPE0
**** Exit Setup**



@SETUPE1
Enter Setup

Self-check Function

The self-check function is initiated by the person, and the scanner will automatically enter the self-check state. The scanner will check the peripheral like beeper, illumination, indicators and internal functions, which will last for seconds. The scanner finally will transmit the result to the host and exit the self-check state. Note that the scanner is unable to read barcodes and receive data from the host when it is in the self-check state.

Enable Self-Check Function

If there is any malfunction, you can enable the self-check function by scanning the Enter the Self-Check State barcode, and then contact and send the result to us.



@CHSDEV
Enter the Self-Check State



@SETUPE0
**** Exit Setup**



@SETUPE1

Enter Setup



@SETUPE0

**** Exit Setup**



@SETUPE1
Enter Setup

Chapter 7 Communication Interface

Introduction

- ✧ Serial communication interface is usually used when connecting the scanner to a host device (like PC, POS). You need to set communication parameters to match the host device.
- ✧ USB HID Keyboard: The scanner's transmission is simulated as USB keyboard input with no need for command configuration or a driver. Barcode data could be entered by the virtual keyboard directly and it is also convenient for the host device to receive data.
- ✧ USB CDC: It is compliant with the standard USB CDC class specifications defined by the USB-IF and allows the host device to receive data in the way as a serial port does. A driver is needed when using this feature.
- ✧ HID POS (POS HID Barcode Scanner): It is based on the HID interface, with no need for a custom driver. It excels virtual keyboard and traditional TTL-232 interface in transmission speed.
- ✧ IBM SurePOS: It conforms to IBM (now Toshiba Global Commerce Solutions) 4698 USB scanner interface specifications.

When the scanner is connected to both USB and RS-232 ports on a host device, it will select the USB connection by default.



@SETUPE0
** Exit Setup



@SETUPE1

Enter Setup

Adaptive Wired Communication

When this feature is on, the scanner can automatically adapt its communication configuration to the way it is connected to the host device: Automatically enable USB/serial communication when connected to the host device via USB/serial port, respectively.

Note: You must restart the scanner before this setting will take effect.

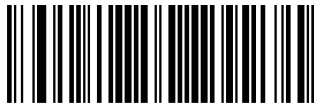

@AUTOUR0

Off



@AUTOUR1

On

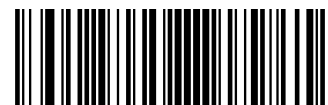

@SETUPE0

**** Exit Setup**



@SETUPE1

Enter Setup

RS-232 Interface

Serial communication interface is usually used when connecting the scanner to a host device (like PC, POS). However, to ensure smooth communication and accuracy of data, you need to set communication parameters (including baud rate, parity check, data bit and stop bit) to match the host device.



@INTERF0

RS-232



@SETUPE0

**** Exit Setup**



@SETUPE1
Enter Setup

Baud Rate

Baud rate is the number of bits of data transmitted per second. Set the baud rate to match the host requirements.



@232BAD8
115200



@232BAD7
57600



@232BAD6
38400



@232BAD5
19200



@232BAD4
14400



@232BAD3
9600



@232BAD2
4800

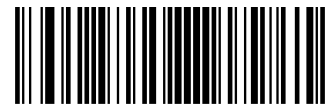

@SETUPE0
**** Exit Setup**



@SETUPE1
Enter Setup



@232BAD1
2400



@232BAD0
1200

Parity Check

Set the parity type to match the host requirements.

Odd Parity: If the data contains an odd number of 1 bits, the parity bit value is set to 0.

Even Parity: If the data contains an even number of 1 bits, the parity bit value is set to 0.

None: Select this option when no parity bit is required.



@232PAR0
None



@232PAR1
Even Parity



@232PAR2
Odd Parity



@SETUPE0
**** Exit Setup**



@SETUPE1
Enter Setup

Data Bit

Set the number of data bits to match the host requirements.



@232DAT1
7 Data Bits



@232DAT0
8 Data Bits

Stop Bit

The stop bit(s) at the end of each transmitted character marks the end of transmission of one character and prepares the receiving device for the next character in the serial data stream. Set the number of stop bits to match the host requirements.



@232STP0
1 Stop Bit



@232STP1
2 Stop Bits



@SETUPE0
**** Exit Setup**



@SETUPE1
Enter Setup

Hardware Auto Flow Control

If this feature is enabled, the scanner determines whether to transmit data based on CTS signal level. When CTS signal is at a low level which means the serial port's cache memory of receiving device (such as PC) is full, the scanner sends data through RS-232 port until CTS signal is set to high level by receiving device. When the scanner is not ready for receiving, it will set RTS signal to low level. When sending device (such as PC) detects it, it will not send data to the scanner any more to prevent data loss.

If this feature is disabled, reception/transmission of serial data will not be influenced by RTS/CTS signal.



@232AFL0
Disable Hardware Auto Flow Control



@232AFL1
Enable Hardware Auto Flow Control



Before enabling this feature, make sure that RTS/CTS signal lines are contained in RS-232 cable. Without the signal lines, RS-232 communication errors will occur.



@SETUPE0
**** Exit Setup**



@SETUPE1
Enter Setup

RS-485 Interface

When connecting the scanner to a host device (like PC, POS) via the RS-485 interface, you need to set communication parameters (including baud rate, parity check, data bit and stop bit) to match the host device. For setting parameters, please refer to the RS-232 Interface section. Note that hardware auto flow control is invalid for the RS-485 interface.



@INTERF20
RS-485 Interface

Slave Mode



@485SSM0
Multi-slave Mode



@485SSM1
Single Slave Mode

Set the Slave Address



@485ADD
Set the Slave Address

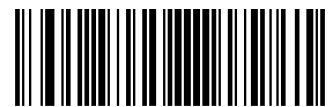

@SETUPE0
**** Exit Setup**



@SETUPE1
Enter Setup



Set the slave address as 0x20:

1. Scan the **Enter Setup** barcode.
2. Scan the **Set the Slave Address** barcode.
3. Scan the numeric barcodes “2” and “0” from the “Digit Barcodes” section in Appendix.
4. Scan the **Save** barcode from the “Save/Cancel Barcodes” section in Appendix.
5. Scan the **Exit Setup** barcode.



Ensure that the scanner is equipped the RS-485 interface, otherwise the RS-485 function is not available.



@SETUPE0
**** Exit Setup**



@SETUPE1
Enter Setup

Wiegand Interface



@INTERF16

Wiegand Interface

Wiegand Format



@WGDFMT1

34-bit

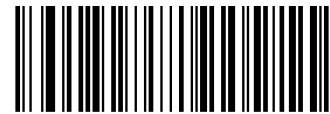

@WGDFMT0

26-bit



Ensure that data length is a multiple of 8 when transmitting data. If any abnormal beep is emitted out, please check whether the transmitted data length meets the demands or whether prefix and suffix functions are enabled.

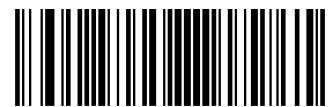

@SETUPE0
**** Exit Setup**



@SETUPE1
Enter Setup

USB HID Keyboard

When the scanner is connected to the USB port on a host device, you can enable the USB HID Keyboard feature by scanning the barcode below. Then scanner's transmission will be simulated as USB keyboard input. The Host receives keystrokes on the virtual keyboard. It works on a Plug and Play basis and no driver is required.



@INTERF3
USB HID Keyboard



If the host device allows keyboard input, then no extra software is needed for HID Keyboard input.



@SETUPE0
**** Exit Setup**



@SETUPE1
Enter Setup

USB Country Keyboard Types

Keyboard layouts vary from country to country. The default setting is U.S. keyboard.



@KBWCTY0
U.S. (English)



@KBWCTY1
Belgium



@KBWCTY2
Brazil



@KBWCTY3
Canada (French)



@KBWCTY4
Czechoslovakia



@KBWCTY5
Denmark



@KBWCTY6
Finland (Swedish)

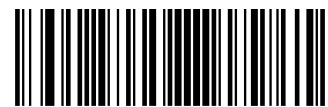

@SETUPE0
**** Exit Setup**



@SETUPE1
Enter Setup



@KBWCTY7
France



@KBWCTY8
Germany/ Austria

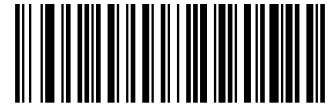

@KBWCTY9
Greece



@KBWCTY10
Hungary



@KBWCTY11
Israel (Hebrew)

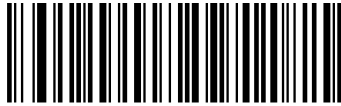

@KBWCTY12
Italy



@KBWCTY13
Latin America/ South America

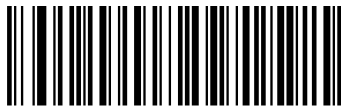

@KBWCTY14
Netherlands (Dutch)



@SETUPE0
**** Exit Setup**



@SETUPE1
Enter Setup



@KBWCTY15
Norway



@KBWCTY16
Poland



@KBWCTY17
Portugal



@KBWCTY18
Romania



@KBWCTY19
Russia



@KBWCTY21
Slovakia



@KBWCTY22
Spain



@KBWCTY23
Sweden

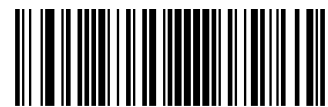

@SETUPE0
**** Exit Setup**



@SETUPE1
Enter Setup



@KBWCTY24
Switzerland (German)



@KBWCTY25
Turkey_F



@KBWCTY26
Turkey_Q



@KBWCTY27
UK



@KBWCTY28
Japan



@SETUPE0
**** Exit Setup**



@SETUPE1
Enter Setup

Beep on Unknown Character

Due to the differences in keyboard layouts, some characters contained in barcode data may be unavailable on the selected keyboard. As a result, the scanner fails to transmit the unknown characters.

Scan the appropriate barcode below to enable or disable the emission of beep when an unknown character is detected.



@KBWBUC0

Do Not Beep on Unknown Character



@KBWBUC1

Beep on Unknown Character



Supposing French keyboard (Country Code: 7) is selected and barcode data "ADF" is being dealt with, the keyboard will fail to locate the "Ð" (0xD0) character and the scanner will ignore the character and continue to process the next one.

Do Not Beep on Unknown Character: The scanner does not beep and the Host receives "AF".

Beep on Unknown Character: The scanner beeps and the Host still receives "AF".



If **Emulate ALT+Keypad ON** is selected, **Beep on Unknown Character** does not function.

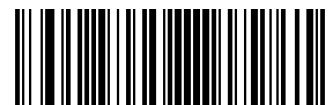

@SETUPE0
** Exit Setup



@SETUPE1
Enter Setup

Emulate ALT+Keypad

When **Emulate ALT+Keypad** is turned on, ASCII characters (0x20 - 0xFF) are sent over the numeric keypad no matter which keyboard type is selected.

1. ALT Make
2. Enter the number corresponding to a desired character on the keypad.
3. ALT Break

After **Emulate ALT+Keypad ON** is selected, you need to choose the code page with which the barcodes were created and to turn **Unicode Encoding** On or Off depending on the encoding used by the application software.

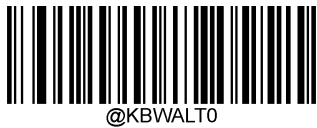

@KBWALTO
Emulate ALT+Keypad OFF

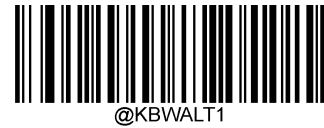

@KBWALT1
Emulate ALT+Keypad ON



Since sending a character involves multiple keystroke emulations, this method appears less efficient.



Supposing **Emulate ALT+Keypad** is ON, **Unicode Encoding** is Off, **Code Page 1252 (West European Latin)** is selected, and **Emulate Keypad with Leading Zero** is Off, barcode data "ADF" (65/208/70) is sent as below:

"A" -- "ALT Make" + "065" + "ALT Break"

"D" -- "ALT Make" + "208" + "ALT Break"

"F" -- "ALT Make" + "070" + "ALT Break"



@SETUPE0
**** Exit Setup**



@SETUPE1
Enter Setup

Code Page

Code pages define the mapping of character codes to characters. If the data received does not display with the proper characters, it may be because the barcode being scanned was created using a code page that is different from the one the host program is expecting. If this is the case, select the code page with which the barcodes were created by scanning the appropriate barcode below. For PDF417, QR Code and Data Matrix, besides setting the code page, you also need to set the character encoding in the "Character Encoding" section in Chapter 6. This feature is only effective when **Emulate ALT+Keypad** is turned on.

Note: Code Page 932, Code Page 936 and Code Page 950 are selectable and respectively supported by different software versions.



@KBWCPG0

Code Page 1252 (West European Latin)



@KBWCPG1

Code Page 1251 (Cyrillic)



@KBWCPG2

Code Page 1250 (Central and East European Latin)



@KBWCPG3

Code Page 1253 (Greek)



@KBWCPG4

Code Page 1254 (Turkish)



@KBWCPG5

Code Page 1255 (Hebrew)

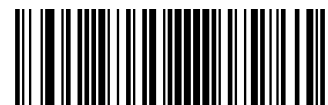

@SETUPE0

**** Exit Setup**



@SETUPE1
Enter Setup



@KBWCPG6
Code Page 1256 (Arabic)



@KBWCPG8
Code Page 1258 (Vietnamese)



@KBWCPG10
Code Page 950 (Traditional Chinese, Big5)



@KBWCPG12
Code Page 932 (Japanese, Shift-JIS)



@KBWCPG7
Code Page 1257 (Baltic)



@KBWCPG9
Code Page 936 (Simplified Chinese, GB2312,GBK)



@KBWCPG11
Code Page 874 (Thai)



@SETUPE0
**** Exit Setup**



@SETUPE1
Enter Setup

Unicode Encoding

Different host program may use different character encodings for handling incoming barcode data. For instance, Microsoft Office Word uses Unicode encoding and therefore you should turn **Unicode Encoding** on, whereas Microsoft Office Excel or Notepad uses Code Page encoding and therefore you should turn **Unicode Encoding** off. This feature is only effective when **Emulate ALT+Keypad** is turned on.



@KBWCPU0
Off



@KBWCPU1
On

Emulate Keypad with Leading Zero

You may turn this feature on to send character sequences sent over the numeric keypad as ISO characters which have a leading zero. For example, ASCII A transmits as "ALT MAKE" 0065 "ALT BREAK". This feature is only effective when **Emulate ALT+Keypad** is enabled.



@KBWALZ1
On



@KBWALZ0
Off



@SETUPE0
**** Exit Setup**



@SETUPE1
Enter Setup

Function Key Mapping

When **Ctrl+ASCII Mode** is selected, function characters (0x00 - 0x1F) are sent as ASCII sequences.



@KBWFKM0
Disable



@KBWFKM1
Ctrl+ASCII Mode



@KBWFKM2
Alt+Keypad Mode



If **Ctrl+ASCII Mode** is selected and other parameters of USB HID Keyboard adopt factory defaults, barcode data “A<HT>(i.e. Horizontal Tab)F” (0x41/0x09/0x46) is sent as below:

“A” - Keystroke “A”.

<HT> - “Ctrl Make” + Keystroke “I” + “Ctrl Break”

“F” - Keystroke “F”

For some text editors, “Ctrl I” means italic convert. So the output may be “*A*”.

If **Alt+Keypad Mode** is selected and other parameters of USB HID Keyboard adopt factory defaults, the data above is sent as below:

“A” - Keystroke “A”.

<HT> - “Alt Make” + Keystrokes “009” + “Alt Break”

“F” - Keystroke “F”



@SETUPE0
** Exit Setup



@SETUPE1
Enter Setup

ASCII Function Key Mapping Table

| ASCII Function | ASCII Value (HEX) | Function Key Mapping Disabled | Ctrl+ASCII |
|----------------|-------------------|-------------------------------|------------|
| NUL | 00 | Null | Ctrl+@ |
| SOH | 01 | Keypad Enter | Ctrl+A |
| STX | 02 | Caps Lock | Ctrl+B |
| ETX | 03 | ALT | Ctrl+C |
| EOT | 04 | Null | Ctrl+D |
| ENQ | 05 | CTRL | Ctrl+E |
| ACK | 06 | Null | Ctrl+F |
| BEL | 07 | Enter | Ctrl+G |
| BS | 08 | Left Arrow | Ctrl+H |
| HT | 09 | Horizontal Tab | Ctrl+I |
| LF | 0A | Down Arrow | Ctrl+J |
| VT | 0B | Vertical Tab | Ctrl+K |
| FF | 0C | Delete | Ctrl+L |
| CR | 0D | Enter | Ctrl+M |
| SO | 0E | Insert | Ctrl+N |
| SI | 0F | Esc | Ctrl+O |
| DLE | 10 | F11 | Ctrl+P |
| DC1 | 11 | Home | Ctrl+Q |
| DC2 | 12 | Print Screen | Ctrl+R |
| DC3 | 13 | Backspace | Ctrl+S |
| DC4 | 14 | tab+shift | Ctrl+T |
| NAK | 15 | F12 | Ctrl+U |
| SYN | 16 | F1 | Ctrl+V |
| ETB | 17 | F2 | Ctrl+W |
| CAN | 18 | F3 | Ctrl+X |
| EM | 19 | F4 | Ctrl+Y |
| SUB | 1A | F5 | Ctrl+Z |
| ESC | 1B | F6 | Ctrl+[|
| FS | 1C | F7 | Ctrl+\ |
| GS | 1D | F8 | Ctrl+] |
| RS | 1E | F9 | Ctrl+6 |
| US | 1F | F10 | Ctrl+- |



@SETUPE0
** Exit Setup



@SETUPE1
Enter Setup

ASCII Function Key Mapping Table (Continued)

The last five characters (0x1B~0x1F) in the table above apply to US keyboard layout only. The following chart provides the equivalents of these five characters for other countries.

| Country | Ctrl+ASCII | | | | | |
|----------------|------------|--------|---------|--------|--------|--|
| United States | Ctrl+[| Ctrl+\ | Ctrl+] | Ctrl+6 | Ctrl+- | |
| Belgium | Ctrl+[| Ctrl+< | Ctrl+] | Ctrl+6 | Ctrl+- | |
| Scandinavia | Ctrl+8 | Ctrl+< | Ctrl+9 | Ctrl+6 | Ctrl+- | |
| France | Ctrl+^ | Ctrl+8 | Ctrl+\$ | Ctrl+6 | Ctrl+= | |
| Germany | | Ctrl+Ã | Ctrl++ | Ctrl+6 | Ctrl+- | |
| Italy | | Ctrl+\ | Ctrl++ | Ctrl+6 | Ctrl+- | |
| Switzerland | | Ctrl+< | Ctrl+.. | Ctrl+6 | Ctrl+- | |
| United Kingdom | Ctrl+[| Ctrl+∅ | Ctrl+] | Ctrl+6 | Ctrl+- | |
| Denmark | Ctrl+8 | Ctrl+\ | Ctrl+9 | Ctrl+6 | Ctrl+- | |
| Norway | Ctrl+8 | Ctrl+\ | Ctrl+9 | Ctrl+6 | Ctrl+- | |
| Spain | Ctrl+[| Ctrl+\ | Ctrl+] | Ctrl+6 | Ctrl+- | |



@SETUPE0
** Exit Setup



@SETUPE1
Enter Setup

Inter-Keystroke Delay

This parameter specifies the delay between emulated keystrokes.



@KBWDLY0
No Delay



@KBWDLY40
Long Delay (40ms)



@KBWDLY20
Short Delay (20ms)



@SETUPE0
**** Exit Setup**



@SETUPE1
Enter Setup

Caps Lock

The **Caps Lock On** options can invert upper and lower case characters contained in barcode data. This inversion occurs regardless of the state of Caps Lock key on the host device's keyboard. To disable this feature, scan the appropriate **Caps Lock OFF** barcode below based on your keyboard.



@KBWCAP0

Caps Lock OFF, Non-Japanese Keyboard



@KBWCAP1

Caps Lock ON, Non-Japanese Keyboard



@KBWCAP2

Caps Lock OFF, Japanese Keyboard



@KBWCAP3

Caps Lock ON, Japanese Keyboard



Emulate ALT+Keypad ON/ Convert All to Upper Case/ Convert All to Lower Case prevails over **Caps Lock ON**.



When the **Caps Lock ON** feature is selected, barcode data "AbC" is transmitted as "aBc".



@SETUPE0
**** Exit Setup**



@SETUPE1
Enter Setup

Convert Case

Scan the appropriate barcode below to convert all bar code data to your desired case.



@KBWCAS0
No Case Conversion

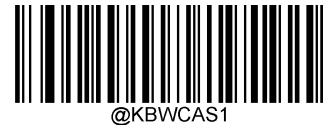

@KBWCAS1
Convert All to Upper Case



@KBWCAS2
Convert All to Lower Case



When the **Convert All to Lower Case** feature is enabled, barcode data “AbC” is transmitted as “abc”.



If **Emulate ALT+Keypad ON** is selected, **Convert All to Lower Case** and **Convert All to Upper Case** do not function.

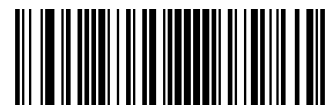

@SETUPE0
**** Exit Setup**



@SETUPE1
Enter Setup

Emulate Numeric Keypad



Do Not Emulate Numeric Keypad 1: Sending a number (0-9) is emulated as keystroke(s) on main keyboard.

Emulate Numeric Keypad 1: Sending a number (0-9) is emulated as keystroke(s) on numeric keypad. The state of Num Lock on the simulated numeric keypad is determined by its equivalent on the host device. If Num Lock on the host device is turned off, the output of simulated numeric keypad is function key instead of number.

Do Not Emulate Numeric Keypad 2: Sending “+”, “-”, “*” and “/” is emulated as keystroke(s) on main keyboard.

Emulate Numeric Keypad 2: Sending “+”, “-”, “*” and “/” is emulated as keystroke(s) on numeric keypad.

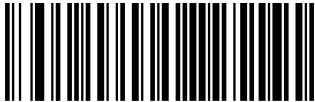

@KBWNUM0

Do Not Emulate Numeric Keypad 1



@KBWNUM1

Emulate Numeric Keypad 1



@SETUPE0
** Exit Setup



@SETUPE1
Enter Setup



@KBWNCH0
Do Not Emulate Numeric Keypad 2



@KBWNCH1
Emulate Numeric Keypad 2



Emulate ALT+Keypad ON prevails over **Emulate Numeric Keypad**.



Supposing the **Emulate Numeric Keypad 1** feature is enabled:

if Num Lock on the host device is ON, "A4.5" is transmitted as "A4.5";

if Num Lock on the host device is OFF, "A4.5" is transmitted as ".A":

1. "A" is sent on main keyboard;
2. "4" is sent as the function key "Cursor Move to Left";
3. "." is sent on main keyboard;
4. "5" is not sent as it does not correspond to any function key.

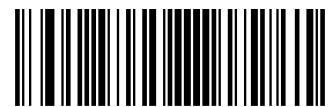

@SETUPE0
**** Exit Setup**



@SETUPE1
Enter Setup

Fast Mode

When **Fast Mode On** is selected, the scanner sends characters to the Host faster. If the Host drops characters, turn the Fast Mode off or change the polling rate to a bigger value.



@KBWFAS0
Fast Mode Off



@KBWFAS1
Fast Mode On



@SETUPE0
**** Exit Setup**



@SETUPE1

Enter Setup

Polling Rate

This parameter specifies the polling rate for a USB keyboard. If the Host drops characters, change the polling rate to a bigger value.



@KBWPOR0

1ms



@KBWPOR1

2ms



@KBWPOR2

3ms



@KBWPOR3

4ms



@KBWPOR4

5ms



@KBWPOR5

6ms



@KBWPOR6

7ms



@SETUPE0

**** Exit Setup**



@SETUPE1
Enter Setup



@KBWPOR7
8ms



@KBWPOR8
9ms



@KBWPOR9
10ms



@SETUPE0
**** Exit Setup**



@SETUPE1

Enter Setup

USB CDC

If your scanner is connected to the USB port on a host device, the USB CDC feature allows the host device to receive data in the way as a serial port does. A driver is needed when using this feature. You may download it from our website at www.newlandaidc.com.



@INTERF8

USB CDC

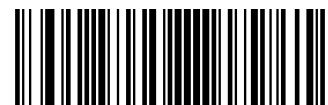

@SETUPE0

**** Exit Setup**



@SETUPE1
Enter Setup

HID POS (POS HID Barcode Scanner)

Introduction

The HID-POS interface is recommended for new application programs. It can send up to 56 characters in a single USB report and appears more efficient than keyboard emulation.

Features:

- ✧ HID based, no custom driver required.
- ✧ Way more efficient in communication than keyboard emulation and traditional TTL-232 interface.



@INTERF5
USB HID-POS

Access the Scanner with Your Program

Use CreateFile to access the scanner as a HID device and then use ReadFile to deliver the scanned data to the application program. Use WriteFile to send data to the scanner.

For detailed information about USB and HID interfaces, go to www.USB.org.



@SETUPE0
** Exit Setup



@SETUPE1
Enter Setup

Acquire Scanned Data

After a barcode is decoded, the scanner sends an input report as below:

| | Bit | | | | | | | |
|-------|---|---|---|---|---|---|---|------------------------|
| Byte | 7 | 6 | 5 | 4 | 3 | 2 | 1 | 0 |
| 0 | Report ID = 0x02 | | | | | | | |
| 1 | Barcode Length | | | | | | | |
| 2-57 | Decoded Data (1-56) | | | | | | | |
| 58-61 | Reserved | | | | | | | |
| 62 | Newland Symbology Identifier or N/C: 0x00 | | | | | | | |
| 63 | - | - | - | - | - | - | - | Decoded data continued |

Send Command to the Scanner

This output report is used to send commands to the scanner. All programming commands can be used.

| | Bit | | | | | | | |
|------|-------------------|---|---|---|---|---|---|---|
| Byte | 7 | 6 | 5 | 4 | 3 | 2 | 1 | 0 |
| 0 | Report ID = 0x04 | | | | | | | |
| 1 | Length of command | | | | | | | |
| 2-63 | Command (1-62) | | | | | | | |



@SETUPE0
** Exit Setup



@SETUPE1
Enter Setup

IBM SurePOS (Tabletop)



@INTERF6
IBM SurePOS (Tabletop)

IBM SurePOS (Handheld)



@INTERF7
IBM SurePOS (Handheld)



@SETUPE0
** Exit Setup



@SETUPE1
Enter Setup

Datalogic Magellan Aux-RS232

Scan the following barcode when connecting to the Datalogic Magellan device, and the configuration of the scanner will be automatically changed accordingly as below.



Datalogic Magellan Aux-RS232

| Functions | | Configuration |
|------------------|-----------------------------|----------------------------|
| RS-232 Interface | Baud Rate | 9600 |
| | Parity Check | None |
| | Data Bit | 8 Data Bits |
| | Stop Bit | 1 Stop Bit |
| | Hardware Auto Flow Control | Enabled |
| Code 128 | Code ID | # |
| | Enable/Disable Code 128 | Enabled |
| EAN-8 | Code ID | FF |
| | Enable/Disable EAN-8 | Enabled |
| | Transmit Check Character | Transmit |
| | 2-Digit Add-On Code | Enable 2-Digit Add-On Code |
| | 5-Digit Add-On Code | Enable 5-Digit Add-On Code |
| EAN-13 | Code ID | F |
| | Enable/Disable EAN-13 | Enabled |
| | Transmit Check Character | Transmit |
| | 2-Digit Add-On Code | Enable 2-Digit Add-On Code |
| | 5-Digit Add-On Code | Enable 5-Digit Add-On Code |
| UPC-E | Code ID | E |
| | Enable/Disable UPC-E | Enabled |
| | Transmit Check Character | Transmit |
| | 2-Digit Add-On Code | Enable 2-Digit Add-On Code |
| | 5-Digit Add-On Code | Enable 5-Digit Add-On Code |
| | Transmit Preamble Character | System Character |
| UPC-A | Code ID | A |
| | Enable/Disable UPC-A | Enabled |
| | Transmit Check Character | Transmit |



@SETUPE0
** Exit Setup



@SETUPE1

Enter Setup

| | | |
|--------------------|--------------------------------------|---|
| | 2-Digit Add-On Code | Enable 2-Digit Add-On Code |
| | 5-Digit Add-On Code | Enable 5-Digit Add-On Code |
| | Transmit Preamble Character | System Character |
| Interleaved 2 of 5 | Code ID | i |
| | Enable/Disable Interleaved 2 of 5 | Enabled |
| | Check Character Verification | Transmit Check Character After Verification |
| Code 39 | Code ID | * |
| | Enable/Disable Code 39 | Enabled |
| | Check Character Verification | Transmit Check Character After Verification |
| | Start/Stop Character | Transmit |
| Codabar | Code ID | % |
| | Enable/Disable Codabar | Enabled |
| | Check Character Verification | Disabled |
| | Transmit Start/Stop Character | Transmit |
| | Start/Stop Character | ABCD/ABCD |
| Code 93 | Code ID | & |
| | Enable/Disable Code 93 | Enabled |
| | Check Character Verification | Transmit Check Character After Verification |
| GS1 Databar | Code ID | R4 |
| | Enable/Disable GS1 Databar | Enabled |
| | Transmit Application Identifier "01" | Transmit |
| Standard 25 | Code ID | s |
| | Enable/Disable Standard 25 | Enabled |
| | Check Character Verification | Transmit Check Character After Verification |
| MSI-Plessey | Code ID | @ |
| | Enable/Disable MSI-Plessey | Enabled |
| | Check Character Verification | One Check Character, MOD10 |
| | Transmit Check Character | Transmit |
| PDF417 | Code ID | P |
| | Enable/Disable PDF417 | Enabled |
| Prefixes/ Suffixes | Code ID Prefix | Enabled |
| | Terminating Character Suffix | Disabled |



@SETUPE0

** Exit Setup



@SETUPE1
Enter Setup

VID/PID

USB uses VID (Vendor ID) and PID (Product ID) to identify and locate a device. The VID is assigned by USB Implementers Forum. Newland's vendor ID is 1EAB (Hex). A range of PIDs are used for each Newland product family. Every PID contains a base number and interface type (keyboard, COM port, etc.).

| Product | Interface | PID (Hex) |
|---------|------------------------|-----------|
| FM3280 | USB HID Keyboard | 4622 |
| | USB CDC | 4606 |
| | HID POS | 4610 |
| | IBM SurePOS (Tabletop) | 4620 |
| | IBM SurePOS(Handheld) | 4621 |



@SETUPE0
**** Exit Setup**



@SETUPE1
Enter Setup

Chapter 8 System Settings

Scan Mode

Level Mode: A trigger pull activates a decode session. The decode session continues until a barcode is decoded or you release the trigger.

Sense Mode: The scanner activates a decode session every time it detects a barcode presented to it. The decode session continues until a barcode is decoded or the decode session timeout expires. **Reread Timeout** can avoid undesired rereading of same barcode in a given period of time. **Sensitivity** can change the Sense Mode's sensibility to changes in images captured. **Image Stabilization Timeout** gives the scanner time to adapt to ambient environment after it decodes a barcode and "looks" for another.

Continuous Mode: The scanner automatically starts one decode session after another. To suspend/resume barcode reading, simply press the trigger. **Reread Timeout** can avoid undesired rereading of same barcode in a given period of time.



@SCNMOD0
Level Mode



@SCNMOD2
Sense Mode



@SCNMOD3
Continuous Mode



@SETUPE0
** Exit Setup



@SETUPE1
Enter Setup

Decode Session Timeout

This parameter sets the maximum time decode session continues during a scan attempt. It is programmable in 1ms increments from 1ms to 3,600,000ms. When it is set to 0, the timeout is infinite. This feature is only applicable to the Pulse, Sense and Level modes.

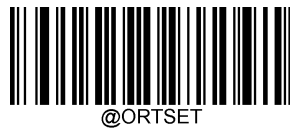

@ORTSET
Decode Session Timeout



Set the decode session timeout to 1,500ms:

1. Scan the **Enter Setup** barcode.
2. Scan the **Decode Session Timeout** barcode.
3. Scan the numeric barcodes “1”, “5”, “0” and “0” from the “Digit Barcodes” section in Appendix.
4. Scan the **Save** barcode from the “Save/Cancel Barcodes” section in Appendix.
5. Scan the **Exit Setup** barcode.

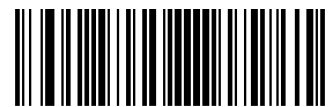

@SETUPE0
**** Exit Setup**



@SETUPE1
Enter Setup

Types of Triggering



@TRGSGN0
Low Level Triggering



@TRGSGN1
High Level Triggering

Debounce Time

Set the debounce time for the TRIG_IN signal.



@TBDDUR
Debounce Time



Set the debounce time to 20ms:

1. Scan the Enter Setup barcode.
2. Scan the **Debounce Time** barcode.
3. Scan the numeric barcodes “2” and “0” from the “Digit Barcodes” section in Appendix.
4. Scan the **Save** barcode from the “Save/Cancel Barcodes” section in Appendix.
5. Scan the **Exit Setup** barcode.



@SETUPE0
**** Exit Setup**



@SETUPE1

Enter Setup

Enter the Detection/ Reading State (Sense Mode)

Scan appropriate barcodes below to enable the scanner to enter the detection state or reading state after a good read. This feature is only applicable to the Sense mode.

Enter the Detection State: The scanner stops reading after a barcode is decoded or the decode session timeout expires, and then it starts reading the new barcode presented to it after the Image stabilization timeout expires.

Enter the Reading State: The scanner continues reading after a barcode is decoded or the decode session timeout expires.



@SENAGR0

Enter the Detection State



@SENAGR1

Enter the Reading State



@SETUPE0

**** Exit Setup**



@SETUPE1
Enter Setup

Image Stabilization Timeout (Sense Mode)

This parameter defines the amount of time the scanner will spend adapting to ambient environment after it decodes a barcode and “looks” for another. It is programmable in 1ms increments from 0ms to 3,000ms.



@SENIST
Image Stabilization Timeout



Set the image stabilization timeout to 800ms:

1. Scan the **Enter Setup** barcode.
2. Scan the **Image Stabilization Timeout** barcode.
3. Scan the numeric barcodes “8”, “0” and “0” from the “Digit Barcodes” section in Appendix.
4. Scan the **Save** barcode from the “Save/Cancel Barcodes” section in Appendix.
5. Scan the **Exit Setup** barcode.



@SETUPE0
**** Exit Setup**



@SETUPE1
Enter Setup

Trigger Selection (Sense Mode)



@SENTRG0
Image Change Trigger



@SENTRG1
IR Proximity Trigger



@SENTRG2
Both



@SETUPE0
**** Exit Setup**



@SETUPE1
Enter Setup

Image Change Trigger Sensitivity

This specifies the degree of acuteness of the scanner's response to changes in images captured. There are 20 levels to choose from. The smaller the value, the higher the sensitivity and the lower requirement in image change to trigger the scanner. You can select an appropriate degree of sensitivity that fits your application environment. This feature is only applicable to the Sense mode.



@SENLVL14
Low Sensitivity



@SENLVL11
Medium Sensitivity



@SENLVL8
High Sensitivity



@SENLVL5
Enhanced Sensitivity



@SENLVL
Custom Sensitivity (Level 1-20)

E
xample

Set the image change trigger sensitivity to Level 10:

1. Scan the **Enter Setup** barcode.
2. Scan the **Custom Sensitivity** barcode.
3. Scan the numeric barcodes "1" and "0" from the "Digit Barcodes" section in Appendix.
4. Scan the **Save** barcode from the "Save/Cancel Barcodes" section in Appendix.
5. Scan the **Exit Setup** barcode.



@SETUPE0
** Exit Setup



@SETUPE1
Enter Setup

IR Proximity Trigger Sensitivity

This specifies the degree of acuteness of the scanner's "sense" to detect barcodes presented to it. There are 10 levels to choose from. The smaller the value, the higher the sensitivity and the further the scanner can reach. You can select an appropriate degree of sensitivity that fits your application needs. This feature is only applicable to the Sense mode.

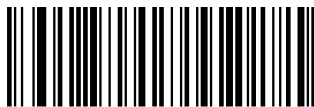

@SENIRL9
Low Sensitivity



@SENIRL6
Medium Sensitivity



@SENIRL3
High Sensitivity



@SENIRL
Custom Sensitivity (Level 1-10)

E
xample

Set the IR proximity trigger sensitivity to Level 10:

1. Scan the **Enter Setup** barcode.
2. Scan the **Custom Sensitivity** barcode.
3. Scan the numeric barcodes "1" and "0" from the "Digit Barcodes" section in Appendix.
4. Scan the **Save** barcode from the "Save/Cancel Barcodes" section in Appendix.
5. Scan the **Exit Setup** barcode.



@SETUPE0
**** Exit Setup**



@SETUPE1
Enter Setup

Illumination During the Detection State

On: Illumination LEDs are turned on when the scanner is in the detection state.

Off: Illumination LEDs are off when the scanner is in the detection state.

Breathing Light: Illumination LEDs are in the breathing pattern when the scanner is in the detection state.

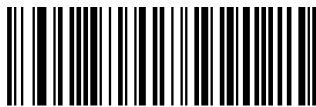

@SENILL1
On



@SENILL0
Off



@SENILL2
Breathing Light

Reread Timeout

Reread Timeout can avoid undesired rereading of same barcode in a given period of time. This feature is only applicable to the Sense and Continuous modes.

To enable/disable the Reread Timeout, scan the appropriate barcode below.

Enable Reread Timeout: Do not allow the scanner to re-read same barcode before the reread timeout expires.

Disable Reread Timeout: Allow the scanner to re-read same barcode.



@SETUPE0
** Exit Setup



@SETUPE1
Enter Setup



@RRDENA1
Enable Reread Timeout



@RRDENA0
Disable Reread Timeout

The following parameter sets the time interval between two successive reads on same barcode. It is programmable in 1ms increments from 0ms to 3,600,000ms. When it is set to a value greater than 3,000, the timeout for rereading same programming barcode is limited to 3,000ms.



@RRDDUR
Reread Timeout



Set the reread timeout to 1,000ms:

1. Scan the **Enter Setup** barcode.
2. Scan the **Reread Timeout** barcode.
3. Scan the numeric barcodes “1”, “0”, “0” and “0” from the “Digit Barcodes” section in Appendix.
4. Scan the **Save** barcode from the “Save/Cancel Barcodes” section in Appendix.
5. Scan the **Exit Setup** barcode.

You may wish to restart the reread timeout when the scanner encounters the same barcode that was decoded in the last scan session before the reread timeout expires. To enable this feature, scan the **Reread Timeout Reset On** barcode. This feature is only effective when **Reread Timeout** is enabled.

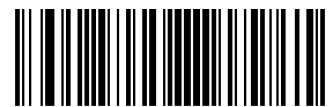

@SETUPE0
**** Exit Setup**



@SETUPE1

Enter Setup



@RRDREN1

Reread Timeout Reset On



@RRDREN0

Reread Timeout Reset Off



@SETUPE0

**** Exit Setup**



@SETUPE1
Enter Setup

Good Read Delay

Good Read Delay sets the minimum amount of time before the scanner can read another barcode after a good read. This parameter is programmable in 1ms increments from 1ms to 3,600,000ms. Scan the appropriate barcode below to enable or disable the delay.



@GRDNA1
Enable Good Read Delay



@GRDNA0
Disable Good Read Delay

To set the good read delay, scan the barcode below, then set the delay (from 1 to 3,600,000ms) by scanning the digit barcode(s) then scanning the **Save** barcode from the Appendix.



@GRDDUR
Good Read Delay



Set the good read delay to 1,000ms:

1. Scan the **Enter Setup** barcode.
2. Scan the **Good Read Delay** barcode.
3. Scan the numeric barcodes “1”, “0”, “0” and “0” from the “Digit Barcodes” section in Appendix.
4. Scan the **Save** barcode from the “Save/Cancel Barcodes” section in Appendix.
5. Scan the **Exit Setup** barcode.

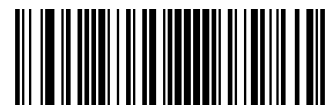

@SETUPE0
**** Exit Setup**



@SETUPE1
Enter Setup

Scanning Preference

Normal Mode: Select this mode when reading barcodes on paper.

Screen Mode: Select this mode when reading barcodes on the screen.

Barcode Pay Mode: Select this mode when reading barcodes to perform payment transactions.



@EXPLVL0
Normal Mode



@EXPLVL2
Screen Mode



@EXPLVL5
Barcode Pay Mode



@SETUPE0
** Exit Setup



@SETUPE1
Enter Setup

Scanning After Power-on

On: Barcode scanning is enabled after power-on.

Off: Barcode scanning is disabled after power-on.



@SCNPEN1
On

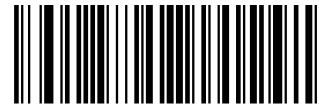

@SCNPEN0
Off

Decode Area

Whole Area Decoding: The scanner attempts to decode barcode(s) within its field of view, from the center to the periphery, and transmits the barcode that has been first decoded.

Specific Central Area Decoding: The scanner attempts to read barcode(s) whose center is within a specified decoding area and transmits the barcode that has been first decoded. This option allows the scanner to narrow its field of view to make sure it reads only those barcodes intended by the user. For instance, if multiple barcodes are placed closely together, specific area decoding in conjunction with appropriate pre-defined decoding area will insure that only the desired barcode is read.

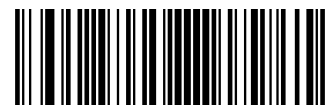

@SETUPE0
** Exit Setup



@SETUPE1

Enter Setup



@CADENA0

Whole Area Decoding



@CADENA1

Specific Central Area Decoding

If **Specific Central Area Decoding** is enabled, the scanner only reads barcodes that intersect the predefined decoding area.

You can define the decoding area using the **Top of Decoding Area**, **Bottom of Decoding Area**, **Left of Decoding Area** and **Right of Decoding Area** barcodes as well as numeric barcode(s) that represent(s) a desired percentage (0-100). The value of Bottom must be greater than that of Top; the value of Right must be greater than that of Left.



@CADTOP

Top of Decoding Area



@CADBOT

Bottom of Decoding Area



@CADLEF

Left of Decoding Area



@CADRIG

Right of Decoding Area



@SETUPE0

**** Exit Setup**



@SETUPE1
Enter Setup



Program the scanner to only read Barcode 1 in the figure above by setting the decoding area to 10% top, 45% bottom, 15% left and 30% right:

1. Scan the **Enter Setup** barcode.
2. Scan the **Top of Decoding Area** barcode.
3. Scan the numeric barcode "0" from the "Digit Barcodes" section in Appendix.
4. Scan the **Save** barcode from the "Save/Cancel Barcodes" section in Appendix.
5. Scan the **Bottom of Decoding Area** barcode.
6. Scan the numeric barcodes "4" and "5" from the "Digit Barcodes" section in Appendix.
7. Scan the **Save** barcode from the "Save/Cancel Barcodes" section in Appendix.
8. Scan the **Top of Decoding Area** barcode.
9. Scan the numeric barcodes "1" and "0" from the "Digit Barcodes" section in Appendix.
10. Scan the **Save** barcode from the "Save/Cancel Barcodes" section in Appendix.
11. Scan the **Left of Decoding Area** barcode.
12. Scan the numeric barcode "0" from the "Digit Barcodes" section in Appendix.
13. Scan the **Save** barcode from the "Save/Cancel Barcodes" section in Appendix.
14. Scan the **Right of Decoding Area** barcode.
15. Scan the numeric barcodes "3" and "0" from the "Digit Barcodes" section in Appendix.
16. Scan the **Save** barcode from the "Save/Cancel Barcodes" section in Appendix.
17. Scan the **Left of Decoding Area** barcode.
18. Scan the numeric barcodes "1" and "5" from the "Digit Barcodes" section in Appendix.
19. Scan the **Save** barcode from the "Save/Cancel Barcodes" section in Appendix.
20. Scan the **Exit Setup** barcode.

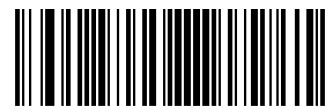

@SETUPE0
** Exit Setup



@SETUPE1
Enter Setup

Image Flipping



@MIRROR0
Do Not Flip



@MIRROR2
Flip Vertically



@MIRROR1
Flip Horizontally



@MIRROR3
Flip Horizontally & Vertically



@SETUPE0
** Exit Setup



@SETUPE1

Enter Setup

Example of image not flipped



Example of image flipped horizontally



Example of image flipped vertically



Example of image flipped horizontally & vertically



Bad Read Message

Scan the appropriate barcode below to select whether or not to send a bad read message (user-programmable) when a good read does not occur before trigger release, or the decode session timeout expires, or the scanner receives the **Stop Scanning** command (For more information, see the “Serial Trigger Command” section in this Chapter).



@NGRENA0

Bad Read Message OFF



@NGRENA1

Bad Read Message ON



@SETUPE0

**** Exit Setup**



@SETUPE1
Enter Setup

Set Bad Read Message

A bad read message can contain up to 7 characters (HEX values from 0x00 to 0xFF). To set a bad read message, scan the **Set Bad Read Message** barcode, the numeric barcodes representing the hexadecimal values of desired character(s) and the **Save** barcode.



@NGRSET
Set Bad Read Message



Set the bad read message to “F” (HEX: 0x46):

1. Scan the **Enter Setup** barcode.
2. Scan the **Set Bad Read Message** barcode.
3. Scan the numeric barcodes “4” and “6” from the “Digit Barcodes” section in Appendix.
4. Scan the **Save** barcode from the “Save/Cancel Barcodes” section in Appendix.
5. Scan the **Exit Setup** barcode.



@SETUPE0
**** Exit Setup**



@SETUPE1
Enter Setup

Good Read Signal

The SCAN_OK signal can be used to indicate a good read.

On: The SCAN_OK pin can be used to generate a good read indicator when a good read occurs.

Off: The SCAN_OK pin is unable to generate a good read indicator when a good read occurs.



@GRSENA0
Off



@GRSENA1
On

Polarity of Good Read Signal

Low Level: The SCAN_OK pin produces low level output when a good read occurs.

High Level: The SCAN_OK pin produces high level output when a good read occurs.

Note: You must restart the scanner before this setting will take effect.

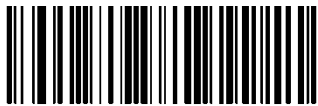

@GRSAPL0
Low Level

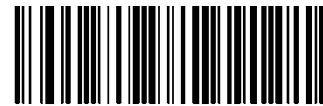

@GRSAPL1
High Level



@SETUPE0
**** Exit Setup**



@SETUPE1

Enter Setup

Good Read Indicator Duration

This parameter sets the amount of time that the Good Read Indicator to remain on following a good read. It is programmable in 1ms increments from 1ms to 10000ms.



@GRSDUR

Good Read Indicator Duration



Set the Good Read Indicator duration to 1500ms:

1. Scan the **Enter Setup** barcode.
2. Scan the **Good Read Indicator Duration** barcode.
3. Scan the numeric barcodes “1”, “5”, “0” and “0” from the “Digit Barcodes” section in Appendix.
4. Scan the **Save** barcode from the “Save/Cancel Barcodes” section in Appendix.
5. Scan the **Exit Setup** barcode.



@SETUPE0

**** Exit Setup**



@SETUPE1
Enter Setup

Trigger Commands

When **Enable Trigger Commands** is selected, you can activate and deactivate the scanner in the Level mode with serial trigger commands. Sending the **Start Scanning** command (default: **<SOH> T <EOT>**, user-programmable) to the scanner in the Level mode activates a decode session. The decode session continues until a barcode is decoded or the decode session timeout expires or the scanner receives the **Stop Scanning** command (default: **<SOH> P <EOT>**, user-programmable).



@SCNTCE0
Disable Trigger Commands



@SCNTCE1
Enable Trigger Commands

Modify Start Scanning Command

The **Start Scanning** command can consist of 1-10 characters (HEX values from 0x01 to 0xFF). In this command, the character “?” (HEX: 0x3F) cannot be the first character. The default **Start Scanning** command is **<SOH> T <EOT>**.



@SCNTCT
Modify Start Scanning Command



Set the Start Scanning command to “*T”:

1. Scan the **Enter Setup** barcode.
2. Scan the **Modify Start Scanning Command** barcode.
3. Scan the numeric barcodes “2”, “A”, “5” and “4” from the “Digit Barcodes” section in Appendix.
4. Scan the **Save** barcode from the “Save/Cancel Barcodes” section in Appendix.
5. Scan the **Exit Setup** barcode.



@SETUPE0
**** Exit Setup**



@SETUPE1
Enter Setup

Modify Stop Scanning Command

The **Stop Scanning** command can consist of 1-10 characters (HEX values from 0x01 to 0xFF). In this command, the character “?” (HEX: 0x3F) cannot be the first character. The default **Stop Scanning** command is <SOH> P <EOT>.



@SCNTCP
Modify Stop Scanning Command



Set the Stop Scanning command to “*P”:

1. Scan the **Enter Setup** barcode.
2. Scan the **Modify Stop Scanning Command** barcode.
3. Scan the numeric barcodes “2”, “A”, “5” and “0” from the “Digit Barcodes” section in Appendix.
4. Scan the **Save** barcode from the “Save/Cancel Barcodes” section in Appendix.
5. Scan the **Exit Setup** barcode.



@SETUPE0
**** Exit Setup**



@SETUPE1
Enter Setup

Illumination

A couple of illumination options are provided to improve the lighting conditions during every image capture:

Normal: Illumination LEDs are turned on during image capture.

Off: Illumination LEDs are off all the time.



@ILLSCN1
Normal



@ILLSCN0
Off

Illumination Brightness



@ILLBRL0
Level 1



@ILLBRL1
Level 2



@SETUPE0
**** Exit Setup**



@SETUPE1
Enter Setup

Illumination Color Selection



@ILLCLR1
White

Good Read LED

The green LED can be programmed to be On or Off to indicate good read.



@GRLENA1
On



@GRLENA0
Off



@SETUPE0
**** Exit Setup**



@SETUPE1
Enter Setup

Good Read LED Duration

This parameter sets the amount of time that the Good Read LED to remain on following a good read. It is programmable in 1ms increments from 1ms to 2,500ms.



@GRLDUR20
Short (20ms)



@GRLDUR120
Medium (120ms)



@GRLDUR220
Long (220ms)



@GRLDUR320
Prolonged (320ms)

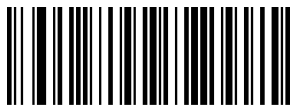

@GRLDUR
Custom (1 - 2,500ms)



Set the Good Read LED duration to 800ms:

6. Scan the **Enter Setup** barcode.
7. Scan the **Custom** barcode.
8. Scan the numeric barcodes “8”, “0” and “0” from the “Digit Barcodes” section in Appendix.
9. Scan the **Save** barcode from the “Save/Cancel Barcodes” section in Appendix.
10. Scan the **Exit Setup** barcode.



@SETUPE0
**** Exit Setup**



@SETUPE1
Enter Setup

Access Control Mode

- ◇ **Mode 0: normal**
- ◇ **Mode 1: not accessible, red LED on and unable to read barcodes**
- ◇ **Mode 2: accessible, green LED on and then off after a good read**
- ◇ **Mode 3: accessible, green LED on and green LED flashes after a good read and then green LED keeps on**
- ◇ **Mode 4: Maintenance, red LED on and green LED flashes after a good read and then red LED keeps on**
- ◇ **Mode 5: Maintenance, blue LED on and green LED flashes after a good read and then blue LED keeps on**



IECGI0
Mode 0



IECGI1
Mode 1



IECGI2
Mode 2



IECGI3
Mode 3



IECGI4
Mode 4



IECGI5
Mode 5



@SETUPE0
**** Exit Setup**



@SETUPE1
Enter Setup



@SETUPE0
**** Exit Setup**



@SETUPE1
Enter Setup

Power On Beep

The scanner can be programmed to beep when it is powered on. Scan the **Off** barcode if you do not want a power on beep.



@PWBENA1
On



@PWBENA0
Off

Good Read Beep

Scanning the **Off** barcode can turn off the beep that indicates successful decode; scanning the **On** barcode can turn it back on.



@GRBENA1
On



@GRBENA0
Off



@SETUPE0
**** Exit Setup**



@SETUPE1
Enter Setup

Good Read Beep Duration

This parameter sets the length of the beep the scanner emits on a good read. It is programmable in 1ms increments from 20ms to 300ms.



@GRBDUR40
Short (40ms)



@GRBDUR80
Medium (80ms)



@GRBDUR120
Long (120ms)



@GRBDUR
Custom (20 – 300ms)



Set the Good Read Beep duration to 200ms:

1. Scan the **Enter Setup** barcode.
2. Scan the **Custom** barcode.
3. Scan the numeric barcodes “2”, “0” and “0” from the “Digit Barcodes” section in Appendix.
4. Scan the **Save** barcode from the “Save/Cancel Barcodes” section in Appendix.
5. Scan the **Exit Setup** barcode.



@SETUPE0
**** Exit Setup**



@SETUPE1
Enter Setup

Good Read Beep Frequency

This parameter is programmable in 1Hz increments from 20Hz to 20,000Hz.



@GRBFRQ800
Extra Low (800Hz)



@GRBFRQ1600
Low (1600Hz)



@GRBFRQ2730
Medium (2730Hz)



@GRBFRQ4200
High (4200Hz)



@GRBFRQ
Custom (20 - 20,000Hz)



Set the Good Read Beep frequency to 2,000Hz:

1. Scan the **Enter Setup** barcode.
2. Scan the **Custom** barcode.
3. Scan the numeric barcodes “2”, “0”, “0” and “0” from the “Digit Barcodes” section in Appendix.
4. Scan the **Save** barcode from the “Save/Cancel Barcodes” section in Appendix.
5. Scan the **Exit Setup** barcode.



@SETUPE0
**** Exit Setup**



@SETUPE1
Enter Setup

Good Read Beep Volume

There are 20 volume levels to choose from. The bigger the value, the louder the Good Read Beep.



@GRBVLL20
Loud



@GRBVLL12
Medium



@GRBVLL5
Low



@GRBVLL
Custom Volume (Level 1-20)



Set the Good Read Beep volume to Level 8:

1. Scan the **Enter Setup** barcode.
2. Scan the **Custom Volume** barcode.
3. Scan the numeric barcode “8” from the “Digit Barcodes” section in Appendix.
4. Scan the **Save** barcode from the “Save/Cancel Barcodes” section in Appendix.
5. Scan the **Exit Setup** barcode.

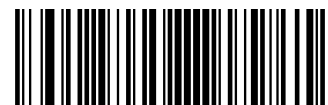

@SETUPE0
**** Exit Setup**



@SETUPE1
Enter Setup

NFC Function

When the NFC function is enabled, the scanner (NFC version) will read NFC cards.



@NFCENA0
Disable NFC Function



@NFCENA1
Enable NFC Function

NFC Card Searching Duration

This parameter is programmable.



@NFCDUR
NFC Card Searching Duration



Set the NFC card searching duration to 1,000ms:

1. Scan the **Enter Setup** barcode.
2. Scan the **NFC Card Searching Duration** barcode.
3. Scan the numeric barcodes “1”, “0”, “0” and “0” from the “Digit Barcodes” section in Appendix.
4. Scan the **Save** barcode from the “Save/Cancel Barcodes” section in Appendix.
5. Scan the **Exit** Setup barcode.



@SETUPE0
**** Exit Setup**



@SETUPE1
Enter Setup

NFC Mode

NFCMOD0: The scanner is in search for cards. When the card is read, card No. will be output. Other instructions are not allowed during the period.

NFCMOD1: Operations such as request for card, conflict prevention and card selection are controlled by the host

NFCMOD2: The scanner is in search for cards. When the card is read, card No. will be output. Other instructions are allowed.

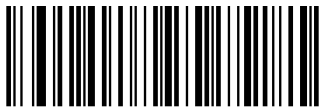

@NFCMOD0
Mode 0



@NFCMOD1
Mode 1

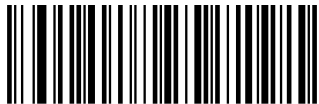

@NFCMOD2
Mode 2



@SETUPE0
**** Exit Setup**



@SETUPE1

Enter Setup

NFC Card Type Available for the FM3280

| Protocol Standard | Tag Type | Card Type | Result |
|------------------------|------------|---------------------------|--------|
| ISO 14443A | Type 1 Tag | Topaz 512 | Pass |
| ISO 14443A | Type 2 Tag | Mifare Ultralight NTAG216 | Pass |
| ISO 14443A | Type 2 Tag | Mifare Ultralight-C | Pass |
| ISO 14443A | Type 2 Tag | Mifare Ultralight AES | Pass |
| ISO 14443A | Type 2 Tag | Mifare Ultralight EV 1 | Pass |
| ISO 14443A | Type 2 Tag | NTAG215 | Pass |
| ISO 14443A | Type 2 Tag | Mifare UL | Pass |
| ISO 14443A | Type 2 Tag | NTAG213 | Pass |
| ISO 14443A | Type 2 Tag | NTAG203 | Pass |
| ISO 14443A | Type 2 Tag | NTAG200 | Pass |
| ISO 14443A | Type 2 Tag | NTAG 424 DNA | Pass |
| ISO 14443A | Type 2 Tag | NTAG 213/215/216 | Pass |
| ISO 18000-3M1 | Type 2 Tag | ICODE SLIX 2 | Pass |
| ISO 18000-3M1 | Type 2 Tag | ICODE SLIX | Pass |
| ISO 18000-3M1 | Type 2 Tag | ICODE SLIX-L | Pass |
| ISO 18000-3M1 | Type 2 Tag | ICODE SLIX-S | Pass |
| ISO 7816-3 | Type 2 Tag | Felica | Pass |
| ISO 14443A | Type 4 Tag | Mifare Desfire D22 | Pass |
| ISO 14443A | Type 4 Tag | Mifare Desfire EV1 | Pass |
| ISO 14443A | Type 4 Tag | Mifare Desfire EV2 | Pass |
| ISO 14443A | Type 4 Tag | Mifare Desfire EV3 | Pass |
| ISO 14443A | Type 4 Tag | Mifare Desfire Light | Pass |
| ISO 14443A | Type 4 Tag | Mifare Desfire D42 | Pass |
| ISO 14443A | Type 4 Tag | Mifare Desfire D82 | Pass |
| ISO 14443A | Type 4 Tag | Mifare Classic EV1 | Pass |
| ISO 14443A ISO 7816 | Type 4 Tag | Mifare Plus EV2 | Pass |
| ISO 14443A ISO 7816 | Type 4 Tag | Mifare Plus X | Pass |
| ISO 14443A | Type 4 Tag | Mifare Plus SE | Pass |



@SETUPE0

** Exit Setup



@SETUPE1
Enter Setup

| | | | |
|------------|------------|--------------------|------|
| ISO 14443A | Type 7 Tag | Mifare Plus 4k | Pass |
| ISO 14443A | Type 7 Tag | Mifare Plus 2k | Pass |
| ISO 14443A | Type 7 Tag | Mifare 1K | Pass |
| ISO 14443A | Type 7 Tag | NXP-S70 EV1 | Pass |
| ISO 14443A | Type 7 Tag | Mifare Classic S50 | Pass |
| ISO 14443A | Type 7 Tag | Mifare Classic S70 | Pass |

Timeout between Decodes (Same NFC Card)

Timeout between Decodes (Same NFC Card) can avoid undesired rereading of same NFC card in a given period of time.

To enable/disable the Timeout between Decodes (Same NFC Card), scan the appropriate barcode below.

Enable Timeout between Decodes (Same NFC Card): Do not allow the scanner to re-read same NFC card before the timeout between decodes (same NFC card) expires.

Disable Timeout between Decodes (Same NFC Card): Allow the scanner to re-read same NFC card.



Enable Timeout between Decodes (Same NFC Card)



Disable Timeout between Decodes (Same NFC Card)

The following parameter sets the timeout between decodes for same NFC card. It is programmable in 1ms increments from 1ms to 3,600,000ms.



Timeout between Decodes (Same NFC Card)



@SETUPE0
** Exit Setup



@SETUPE1

Enter Setup



Set the timeout between decodes (same NFC card) to 1,000ms:

1. Scan the **Enter Setup** barcode.
2. Scan the **Timeout between Decodes (Same NFC Card)** barcode.
3. Scan the numeric barcodes “1”, “0”, “0” and “0” from the “Digit Barcodes” section in Appendix.
4. Scan the **Save** barcode from the “Save/Cancel Barcodes” section in Appendix.
5. Scan the **Exit Setup** barcode.



@SETUPE0

**** Exit Setup**



@SETUPE1

Enter Setup



@SETUPE0

**** Exit Setup**



@SETUPE1
Enter Setup

Chapter 9 Symbologies

Introduction

Every symbology (barcode type) has its own unique attributes. This chapter provides programming barcodes for configuring the scanner so that it can identify various symbologies. It is recommended to disable those that are rarely used to increase the efficiency of the scanner.

Global Settings

Enable/Disable All Symbologies

If the **Disable All Symbologies** feature is enabled, the scanner will not be able to read any non-programming barcodes except the programming barcodes.



@ALLENA1
Enable All Symbologies



@ALLENA0
Disable All Symbologies

Enable/Disable 1D Symbologies



@ALL1DC1
Enable 1D Symbologies



@ALL1DC0
Disable 1D Symbologies



@SETUPE0
** Exit Setup



@SETUPE1

Enter Setup

Enable/Disable 2D Symbologies



@ALL2DC1

Enable 2D Symbologies



@ALL2DC0

Disable 2D Symbologies

Enable/Disable Postal Symbologies



@ALLPST1

Enable All Postal Symbologies



@ALLPST0

Disable All Postal Symbologies



@SETUPE0

**** Exit Setup**



@SETUPE1
Enter Setup

1D Twin Code

1D twin code is two 1D barcodes of a symbology or of different symbologies paralleled vertically. Both barcodes must have similar specifications and be placed closely together.

There are 3 options for reading 1D twin code:

- ◇ **Single 1D Code Only:** Read either 1D code.
- ◇ **Twin 1D Code Only:** Read both 1D codes. Transmission sequence: upper 1D code followed by lower 1D code.
- ◇ **Both Single & Twin:** Read both 1D codes. If successful, transmit as twin 1D code only. Otherwise, try single 1D code only.

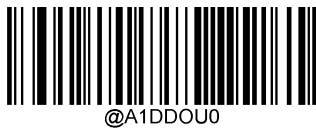

@A1DDOU0
Single 1D Code Only



@A1DDOU2
Twin 1D Code Only

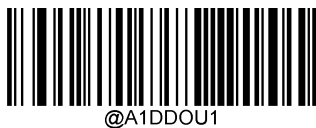

@A1DDOU1
Both Single & Twin



@SETUPE0
**** Exit Setup**



@SETUPE1
Enter Setup

Surround GS1 Application Identifiers (AI's) with Parentheses

When **Surround GS1 AI's with Parentheses** is selected, each application identifier (AI) contained in scanned data will be enclosed in parentheses in the output message.



@GS1AIP0

Do Not Surround GS1 AI's with Parentheses



@GS1AIP1

Surround GS1 AI's with Parentheses

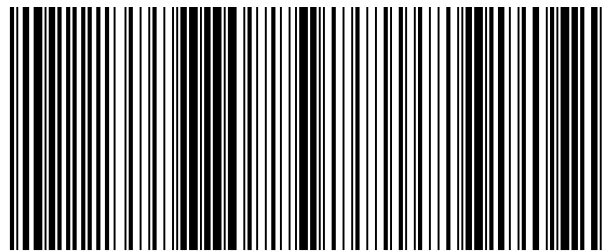

(01) 0 0614141 99999 6 (10) 10ABCEDF123456

If **Surround GS1 AI's with Parentheses** is selected, the barcode above is output as (01)00614141999996(10)10ABCEDF123456.

If **Do Not Surround GS1 AI's with Parentheses** is selected, the barcode above is output as 01006141419999961010ABCEDF123456.

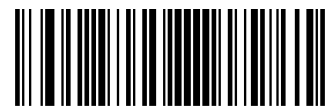

@SETUPE0
** Exit Setup



@SETUPE1
Enter Setup

Security Level

This parameter sets decoding times that is required to correctly read the barcode. The higher the security level, the lower the decoding error rate, but the slower the speed. This setting is only available for 1D barcodes.

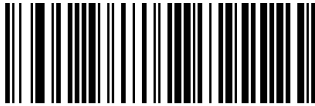

@SAFLVL0
Security Level 1

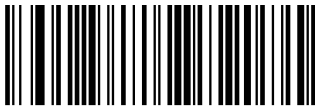

@SAFLVL2
Security Level 3



@SAFLVL1
Security Level 2



@SAFLVL3
Security Level 4

Enable Security Level



@SAF0021
Enable Security Level for Code 128



@SAF0031
Enable Security Level for GS1-128
(UCC/EAN-128)



@SETUPE0
** Exit Setup



@SETUPE1

Enter Setup



@SAF0041

Enable Security Level for EAN-8



@SAF0051

Enable Security Level for EAN-13



@SAF0061

Enable Security Level for UPC-E



@SAF0071

Enable Security Level for UPC-A



@SAF0081

Enable Security Level for Interleaved 2 of 5



@SAF0091

Enable Security Level for ITF-14



@SAF0101

Enable Security Level for ITF-6



@SAF0111

Enable Security Level for Matrix 2 of 5



@SAF0131

Enable Security Level for Code 39



@SETUPE0

**** Exit Setup**



@SETUPE1
Enter Setup



@SAF0151
Enable Security Level for Codabar



@SAF0171
Enable Security Level for Code 93



@SAF0201
Enable Security Level for AIM 128



@SAF0231
Enable Security Level for ISSN



@SAF0241
Enable Security Level for ISBN



@SAF0251
Enable Security Level for Industrial 25



@SAF0261
Enable Security Level for Standard 25



@SAF0271
Enable Security Level for Plessey



@SETUPE0
**** Exit Setup**



@SETUPE1

Enter Setup



@SAF0281

Enable Security Level for Code 11



@SAF0291

Enable Security Level for MSI Plessey



@SAF0311

**Enable Security Level for GS1 Databar
(RSS)**

Disable Security Level



@SAF0020

Disable Security Level for Code 128



@SAF0030

**Disable Security Level for GS1-128
(UCC/EAN-128)**

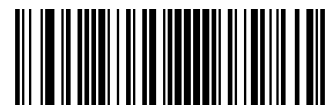

@SETUPE0

**** Exit Setup**



@SETUPE1

Enter Setup



@SAF0040

Disable Security Level for EAN-8



@SAF0050

Disable Security Level for EAN-13



@SAF0060

Disable Security Level for UPC-E



@SAF0070

Disable Security Level for UPC-A



@SAF0080

Disable Security Level for Interleaved 2 of 5



@SAF0090

Disable Security Level for ITF-14



@SAF0100

Disable Security Level for ITF-6



@SAF0110

Disable Security Level for Matrix 2 of 5



@SAF0130

Disable Security Level for Code 39



@SETUPE0

**** Exit Setup**



@SETUPE1

Enter Setup



@SAF0150

Disable Security Level for Codabar



@SAF0170

Disable Security Level for Code 93



@SAF0200

Disable Security Level for AIM 128



@SAF0230

Disable Security Level for ISSN



@SAF0240

Disable Security Level for ISBN



@SAF0250

Disable Security Level for Industrial 25



@SAF0260

Disable Security Level for Standard 25



@SAF0270

Disable Security Level for Plessey



@SETUPE0

**** Exit Setup**



@SETUPE1

Enter Setup



@SAF0280

Disable Security Level for Code 11



@SAF0290

Disable Security Level for MSI Plessy



@SAF0310

**Disable Security Level for GS1 Databar
(RSS)**



@SETUPE0

**** Exit Setup**



@SETUPE1
Enter Setup

Code 128

Restore Factory Defaults



@128DEF

Restore the Factory Defaults of Code 128

Enable/Disable Code 128



@128ENA1

Enable Code 128



@128ENA0

Disable Code 128



If the scanner fails to identify Code 128 barcodes, you may first try this solution by scanning the **Enter Setup** barcode and then **Enable Code 128** barcode.



@SETUPE0
**** Exit Setup**



@SETUPE1
Enter Setup

Set Length Range for Code 128

The scanner can be configured to only decode Code 128 barcodes with lengths that fall between (inclusive) the minimum and maximum lengths. To accomplish it, you need to set the minimum and maximum lengths.



@128MIN
Set the Minimum Length



@128MAX
Set the Maximum Length



If minimum length is set to be greater than maximum length, the scanner only decodes Code 128 barcodes with either the minimum or maximum length. If minimum length is same as maximum length, only Code 128 barcodes with that length are to be decoded.



Set the scanner to decode Code 128 barcodes containing between 8 and 12 characters:

1. Scan the **Enter Setup** barcode.
2. Scan the **Set the Minimum Length** barcode.
3. Scan the numeric barcode “8” from the “Digit Barcodes” section in Appendix.
4. Scan the **Save** barcode from the “Save/Cancel Barcodes” section in Appendix.
5. Scan the **Set the Maximum Length** barcode.
6. Scan the numeric barcodes “1” and “2” from the “Digit Barcodes” section in Appendix.
7. Scan the **Save** barcode from the “Save/Cancel Barcodes” section in Appendix.
8. Scan the **Exit Setup** barcode.



@SETUPE0
**** Exit Setup**



@SETUPE1
Enter Setup

EAN-8

Restore Factory Defaults



@EA8DEF

Restore the Factory Defaults of EAN-8

Enable/Disable EAN-8



@EA8ENA1

Enable EAN-8



@EA8ENA0

Disable EAN-8



If the scanner fails to identify EAN-8 barcodes, you may first try this solution by scanning the **Enter Setup** barcode and then **Enable EAN-8** barcode.

Transmit Check Character

EAN-8 is 8 digits in length with the last one as its check character used to verify the integrity of the data.



@EA8CHK2

Transmit EAN-8 Check Character



@EA8CHK1

Do Not Transmit EAN-8 Check Character



@SETUPE0

** Exit Setup



@SETUPE1
Enter Setup

2-Digit Add-On Code

An EAN-8 barcode can be augmented with a two-digit add-on code to form a new one. In the example below, the part surrounded by blue dotted line is an EAN-8 barcode while the part circled by red dotted line is a two-digit add-on code.



@EA8AD20
Disable 2-Digit Add-On Code



@EA8AD21
Enable 2-Digit Add-On Code



Disable 2-Digit Add-On Code: The scanner decodes EAN-8 and ignores the add-on code when presented with an EAN-8 plus 2-digit add-on barcode. It can also decode EAN-8 barcodes without 2-digit add-on codes.

Enable 2-Digit Add-On Code: The scanner decodes a mix of EAN-8 barcodes with and without 2-digit add-on codes.



@SETUPE0
** Exit Setup



@SETUPE1

Enter Setup

5-Digit Add-On Code

An EAN-8 barcode can be augmented with a five-digit add-on code to form a new one. In the example below, the part surrounded by blue dotted line is an EAN-8 barcode while the part circled by red dotted line is a five-digit add-on code.



@EA8AD50

Disable 5-Digit Add-On Code



@EA8AD51

Enable 5-Digit Add-On Code



Disable 5-Digit Add-On Code: The scanner decodes EAN-8 and ignores the add-on code when presented with an EAN-8 plus 5-digit add-on barcode. It can also decode EAN-8 barcodes without 5-digit add-on codes.

Enable 5-Digit Add-On Code: The scanner decodes a mix of EAN-8 barcodes with and without 5-digit add-on codes.

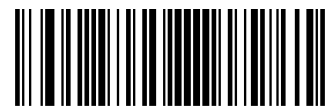

@SETUPE0

** Exit Setup



@SETUPE1
Enter Setup

Add-On Code Required

When **EAN-8 Add-On Code Required** is selected, the scanner will only read EAN-8 barcodes that contain add-on codes.



@EA8REQ0
EAN-8 Add-On Code Not Required



@EA8REQ1
EAN-8 Add-On Code Required

Convert EAN-8 to EAN-13

Convert EAN-8 to EAN-13: Convert EAN-8 decoded data to EAN-13 format before transmission. After conversion, the data follows EAN-13 format and is affected by EAN-13 programming selections (e.g., Check Character).

Do Not Convert EAN-8 to EAN-13: EAN-8 decoded data is transmitted as EAN-8 data, without conversion.



@EA8EXP0
Do Not Convert EAN-8 to EAN-13



@EA8EXP1
Convert EAN-8 to EAN-13



@SETUPE0
**** Exit Setup**



@SETUPE1
Enter Setup

EAN-13

Restore Factory Defaults



@E13DEF

Restore the Factory Defaults of EAN-13

Enable/Disable EAN-13



@E13ENA1

Enable EAN-13



@E13ENA0

Disable EAN-13



If the scanner fails to identify EAN-13 barcodes, you may first try this solution by scanning the **Enter Setup** barcode and then **Enable EAN-13** barcode.

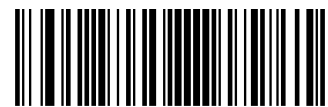

@SETUPE0
**** Exit Setup**



@SETUPE1
Enter Setup

Transmit Check Character



@E13CHK2

Transmit EAN-13 Check Character



@E13CHK1

Do Not Transmit EAN-13 Check Character

2-Digit Add-On Code

An EAN-13 barcode can be augmented with a two-digit add-on code to form a new one. In the example below, the part surrounded by blue dotted line is an EAN-13 barcode while the part circled by red dotted line is a two-digit add-on code.



@E13AD20

Disable 2-Digit Add-On Code



@E13AD21

Enable 2-Digit Add-On Code



Disable 2-Digit Add-On Code: The scanner decodes EAN-13 and ignores the add-on code when presented with an EAN-13 plus 2-digit add-on barcode. It can also decode EAN-13 barcodes without 2-digit add-on codes.

Enable 2-Digit Add-On Code: The scanner decodes a mix of EAN-13 barcodes with and without 2-digit add-on codes.



@SETUPE0

** Exit Setup



@SETUPE1
Enter Setup

5-Digit Add-On Code

An EAN-13 barcode can be augmented with a five-digit add-on code to form a new one. In the example below, the part surrounded by blue dotted line is an EAN-13 barcode while the part circled by red dotted line is a five-digit add-on code.



Disable 5-Digit Add-On Code



Enable 5-Digit Add-On Code



Disable 5-Digit Add-On Code: The scanner decodes EAN-13 and ignores the add-on code when presented with an EAN-13 plus 5-digit add-on barcode. It can also decode EAN-13 barcodes without 5-digit add-on codes.

Enable 5-Digit Add-On Code: The scanner decodes a mix of EAN-13 barcodes with and without 5-digit add-on codes.

Add-On Code Required

When **EAN-13 Add-On Code Required** is selected, the scanner will only read EAN-13 barcodes that contain add-on codes.



EAN-13 Add-On Code Not Required



EAN-13 Add-On Code Required



@SETUPE0
** Exit Setup



@SETUPE1
Enter Setup

EAN-13 Beginning with 290 Add-On Code Required

This setting programs the scanner to require an add-on code (2-digit or 5-digit) on EAN-13 barcodes that begin with “290”. The following settings can be programmed:

Require Add-On Code: All EAN-13 barcodes that begin with “290” must have a 2-digit or 5-digit add-on code. The EAN-13 barcode with the add-on code is then transmitted. If the required add-on code is not found, the EAN-13 barcode is discarded.

Do Not Require Add-On Code: If you have selected **Require Add-On Code**, and you want to disable this feature, scan **Do Not Require Add-On Code**. EAN-13 barcodes are handled, depending on your selection for the “Add-On Code Required” feature.



@E132900

Do Not Require Add-On Code



@E132901

Require Add-On Code

EAN-13 Beginning with 378/379 Add-On Code Required

This setting programs the scanner to require an add-on code (2-digit or 5-digit) on EAN-13 barcodes that begin with a “378” or “379”. The following settings can be programmed:

Require Add-On Code: All EAN-13 barcodes that begin with a “378” or “379” must have a 2-digit or 5-digit add-on code. The EAN-13 barcode with the add-on code is then transmitted. If the required add-on code is not found, the EAN-13 barcode is discarded.

Do Not Require Add-On Code: If you have selected **Require Add-On Code**, and you want to disable this feature, scan **Do Not Require Add-On Code**. EAN-13 barcodes are handled, depending on your selection for the “Add-On Code Required” feature.



@E133780

Do Not Require Add-On Code



@E133781

Require Add-On Code



@SETUPE0
** Exit Setup



@SETUPE1
Enter Setup

EAN-13 Beginning with 414/419 Add-On Code Required

This setting programs the scanner to require an add-on code (2-digit or 5-digit) on EAN-13 barcodes that begin with a “414” or “419”. The following settings can be programmed:

Require Add-On Code: All EAN-13 barcodes that begin with a “414” or “419” must have a 2-digit or 5-digit add-on code. The EAN-13 barcode with the add-on code is then transmitted. If the required add-on code is not found, the EAN-13 barcode is discarded.

Do Not Require Add-On Code: If you have selected **Require Add-On Code**, and you want to disable this feature, scan **Do Not Require Add-On Code**. EAN-13 barcodes are handled, depending on your selection for the “Add-On Code Required” feature.



Do Not Require Add-On Code



Require Add-On Code

EAN-13 Beginning with 434/439 Add-On Code Required

This setting programs the scanner to require an add-on code (2-digit or 5-digit) on EAN-13 barcodes that begin with a “434” or “439”. The following settings can be programmed:

Require Add-On Code: All EAN-13 barcodes that begin with a “434” or “439” must have a 2-digit or 5-digit add-on code. The EAN-13 barcode with the add-on code is then transmitted. If the required add-on code is not found, the EAN-13 barcode is discarded.

Do Not Require Add-On Code: If you have selected **Require Add-On Code**, and you want to disable this feature, scan **Do Not Require Add-On Code**. EAN-13 barcodes are handled, depending on your selection for the “Add-On Code Required” feature.



Do Not Require Add-On Code



Require Add-On Code



@SETUPE0
** Exit Setup



@SETUPE1
Enter Setup

EAN-13 Beginning with 977 Add-On Code Required

This setting programs the scanner to require an add-on code (2-digit or 5-digit) on EAN-13 barcodes that begin with “977”. The following settings can be programmed:

Require Add-On Code: All EAN-13 barcodes that begin with “977” must have a 2-digit or 5-digit add-on code. The EAN-13 barcode with the add-on code is then transmitted. If the required add-on code is not found, the EAN-13 barcode is discarded.

Do Not Require Add-On Code: If you have selected **Require Add-On Code**, and you want to disable this feature, scan **Do Not Require Add-On Code**. EAN-13 barcodes are handled, depending on your selection for the “Add-On Code Required” feature.



@E139770

Do Not Require Add-On Code



@E139771

Require Add-On Code

EAN-13 Beginning with 978 Add-On Code Required

This setting programs the scanner to require an add-on code (2-digit or 5-digit) on EAN-13 barcodes that begin with “978”. The following settings can be programmed:

Require Add-On Code: All EAN-13 barcodes that begin with “978” must have a 2-digit or 5-digit add-on code. The EAN-13 barcode with the add-on code is then transmitted. If the required add-on code is not found, the EAN-13 barcode is discarded.

Do Not Require Add-On Code: If you have selected **Require Add-On Code**, and you want to disable this feature, scan **Do Not Require Add-On Code**. EAN-13 barcodes are handled, depending on your selection for the “Add-On Code Required” feature.



@E139780

Do Not Require Add-On Code



@E139781

Require Add-On Code



@SETUPE0
** Exit Setup



@SETUPE1
Enter Setup

EAN-13 Beginning with 979 Add-On Code Required

This setting programs the scanner to require an add-on code (2-digit or 5-digit) on EAN-13 barcodes that begin with “979”. The following settings can be programmed:

Require Add-On Code: All EAN-13 barcodes that begin with “979” must have a 2-digit or 5-digit add-on code. The EAN-13 barcode with the add-on code is then transmitted. If the required add-on code is not found, the EAN-13 barcode is discarded.

Do Not Require Add-On Code: If you have selected **Require Add-On Code**, and you want to disable this feature, scan **Do Not Require Add-On Code**. EAN-13 barcodes are handled, depending on your selection for the “Add-On Code Required” feature.



@E139790

Do Not Require Add-On Code



@E139791

Require Add-On Code



@SETUPE0
** Exit Setup



@SETUPE1

Enter Setup

JAN Code for Magazines

Japanese Article Number (JAN) is a barcode standard compatible with the EAN. JAN barcodes for magazines are EAN-13 barcodes starting with a "491" and containing a 5-digit add-on code. Scan the appropriate barcode below to enable or disable JAN barcodes for magazines.



@E13MEN0

Disable JAN Code for Magazines



@E13MEN1

Enable JAN Code for Magazines



@SETUPE0

**** Exit Setup**



@SETUPE1
Enter Setup

UPC-E

Restore Factory Defaults



@UPEDEF
Restore the Factory Defaults of UPC-E

Enable/Disable UPC-E

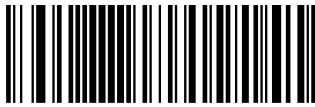

@UPEEN01
Enable UPC-E0



@UPEEN00
Disable UPC-E0



@UPEEN11
Enable UPC-E1



@UPEEN10
Disable UPC-E1



If the scanner fails to identify UPC-E0/UPC-E1 barcodes, you may first try this solution by scanning the **Enter Setup** barcode and then **Enable UPC-E0/UPC-E1** barcode.

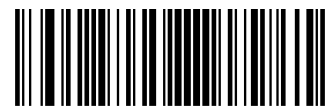

@SETUPE0
**** Exit Setup**



@SETUPE1
Enter Setup

Transmit Check Character

UPC-E is 8 digits in length with the last one as its check character used to verify the integrity of the data.



@UPECHK2
Transmit UPC-E Check Character



@UPECHK1
Do Not Transmit UPC-E Check Character

2-Digit Add-On Code

A UPC-E barcode can be augmented with a two-digit add-on code to form a new one. In the example below, the part surrounded by blue dotted line is a UPC-E barcode while the part circled by red dotted line is a two-digit add-on code.



@UPEAD20
Disable 2-Digit Add-On Code



@UPEAD21
Enable 2-Digit Add-On Code



Disable 2-Digit Add-On Code: The scanner decodes UPC-E and ignores the add-on code when presented with a UPC-E plus 2-digit add-on barcode. It can also decode UPC-E barcodes without 2-digit add-on codes.

Enable 2-Digit Add-On Code: The scanner decodes a mix of UPC-E barcodes with and without 2-digit add-on codes.



@SETUPE0
** Exit Setup



@SETUPE1
Enter Setup

5-Digit Add-On Code

A UPC-E barcode can be augmented with a five-digit add-on code to form a new one. In the example below, the part surrounded by blue dotted line is a UPC-E barcode while the part circled by red dotted line is a five-digit add-on code.



@UPEAD50
Disable 5-Digit Add-On Code



@UPEAD51
Enable 5-Digit Add-On Code



Disable 5-Digit Add-On Code: The scanner decodes UPC-E and ignores the add-on code when presented with a UPC-E plus 5-digit add-on barcode. It can also decode UPC-E barcodes without 5-digit add-on codes.

Enable 5-Digit Add-On Code: The scanner decodes a mix of UPC-E barcodes with and without 5-digit add-on codes.

Add-On Code Required

When **UPC-E Add-On Code Required** is selected, the scanner will only read UPC-E barcodes that contain add-on codes.



@UPEREQ0
UPC-E Add-On Code Not Required



@UPEREQ1
UPC-E Add-On Code Required



@SETUPE0
** Exit Setup



@SETUPE1
Enter Setup

Transmit Preamble Character

Preamble characters (Country Code and System Character) can be transmitted as part of a UPC-E barcode. Select one of the following options for transmitting UPC-E preamble to the host device: transmit system character only, transmit system character and country code ("0" for USA), or transmit no preamble.

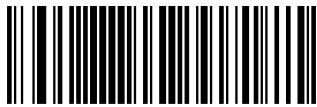

@UPEPRE1
System Character



@UPEPRE0
No Preamble



@UPEPRE2
System Character & Country Code

Extend UPC-E as UPC-A

Extend UPC-E as UPC-A: Extend UPC-E decoded data to UPC-A format before transmission, and UPC-E decoded data is still transmitted as UPC-E data.

Do Not Extend UPC-E as UPC-A: UPC-E decoded data is transmitted as UPC-E data.

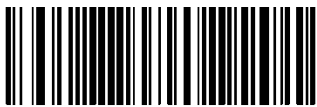

@UPEEXP0
Do Not Extend UPC-E as UPC-A



@UPEEXP2
Extend UPC-E as UPC-A



@SETUPE0
** Exit Setup



@SETUPE1
Enter Setup

UPC-A

Restore Factory Defaults



@UPADEF

Restore the Factory Defaults of UPC-A

Enable/Disable UPC-A



@UPAENA1

Enable UPC-A



@UPAENA0

Disable UPC-A



If the scanner fails to identify UPC-A barcodes, you may first try this solution by scanning the **Enter Setup** barcode and then **Enable UPC-A** barcode.

Transmit Check Character

UPC-A is 13 digits in length with the last one as its check character used to verify the integrity of the data.



@UPACHK2

Transmit UPC-A Check Character



@UPACHK1

Do Not Transmit UPC-A Check Character

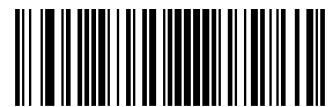

@SETUPE0
**** Exit Setup**



@SETUPE1
Enter Setup

2-Digit Add-On Code

A UPC-A barcode can be augmented with a two-digit add-on code to form a new one. In the example below, the part surrounded by blue dotted line is a UPC-A barcode while the part circled by red dotted line is a two-digit add-on code.



@UPAAD20
Disable 2-Digit Add-On Code



@UPAAD21
Enable 2-Digit Add-On Code



Disable 2-Digit Add-On Code: The scanner decodes UPC-A and ignores the add-on code when presented with a UPC-A plus 2-digit add-on barcode. It can also decode UPC-A barcodes without 2-digit add-on codes.

Enable 2-Digit Add-On Code: The scanner decodes a mix of UPC-A barcodes with and without 2-digit add-on codes.



@SETUPE0
** Exit Setup



@SETUPE1

Enter Setup

5-Digit Add-On Code

A UPC-A barcode can be augmented with a five-digit add-on code to form a new one. In the example below, the part surrounded by blue dotted line is a UPC-A barcode while the part circled by red dotted line is a five-digit add-on code.



@UPAAD50

Disable 5-Digit Add-On Code



@UPAAD51

Enable 5-Digit Add-On Code



Disable 5-Digit Add-On Code: The scanner decodes UPC-A and ignores the add-on code when presented with a UPC-A plus 5-digit add-on barcode. It can also decode UPC-A barcodes without 5-digit add-on codes.

Enable 5-Digit Add-On Code: The scanner decodes a mix of UPC-A barcodes with and without 5-digit add-on codes.

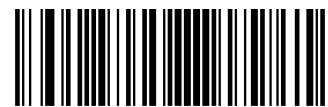

@SETUPE0

** Exit Setup



@SETUPE1
Enter Setup

Add-On Code Required

When **UPC-A Add-On Code Required** is selected, the scanner will only read UPC-A barcodes that contain add-on codes.



@UPAREQ0
UPC-A Add-On Code Not Required



@UPAREQ1
UPC-A Add-On Code Required

Transmit Preamble Character

Preamble characters (Country Code and System Character) can be transmitted as part of a UPC-A barcode. Select one of the following options for transmitting UPC-A preamble to the host device: transmit system character only, transmit system character and country code ("0" for USA), or transmit no preamble.



@UPAPRE0
No Preamble



@UPAPRE1
System Character



@UPAPRE2
System Character & Country Code



@SETUPE0
**** Exit Setup**



@SETUPE1
Enter Setup

Coupon

UPC-A/EAN-13 with Extended Coupon Code

The following three types of coupon code + extended coupon code are supported:

- ✧ UPC-A (starting with “5”) + GS1-128
- ✧ UPC-A (starting with “5”) + GS1 Databar
- ✧ EAN-13 (starting with “99”) + GS1-128

Use the appropriate barcode below to enable or disable UPC-A/EAN-13 with Extended Coupon Code. When left on the default setting (**Off**), the scanner treats Coupon Codes and Extended Coupon Codes as single bar codes.

If you scan the **Allow Concatenation** code, when the scanner sees the coupon code and the extended coupon code in a single scan, it transmits both as separate symbologies. Otherwise, it transmits the first coupon code it reads.

If you scan the **Require Concatenation** code, the scanner must see and read the coupon code and extended coupon code in a single read to transmit the data. No data is output unless both codes are read.



@CPNENA0
Off



@CPNENA1
Allow Concatenation



@CPNENA2
Require Concatenation



When using the UPC-A Coupon feature, please ensure that **System Character** or **System Character & Country Code** is selected for the “Transmit UPC-A Preamble Character” feature.



@SETUPE0
**** Exit Setup**



@SETUPE1
Enter Setup

Coupon GS1 Databar Output

If you scan coupons that have both UPC and GS1 Databar codes, you may wish to scan and output only the data from the GS1 Databar code. Scan the **GS1 Output On** barcode below to scan and output only the GS1 Databar code data.

When **GS1 Output Off** is selected, coupons that have both UPC and GS1 Databar codes are transmitted depending on your selection for the “UPC-A/EAN-13 with Extended Coupon Code” feature.



@CPNGS10
GS1 Output Off



@CPNGS11
GS1 Output On



When using the UPC-A Coupon feature, please ensure that **System Character** or **System Character & Country Code** is selected for the “Transmit UPC-A Preamble Character” feature.



@SETUPE0
** Exit Setup



@SETUPE1
Enter Setup

Interleaved 2 of 5

Restore Factory Defaults



@I25DEF

Restore the Factory Defaults of Interleaved 2 of 5

Enable/Disable Interleaved 2 of 5



@I25ENA1

Enable Interleaved 2 of 5



@I25ENA0

Disable Interleaved 2 of 5



If the scanner fails to identify Interleaved 2 of 5 barcodes, you may first try this solution by scanning the **Enter Setup** barcode and then **Enable Interleaved 2 of 5** barcode.



@SETUPE0
**** Exit Setup**



@SETUPE1
Enter Setup

Set Length Range for Interleaved 2 of 5

The scanner can be configured to only decode Interleaved 2 of 5 barcodes with lengths that fall between (inclusive) the minimum and maximum lengths. To accomplish it, you need to set the minimum and maximum lengths.



@I25MIN
Set the Minimum Length



@I25MAX
Set the Maximum Length



If minimum length is set to be greater than maximum length, the scanner only decodes Interleaved 2 of 5 barcodes with either the minimum or maximum length. If minimum length is same as maximum length, only Interleaved 2 of 5 barcodes with that length are to be decoded.



Set the scanner to decode Interleaved 2 of 5 barcodes containing between 8 and 12 characters:

1. Scan the **Enter Setup** barcode.
2. Scan the **Set the Minimum Length** barcode.
3. Scan the numeric barcode “8” from the “Digit Barcodes” section in Appendix.
4. Scan the **Save** barcode from the “Save/Cancel Barcodes” section in Appendix.
5. Scan the **Set the Maximum Length** barcode.
6. Scan the numeric barcodes “1” and “2” from the “Digit Barcodes” section in Appendix.
7. Scan the **Save** barcode from the “Save/Cancel Barcodes” section in Appendix.
8. Scan the **Exit Setup** barcode.



@SETUPE0
**** Exit Setup**



@SETUPE1
Enter Setup

Check Character Verification

A check character is optional for Interleaved 2 of 5 and can be added as the last character. It is a calculated value used to verify the integrity of the data.

- ✧ **Disable:** The scanner transmits Interleaved 2 of 5 barcodes as is.
- ✧ **Do Not Transmit Check Character After Verification:** The scanner checks the integrity of all Interleaved 2 of 5 barcodes to verify that the data complies with the check character algorithm. Barcodes passing the check will be transmitted except the last digit, whereas those failing it will not be transmitted.
- ✧ **Transmit Check Character After Verification:** The scanner checks the integrity of all Interleaved 2 of 5 barcodes to verify that the data complies with the check character algorithm. Barcodes passing the check will be transmitted, whereas those failing it will not be transmitted.

Since Interleaved 2 of 5 must always have an even number of digits, a zero may need to be added as the first digit when the check character is added. The check character is automatically generated when making Interleaved 2 of 5 barcodes.



@I25CHK0
Disable



@I25CHK1
Do Not Transmit Check Character After Verification



@I25CHK2
Transmit Check Character After Verification



If the **Do Not Transmit Check Character After Verification** option is enabled, Interleaved 2 of 5 barcodes with a length that is less than the configured minimum length after having the check character excluded will not be decoded. (For example, when the **Do Not Transmit Check Character After Verification** option is enabled and the minimum length is set to 4, Interleaved 2 of 5 barcodes with a total length of 4 characters including the check character cannot be read.)



@SETUPE0
** Exit Setup



@SETUPE1
Enter Setup

Febraban

Disable/Enable Febraban



@I25FBB0
Disable Febraban



@I25FBB1
Enable Febraban, Do Not Expand



@I25FBB2
Enable Febraban, Expand

Transmit Delay per Character

Transmit Delay per Character applies to both Expanded and Unexpanded Febraban. This feature is available only when USB HID Keyboard is enabled.



@FEBSN0
Disable Transmit Delay per Character



@FEBSN1
Enable Transmit Delay per Character



@SETUPE0
** Exit Setup



@SETUPE1
Enter Setup

You may select an appropriate delay value from the options below as per your actual needs.



@FEBSDT0
0ms



@FEBSDT5
5ms



@FEBSDT10
10ms



@FEBSDT15
15ms



@FEBSDT20
20ms



@FEBSDT25
25ms



@FEBSDT30
30ms



@FEBSDT35
35ms



@SETUPE0
**** Exit Setup**



@SETUPE1
Enter Setup



@FEBSDT40
40ms



@FEBSDT45
45ms

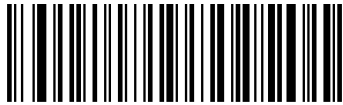

@FEBSDT50
50ms



@FEBSDT55
55ms



@FEBSDT60
60ms

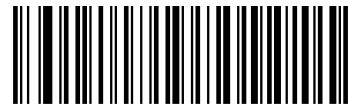

@FEBSDT65
65ms



@FEBSDT70
70ms



@FEBSDT75
75ms



@SETUPE0
**** Exit Setup**



@SETUPE1
Enter Setup

Transmit Delay per 12 Characters

Transmit Delay per 12 Characters applies to Expanded Febraban only. This feature is available only when USB HID Keyboard is enabled.



@FEBMEN0

Disable Transmit Delay per 12 Characters



@FEBMEN1

Enable Transmit Delay per 12 Characters

You may select an appropriate delay value from the options below as per your actual needs.



@FEBMDT0

0ms



@FEBMDT1

300ms

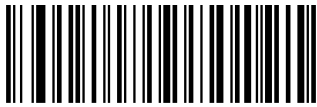

@FEBMDT2

400ms



@SETUPE0
**** Exit Setup**



@SETUPE1
Enter Setup



@FEBMDT3
500ms



@FEBMDT4
600ms



@FEBMDT5
700ms



@FEBMDT6
800ms



@FEBMDT7
900ms



@SETUPE0
**** Exit Setup**



@SETUPE1
Enter Setup

ITF-14

ITF-14 is a special kind of Interleaved 2 of 5 with a length of 14 characters and the last character as the check character.

ITF-14 priority principle: For the Interleaved 2 of 5 barcodes with a length of 14 characters and the last character as the check character, the ITF-14 configurations shall take precedence over the Interleaved 2 of 5 settings.

Restore Factory Defaults



@I14DEF

Restore the Factory Defaults of ITF-14

Enable/Disable ITF-14



@I14ENA0

Disable ITF-14



@I14ENA1

Enable ITF-14 But Do Not Transmit Check Character



@I14ENA2

Enable ITF-14 and Transmit Check Character



An example of the ITF-14 priority principle: when ITF-14 is enabled and Interleaved 2 of 5 is disabled, the scanner only decodes Interleaved 2 of 5 barcodes with a length of 14 characters and the last character as the check character.



@SETUPE0

**** Exit Setup**



@SETUPE1
Enter Setup

ITF-6

ITF-6 is a special kind of Interleaved 2 of 5 with a length of 6 characters and the last character as the check character.

ITF-6 priority principle: For the Interleaved 2 of 5 barcodes with a length of 6 characters and the last character as the check character, the ITF-6 configurations shall take precedence over the Interleaved 2 of 5 settings.

Restore Factory Defaults



@IT6DEF
Restore the Factory Defaults of ITF-6

Enable/Disable ITF-6



@IT6ENA0
Disable ITF-6



@IT6ENA1
Enable ITF-6 But Do Not Transmit Check Character



@IT6ENA2
Enable ITF-6 and Transmit Check Character



An example of the ITF-6 priority principle: when ITF-6 is enabled and Interleaved 2 of 5 is disabled, the scanner only decodes Interleaved 2 of 5 barcodes with a length of 6 characters and the last character as the check character.



@SETUPE0
** Exit Setup



@SETUPE1
Enter Setup

Matrix 2 of 5

Restore Factory Defaults



@M25DEF

Restore the Factory Defaults of Matrix 2 of 5

Enable/Disable Matrix 2 of 5



@M25ENA1

Enable Matrix 2 of 5



@M25ENA0

Disable Matrix 2 of 5



If the scanner fails to identify Matrix 2 of 5 barcodes, you may first try this solution by scanning the **Enter Setup** barcode and then **Enable Matrix 2 of 5** barcode.

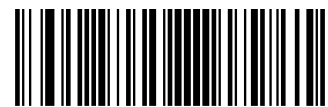

@SETUPE0
**** Exit Setup**



@SETUPE1
Enter Setup

Set Length Range for Matrix 2 of 5

The scanner can be configured to only decode Matrix 2 of 5 barcodes with lengths that fall between (inclusive) the minimum and maximum lengths. To accomplish it, you need to set the minimum and maximum lengths.



@M25MIN
Set the Minimum Length



@M25MAX
Set the Maximum Length



If minimum length is set to be greater than maximum length, the scanner only decodes Matrix 2 of 5 barcodes with either the minimum or maximum length. If minimum length is same as maximum length, only Matrix 2 of 5 barcodes with that length are to be decoded.



Set the scanner to decode Matrix 2 of 5 barcodes containing between 8 and 12 characters:

1. Scan the **Enter Setup** barcode.
2. Scan the **Set the Minimum Length** barcode.
3. Scan the numeric barcode “8” from the “Digit Barcodes” section in Appendix.
4. Scan the **Save** barcode from the “Save/Cancel Barcodes” section in Appendix.
5. Scan the **Set the Maximum Length** barcode.
6. Scan the numeric barcodes “1” and “2” from the “Digit Barcodes” section in Appendix.
7. Scan the **Save** barcode from the “Save/Cancel Barcodes” section in Appendix.
8. Scan the **Exit Setup** barcode.



@SETUPE0
**** Exit Setup**



@SETUPE1
Enter Setup

Check Character Verification

A check character is optional for Matrix 2 of 5 and can be added as the last character. It is a calculated value used to verify the integrity of the data.

- ✧ **Disable:** The scanner transmits Matrix 2 of 5 barcodes as is.
- ✧ **Do Not Transmit Check Character After Verification:** The scanner checks the integrity of all Matrix 2 of 5 barcodes to verify that the data complies with the check character algorithm. Barcodes passing the check will be transmitted except the last digit, whereas those failing it will not be transmitted.
- ✧ **Transmit Check Character After Verification:** The scanner checks the integrity of all Matrix 2 of 5 barcodes to verify that the data complies with the check character algorithm. Barcodes passing the check will be transmitted, whereas those failing it will not be transmitted.

Since Matrix 2 of 5 must always have an even number of digits, a zero may need to be added as the first digit when the check character is added. The check character is automatically generated when making Matrix 2 of 5 barcodes.



@M25CHK0
Disable



@M25CHK1
Do Not Transmit Check Character After Verification



@M25CHK2
Transmit Check Character After Verification



If the **Do Not Transmit Check Character After Verification** option is enabled, Matrix 2 of 5 barcodes with a length that is less than the configured minimum length after having the check character excluded will not be decoded. (For example, when the **Do Not Transmit Check Character After Verification** option is enabled and the minimum length is set to 4, Matrix 2 of 5 barcodes with a total length of 4 characters including the check character cannot be read.)



@SETUPE0
** Exit Setup



@SETUPE1
Enter Setup

Code 39

Restore Factory Defaults



@C39DEF
Restore the Factory Defaults of Code 39

Enable/Disable Code 39



@C39ENA1
Enable Code 39



@C39ENA0
Disable Code 39



If the scanner fails to identify Code 39 barcodes, you may first try this solution by scanning the **Enter Setup** barcode and then **Enable Code 39** barcode.



@SETUPE0
**** Exit Setup**



@SETUPE1
Enter Setup

Set Length Range for Code 39

The scanner can be configured to only decode Code 39 barcodes with lengths that fall between (inclusive) the minimum and maximum lengths. To accomplish it, you need to set the minimum and maximum lengths.



@C39MIN
Set the Minimum Length



@C39MAX
Set the Maximum Length



If minimum length is set to be greater than maximum length, the scanner only decodes Code 39 barcodes with either the minimum or maximum length. If minimum length is same as maximum length, only Code 39 barcodes with that length are to be decoded.



Set the scanner to decode Code 39 barcodes containing between 8 and 12 characters:

1. Scan the **Enter Setup** barcode.
2. Scan the **Set the Minimum Length** barcode.
3. Scan the numeric barcode “8” from the “Digit Barcodes” section in Appendix.
4. Scan the **Save** barcode from the “Save/Cancel Barcodes” section in Appendix.
5. Scan the **Set the Maximum Length** barcode.
6. Scan the numeric barcodes “1” and “2” from the “Digit Barcodes” section in Appendix.
7. Scan the **Save** barcode from the “Save/Cancel Barcodes” section in Appendix.
8. Scan the **Exit Setup** barcode.



@SETUPE0
**** Exit Setup**



@SETUPE1
Enter Setup

Check Character Verification

A check character is optional for Code 39 and can be added as the last character. It is a calculated value used to verify the integrity of the data.

- ✧ **Disable:** The scanner transmits Code 39 barcodes as is.
- ✧ **Do Not Transmit Check Character After Verification:** The scanner checks the integrity of all Code 39 barcodes to verify that the data complies with the check character algorithm. Barcodes passing the check will be transmitted except the last digit, whereas those failing it will not be transmitted.
- ✧ **Transmit Check Character After Verification:** The scanner checks the integrity of all Code 39 barcodes to verify that the data complies with the check character algorithm. Barcodes passing the check will be transmitted, whereas those failing it will not be transmitted.



@C39CHK0
Disable



Do Not Transmit Check Character After Verification



@C39CHK2

Transmit Check Character After Verification



If the **Do Not Transmit Check Character After Verification** option is enabled, Code 39 barcodes with a length that is less than the configured minimum length after having the check character excluded will not be decoded. (For example, when the **Do Not Transmit Check Character After Verification** option is enabled and the minimum length is set to 4, Code 39 barcodes with a total length of 4 characters including the check character cannot be read.)



@SETUPE0
** Exit Setup



@SETUPE1
Enter Setup

Transmit Start/Stop Character

Code 39 uses an asterisk (*) for both the start and the stop characters. You can choose whether or not to transmit the start/stop characters by scanning the appropriate barcode below.



@C39TSC0

Do Not Transmit Start/Stop Character



@C39TSC1

Transmit Start/Stop Character

Enable/Disable Code 39 Full ASCII

The scanner can be configured to identify all ASCII characters by scanning the appropriate barcode below.



@C39ASC0

Disable Code 39 Full ASCII



@C39ASC1

Enable Code 39 Full ASCII



@SETUPE0
**** Exit Setup**



@SETUPE1
Enter Setup

Enable/Disable Code 32 (Italian Pharma Code)

Code 32 is a variant of Code 39 used by the Italian pharmaceutical industry. Scan the appropriate bar code below to enable or disable Code 32. Code 39 must be enabled and Code 39 check character verification must be disabled for this parameter to function.



@C39E320
Disable Code 32



@C39E321
Enable Code 32

Code 32 Prefix

Scan the appropriate barcode below to enable or disable adding the prefix character "A" to all Code 32 barcodes. Code 32 must be enabled for this parameter to function.



@C39S320
Disable Code 32 Prefix



@C39S321
Enable Code 32 Prefix



@SETUPE0
**** Exit Setup**



@SETUPE1
Enter Setup

Transmit Code 32 Start/Stop Character

Code 32 must be enabled for this parameter to function.



@C39T320

Do Not Transmit Code 32 Start/Stop Character



@C39T321

Transmit Code 32 Start/Stop Character

Transmit Code 32 Check Character

Code 32 must be enabled for this parameter to function.



@C39C320

Do Not Transmit Code 32 Check Character



@C39C321

Transmit Code 32 Check Character

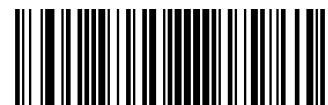

@SETUPE0
**** Exit Setup**



@SETUPE1
Enter Setup

Codabar

Restore Factory Defaults



@CBADEF
Restore the Factory Defaults of Codabar

Enable/Disable Codabar



@CBAENA1
Enable Codabar



@CBAENA0
Disable Codabar



If the scanner fails to identify Codabar barcodes, you may first try this solution by scanning the **Enter Setup** barcode and then **Enable Codabar** barcode.



@SETUPE0
**** Exit Setup**



@SETUPE1
Enter Setup

Set Length Range for Codabar

The scanner can be configured to only decode Codabar barcodes with lengths that fall between (inclusive) the minimum and maximum lengths. To accomplish it, you need to set the minimum and maximum lengths.



Set the Minimum Length



Set the Maximum Length



If minimum length is set to be greater than maximum length, the scanner only decodes Codabar barcodes with either the minimum or maximum length. If minimum length is same as maximum length, only Codabar barcodes with that length are to be decoded.



Set the scanner to decode Codabar barcodes containing between 8 and 12 characters:

1. Scan the **Enter Setup** barcode.
2. Scan the **Set the Minimum Length** barcode.
3. Scan the numeric barcode “8” from the “Digit Barcodes” section in Appendix.
4. Scan the **Save** barcode from the “Save/Cancel Barcodes” section in Appendix.
5. Scan the **Set the Maximum Length** barcode.
6. Scan the numeric barcodes “1” and “2” from the “Digit Barcodes” section in Appendix.
7. Scan the **Save** barcode from the “Save/Cancel Barcodes” section in Appendix.
8. Scan the **Exit Setup** barcode.



@SETUPE0
**** Exit Setup**



@SETUPE1
Enter Setup

Check Character Verification

A check character is optional for Codabar and can be added as the last character. It is a calculated value used to verify the integrity of the data.

- ✧ **Disable:** The scanner transmits Codabar barcodes as is.
- ✧ **Do Not Transmit Check Character After Verification:** The scanner checks the integrity of all Codabar barcodes to verify that the data complies with the check character algorithm. Barcodes passing the check will be transmitted except the last digit, whereas those failing it will not be transmitted.
- ✧ **Transmit Check Character After Verification:** The scanner checks the integrity of all Codabar barcodes to verify that the data complies with the check character algorithm. Barcodes passing the check will be transmitted, whereas those failing it will not be transmitted.

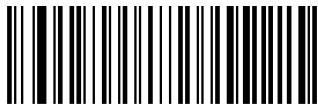

@CBACHK0
Disable



@CBACHK1
Do Not Transmit Check Character After Verification



@CBACHK2
Transmit Check Character After Verification



If the **Do Not Transmit Check Character After Verification** option is enabled, Codabar barcodes with a length that is less than the configured minimum length after having the check character excluded will not be decoded. (For example, when the **Do Not Transmit Check Character After Verification** option is enabled and the minimum length is set to 4, Codabar barcodes with a total length of 4 characters including the check character cannot be read.)



@SETUPE0
** Exit Setup



@SETUPE1

Enter Setup

Start/Stop Character

You can set the start/stop characters and choose whether or not to transmit the start/stop characters by scanning the appropriate barcode below.



@CBATSC0

Do Not Transmit Start/Stop Character



@CBATSC1

Transmit Start/Stop Character



@CBASCF0

ABCD/ABCD as the Start/Stop Character



@CBASCF1

ABCD/TN*E as the Start/Stop Character



@CBASCF2

abcd/abcd as the Start/Stop Character



@CBASCF3

abcd/tn*e as the Start/Stop Character



@SETUPE0

**** Exit Setup**



@SETUPE1
Enter Setup

Code 93

Restore Factory Defaults



@C93DEF
Restore the Factory Defaults of Code 93

Enable/Disable Code 93



@C93ENA1
Enable Code 93



@C93ENA0
Disable Code 93



If the scanner fails to identify Code 93 barcodes, you may first try this solution by scanning the **Enter Setup** barcode and then **Enable Code 93** barcode.



@SETUPE0
**** Exit Setup**



@SETUPE1
Enter Setup

Set Length Range for Code 93

The scanner can be configured to only decode Code 93 barcodes with lengths that fall between (inclusive) the minimum and maximum lengths. To accomplish it, you need to set the minimum and maximum lengths.



@C93MIN
Set the Minimum Length



@C93MAX
Set the Maximum Length



If minimum length is set to be greater than maximum length, the scanner only decodes Code 93 barcodes with either the minimum or maximum length. If minimum length is same as maximum length, only Code 93 barcodes with that length are to be decoded.



Set the scanner to decode Code 93 barcodes containing between 8 and 12 characters:

1. Scan the **Enter Setup** barcode.
2. Scan the **Set the Minimum Length** barcode.
3. Scan the numeric barcode “8” from the “Digit Barcodes” section in Appendix.
4. Scan the **Save** barcode from the “Save/Cancel Barcodes” section in Appendix.
5. Scan the **Set the Maximum Length** barcode.
6. Scan the numeric barcodes “1” and “2” from the “Digit Barcodes” section in Appendix.
7. Scan the **Save** barcode from the “Save/Cancel Barcodes” section in Appendix.
8. Scan the **Exit Setup** barcode.



@SETUPE0
**** Exit Setup**



@SETUPE1
Enter Setup

China Post 25

Restore Factory Defaults



@CHPDEF
Restore the Factory Defaults of China Post 25

Enable/Disable China Post 25



@CHPENA1
Enable China Post 25



@CHPENAO
Disable China Post 25



If the scanner fails to identify China Post 25 barcodes, you may first try this solution by scanning the **Enter Setup** barcode and then **Enable China Post 25** barcode.



@SETUPE0
**** Exit Setup**



@SETUPE1
Enter Setup

Set Length Range for China Post 25

The scanner can be configured to only decode China Post 25 barcodes with lengths that fall between (inclusive) the minimum and maximum lengths. To accomplish it, you need to set the minimum and maximum lengths.



@CHPMIN
Set the Minimum Length



@CHPMAX
Set the Maximum Length



If minimum length is set to be greater than maximum length, the scanner only decodes China Post 25 barcodes with either the minimum or maximum length. If minimum length is same as maximum length, only China Post 25 barcodes with that length are to be decoded.



Set the scanner to decode China Post 25 barcodes containing between 8 and 12 characters:

1. Scan the **Enter Setup** barcode.
2. Scan the **Set the Minimum Length** barcode.
3. Scan the numeric barcode “8” from the “Digit Barcodes” section in Appendix.
4. Scan the **Save** barcode from the “Save/Cancel Barcodes” section in Appendix.
5. Scan the **Set the Maximum Length** barcode.
6. Scan the numeric barcodes “1” and “2” from the “Digit Barcodes” section in Appendix.
7. Scan the **Save** barcode from the “Save/Cancel Barcodes” section in Appendix.
8. Scan the **Exit Setup** barcode.

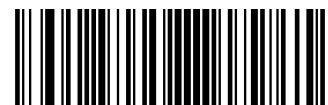

@SETUPE0
**** Exit Setup**



@SETUPE1
Enter Setup

Check Character Verification

A check character is optional for China Post 25 and can be added as the last character. It is a calculated value used to verify the integrity of the data.

- ✧ **Disable:** The scanner transmits China Post 25 barcodes as is.
- ✧ **Do Not Transmit Check Character After Verification:** The scanner checks the integrity of all China Post 25 barcodes to verify that the data complies with the check character algorithm. Barcodes passing the check will be transmitted except the last digit, whereas those failing it will not be transmitted.
- ✧ **Transmit Check Character After Verification:** The scanner checks the integrity of all China Post 25 barcodes to verify that the data complies with the check character algorithm. Barcodes passing the check will be transmitted, whereas those failing it will not be transmitted.



@CHPCHK0
Disable

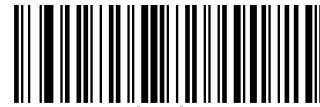

Do Not Transmit Check Character After Verification



Transmit Check Character After Verification



If the **Do Not Transmit Check Character After Verification** option is enabled, China Post 25 barcodes with a length that is less than the configured minimum length after having the check character excluded will not be decoded. (For example, when the **Do Not Transmit Check Character After Verification** option is enabled and the minimum length is set to 4, China Post 25 barcodes with a total length of 4 characters including the check character cannot be read.)



@SETUPE0
** Exit Setup



@SETUPE1
Enter Setup

GS1-128 (UCC/EAN-128)

Restore Factory Defaults



@GS1DEF

Restore the Factory Defaults of GS1-128

Enable/Disable GS1-128



@GS1ENA1

Enable GS1-128



@GS1ENA0

Disable GS1-128



If the scanner fails to identify GS1-128 barcodes, you may first try this solution by scanning the **EnterSetup** barcode and then **Enable GS1-128** barcode.

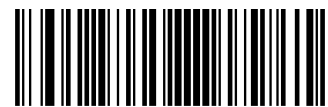

@SETUPE0
**** Exit Setup**



@SETUPE1
Enter Setup

Set Length Range for GS1-128

The scanner can be configured to only decode GS1-128 barcodes with lengths that fall between (inclusive) the minimum and maximum lengths. To accomplish it, you need to set the minimum and maximum lengths.



@GS1MIN
Set the Minimum Length



@GS1MAX
Set the Maximum Length



If minimum length is set to be greater than maximum length, the scanner only decodes GS1-128 barcodes with either the minimum or maximum length. If minimum length is same as maximum length, only GS1-128 barcodes with that length are to be decoded.



Set the scanner to decode GS1-128 barcodes containing between 8 and 12 characters:

1. Scan the **Enter Setup** barcode.
2. Scan the **Set the Minimum Length** barcode.
3. Scan the numeric barcode “8” from the “Digit Barcodes” section in Appendix.
4. Scan the **Save** barcode from the “Save/Cancel Barcodes” section in Appendix.
5. Scan the **Set the Maximum Length** barcode.
6. Scan the numeric barcodes “1” and “2” from the “Digit Barcodes” section in Appendix.
7. Scan the **Save** barcode from the “Save/Cancel Barcodes” section in Appendix.
8. Scan the **Exit Setup** barcode.



@SETUPE0
**** Exit Setup**



@SETUPE1
Enter Setup

GS1 Databar (RSS)

Restore Factory Defaults



@RSSDEF

Restore the Factory Defaults of GS1 Databar

Enable/Disable GS1 Databar



@RSSENA1

Enable GS1 Databar



@RSSENA0

Disable GS1 Databar



If the scanner fails to identify GS1 Databar barcodes, you may first try this solution by scanning the **Enter Setup** barcode and then **Enable GS1 Databar** barcode.

Transmit Application Identifier “01”



@RSSTAI1

Transmit Application Identifier “01”



@RSSTAI0

Do Not Transmit Application Identifier “01”



@SETUPE0
**** Exit Setup**



@SETUPE1
Enter Setup

GS1 Composite (EAN-UCC Composite)

Restore Factory Defaults



@CPTDEF
Restore the Factory Defaults of GS1 Composite

Enable/Disable GS1 Composite

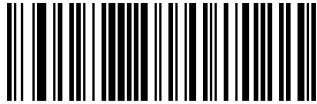

@CPTENA1
Enable GS1 Composite



@CPTENA0
Disable GS1 Composite



If the scanner fails to identify GS1 Composite barcodes, you may first try this solution by scanning the **Enter Setup** barcode and then **Enable GS1 Composite** barcode.



@SETUPE0
** Exit Setup



@SETUPE1
Enter Setup

Enable/Disable UPC/EAN Composite



@CPTUPC1
Enable UPC/EAN Composite



@CPTUPC0
Disable UPC/EAN Composite



@SETUPE0
**** Exit Setup**



@SETUPE1
Enter Setup

Code 11

Restore Factory Defaults



@C11DEF
Restore the Factory Defaults of Code 11

Enable/Disable Code 11



@C11ENA1
Enable Code 11



@C11ENA0
Disable Code 11



If the scanner fails to identify Code 11 barcodes, you may first try this solution by scanning the **Enter Setup** barcode and then **Enable Code 11** barcode.



@SETUPE0
**** Exit Setup**



@SETUPE1
Enter Setup

Set Length Range for Code 11

The scanner can be configured to only decode Code 11 barcodes with lengths that fall between (inclusive) the minimum and maximum lengths. To accomplish it, you need to set the minimum and maximum lengths.



@C11MIN
Set the Minimum Length



@C11MAX
Set the Maximum Length



If minimum length is set to be greater than maximum length, the scanner only decodes Code 11 barcodes with either the minimum or maximum length. If minimum length is same as maximum length, only Code 11 barcodes with that length are to be decoded.



Set the scanner to decode Code 11 barcodes containing between 8 and 12 characters:

1. Scan the **Enter Setup** barcode.
2. Scan the **Set the Minimum Length** barcode.
3. Scan the numeric barcode “8” from the “Digit Barcodes” section in Appendix.
4. Scan the **Save** barcode from the “Save/Cancel Barcodes” section in Appendix.
5. Scan the **Set the Maximum Length** barcode.
6. Scan the numeric barcodes “1” and “2” from the “Digit Barcodes” section in Appendix.
7. Scan the **Save** barcode from the “Save/Cancel Barcodes” section in Appendix.
8. Scan the **Exit Setup** barcode.

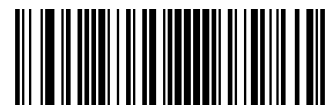

@SETUPE0
**** Exit Setup**



@SETUPE1
Enter Setup

Check Character Verification

Check characters are optional for Code 11 and can be added as the last one or two characters, which are calculated values used to verify the integrity of the data.

If the **Disable** option is enabled, the scanner transmits Code 11 barcodes as is.



@C11CHK0
Disable



@C11CHK1
One Check Character, MOD11



@C11CHK2
Two Check Characters, MOD11/MOD11



@C11CHK3
Two Check Characters, MOD11/MOD9



@C11CHK4
One Check Character, MOD11 (Len<=10)
Two Check Characters, MOD11/MOD11(Len>10)



@C11CHK5
One Check Character, MOD11 (Len<=10)
Two Check Characters, MOD11/MOD9 (Len>10)



@SETUPE0
**** Exit Setup**



@SETUPE1
Enter Setup

Transmit Check Character



@C11TCK0

Do Not Transmit Code 11 Check Character



@C11TCK1

Transmit Code 11 Check Character



If you select a check character algorithm and the **Do Not Transmit Check Character** option, Code 11 barcodes with a length that is less than the configured minimum length after having the check character(s) excluded will not be decoded. (For example, when the **One Check Character, MOD11** and **Do Not Transmit Check Character** options are enabled and the minimum length is set to 4, Code 11 barcodes with a total length of 4 characters including the check character cannot be read.)

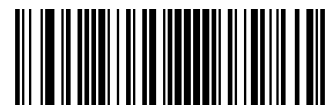

@SETUPE0
** Exit Setup



@SETUPE1
Enter Setup

ISBN

Restore Factory Defaults



@ISBDEF
Restore the Factory Defaults of ISBN

Enable/Disable ISBN



@ISBENA1
Enable ISBN



@ISBENA0
Disable ISBN



If the scanner fails to identify ISBN barcodes, you may first try this solution by scanning the **Enter Setup** barcode and then **Enable ISBN** barcode.



@SETUPE0
**** Exit Setup**



@SETUPE1

Enter Setup

Set ISBN Format



@ISBT101

ISBN-10



@ISBT100

ISBN-13

ISSN

Restore Factory Defaults



@ISSDEF

Restore the Factory Defaults of ISSN

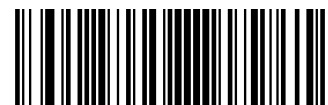

@SETUPE0

**** Exit Setup**



@SETUPE1

Enter Setup

Enable/Disable ISSN



@ISSENA1

Enable ISSN



@ISSENA0

Disable ISSN



If the scanner fails to identify ISSN barcodes, you may first try this solution by scanning the **Enter Setup** barcode and then **Enable ISSN** barcode.



@SETUPE0

**** Exit Setup**



@SETUPE1
Enter Setup

Industrial 25

Restore Factory Defaults



@L25DEF

Restore the Factory Defaults of Industrial 25

Enable/Disable Industrial 25



@L25ENA1

Enable Industrial 25



@L25ENA0

Disable Industrial 25



If the scanner fails to identify Industrial 25 barcodes, you may first try this solution by scanning the **Enter Setup** barcode and then **Enable Industrial 25** barcode.



@SETUPE0
**** Exit Setup**



@SETUPE1
Enter Setup

Set Length Range for Industrial 25

The scanner can be configured to only decode Industrial 25 barcodes with lengths that fall between (inclusive) the minimum and maximum lengths. To accomplish it, you need to set the minimum and maximum lengths.



@L25MIN
Set the Minimum Length



@L25MAX
Set the Maximum Length



If minimum length is set to be greater than maximum length, the scanner only decodes Industrial 25 barcodes with either the minimum or maximum length. If minimum length is same as maximum length, only Industrial 25 barcodes with that length are to be decoded.



Set the scanner to decode Industrial 25 barcodes containing between 8 and 12 characters:

1. Scan the **Enter Setup** barcode.
2. Scan the **Set the Minimum Length** barcode.
3. Scan the numeric barcode “8” from the “Digit Barcodes” section in Appendix.
4. Scan the **Save** barcode from the “Save/Cancel Barcodes” section in Appendix.
5. Scan the **Set the Maximum Length** barcode.
6. Scan the numeric barcodes “1” and “2” from the “Digit Barcodes” section in Appendix.
7. Scan the **Save** barcode from the “Save/Cancel Barcodes” section in Appendix.
8. Scan the **Exit Setup** barcode.



@SETUPE0
**** Exit Setup**



@SETUPE1
Enter Setup

Check Character Verification

A check character is optional for Industrial 25 and can be added as the last character. It is a calculated value used to verify the integrity of the data.

- ✧ **Disable:** The scanner transmits Industrial 25 barcodes as is.
- ✧ **Do Not Transmit Check Character After Verification:** The scanner checks the integrity of all Industrial 25 barcodes to verify that the data complies with the check character algorithm. Barcodes passing the check will be transmitted except the last digit, whereas those failing it will not be transmitted.
- ✧ **Transmit Check Character After Verification:** The scanner checks the integrity of all Industrial 25 barcodes to verify that the data complies with the check character algorithm. Barcodes passing the check will be transmitted, whereas those failing it will not be transmitted.



@L25CHK0
Disable



@L25CHK1
Do Not Transmit Check Character After Verification



@L25CHK2
Transmit Check Character After Verification



If the **Do Not Transmit Check Character After Verification** option is enabled, Industrial 25 barcodes with a length that is less than the configured minimum length after having the check character excluded will not be decoded. (For example, when the **Do Not Transmit Check Character After Verification** option is enabled and the minimum length is set to 4, Industrial 25 barcodes with a total length of 4 characters including the check character cannot be read.)



@SETUPE0
** Exit Setup



@SETUPE1
Enter Setup

Standard 25

Restore Factory Defaults



@S25DEF
Restore the Factory Defaults of Standard 25

Enable/Disable Standard 25



@S25ENA1
Enable Standard 25



@S25ENA0
Disable Standard 25



If the scanner fails to identify Standard 25 barcodes, you may first try this solution by scanning the **Enter Setup** barcode and then **Enable Standard 25** barcode.



@SETUPE0
**** Exit Setup**



@SETUPE1
Enter Setup

Set Length Range for Standard 25

The scanner can be configured to only decode Standard 25 barcodes with lengths that fall between (inclusive) the minimum and maximum lengths. To accomplish it, you need to set the minimum and maximum lengths.



Set the Minimum Length



Set the Maximum Length



If minimum length is set to be greater than maximum length, the scanner only decodes Standard 25 barcodes with either the minimum or maximum length. If minimum length is same as maximum length, only Standard 25 barcodes with that length are to be decoded.



Set the scanner to decode Standard 25 barcodes containing between 8 and 12 characters:

1. Scan the **Enter Setup** barcode.
2. Scan the **Set the Minimum Length** barcode.
3. Scan the numeric barcode “8” from the “Digit Barcodes” section in Appendix.
4. Scan the **Save** barcode from the “Save/Cancel Barcodes” section in Appendix.
5. Scan the **Set the Maximum Length** barcode.
6. Scan the numeric barcodes “1” and “2” from the “Digit Barcodes” section in Appendix.
7. Scan the **Save** barcode from the “Save/Cancel Barcodes” section in Appendix.
8. Scan the **Exit Setup** barcode.



@SETUPE0
**** Exit Setup**



@SETUPE1
Enter Setup

Check Character Verification

A check character is optional for Standard 25 and can be added as the last character. It is a calculated value used to verify the integrity of the data.

- ✧ **Disable:** The scanner transmits Standard 25 barcodes as is.
- ✧ **Do Not Transmit Check Character After Verification:** The scanner checks the integrity of all Standard 25 barcodes to verify that the data complies with the check character algorithm. Barcodes passing the check will be transmitted except the last digit, whereas those failing it will not be transmitted.
- ✧ **Transmit Check Character After Verification:** The scanner checks the integrity of all Standard 25 barcodes to verify that the data complies with the check character algorithm. Barcodes passing the check will be transmitted, whereas those failing it will not be transmitted.



@S25CHK0
Disable

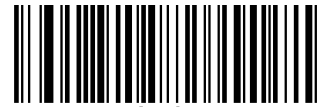

@S25CHK1
Do Not Transmit Check Character After Verification



@S25CHK2
Transmit Check Character After Verification



If the **Do Not Transmit Check Character After Verification** option is enabled, Standard 25 barcodes with a length that is less than the configured minimum length after having the check character excluded will not be decoded. (For example, when the **Do Not Transmit Check Character After Verification** option is enabled and the minimum length is set to 4, Standard 25 barcodes with a total length of 4 characters including the check character cannot be read.)



@SETUPE0
** Exit Setup



@SETUPE1
Enter Setup

Plessey

Restore Factory Defaults



@PLYDEF

Restore the Factory Defaults of Plessey

Enable/Disable Plessey



@PLYENA1

Enable Plessey



@PLYENA0

Disable Plessey



If the scanner fails to identify Plessey barcodes, you may first try this solution by scanning the **Enter Setup** barcode and then **Enable Plessey** barcode.

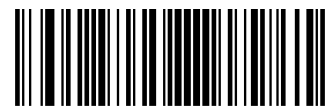

@SETUPE0
**** Exit Setup**



@SETUPE1
Enter Setup

Set Length Range for Plessey

The scanner can be configured to only decode Plessey barcodes with lengths that fall between (inclusive) the minimum and maximum lengths. To accomplish it, you need to set the minimum and maximum lengths.



@PLYMIN
Set the Minimum Length



@PLYMAX
Set the Maximum Length



If minimum length is set to be greater than maximum length, the scanner only decodes Plessey barcodes with either the minimum or maximum length. If minimum length is same as maximum length, only Plessey barcodes with that length are to be decoded.



Set the scanner to decode Plessey barcodes containing between 8 and 12 characters:

1. Scan the **Enter Setup** barcode.
2. Scan the **Set the Minimum Length** barcode.
3. Scan the numeric barcode “8” from the “Digit Barcodes” section in Appendix.
4. Scan the **Save** barcode from the “Save/Cancel Barcodes” section in Appendix.
5. Scan the **Set the Maximum Length** barcode.
6. Scan the numeric barcodes “1” and “2” from the “Digit Barcodes” section in Appendix.
7. Scan the **Save** barcode from the “Save/Cancel Barcodes” section in Appendix.
8. Scan the **Exit Setup** barcode.



@SETUPE0
**** Exit Setup**



@SETUPE1
Enter Setup

Check Character Verification

Check characters are optional for Plessey and can be added as the last two characters, which are calculated values used to verify the integrity of the data.

- ✧ **Disable:** The scanner transmits Plessey barcodes as is.
- ✧ **Do Not Transmit Check Character After Verification:** The scanner checks the integrity of all Plessey barcodes to verify that the data complies with the check character algorithm. Barcodes passing the checks will be transmitted except the last two digits, whereas those failing them will not be transmitted.
- ✧ **Transmit Check Character After Verification:** The scanner checks the integrity of all Plessey barcodes to verify that the data complies with the check character algorithm. Barcodes passing the checks will be transmitted, whereas those failing them will not be transmitted.



@PLYCHK0
Disable

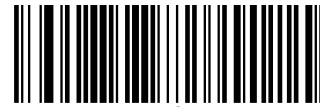

@PLYCHK1
Do Not Transmit Check Character After Verification



@PLYCHK2
Transmit Check Character After Verification



If the **Do Not Transmit Check Character After Verification** option is enabled, Plessey barcodes with a length that is less than the configured minimum length after having the check characters excluded will not be decoded. (For example, when the **Do Not Transmit Check Character After Verification** option is enabled and the minimum length is set to 4, Plessey barcodes with a total length of 4 characters including the check characters cannot be read.)



@SETUPE0
** Exit Setup



@SETUPE1
Enter Setup

MSI-Plessey

Restore Factory Defaults



@MSIDF
Restore the Factory Defaults of MSI-Plessey

Enable/Disable MSI-Plessey



@MSIENA1
Enable MSI-Plessey



@MSIENA0
Disable MSI-Plessey



If the scanner fails to identify MSI-Plessey barcodes, you may first try this solution by scanning the **Enter Setup** barcode and then **Enable MSI-Plessey** barcode.



@SETUPE0
**** Exit Setup**



@SETUPE1
Enter Setup

Set Length Range for MSI-Plessey

The scanner can be configured to only decode MSI-Plessey barcodes with lengths that fall between (inclusive) the minimum and maximum lengths. To accomplish it, you need to set the minimum and maximum lengths.



Set the Minimum Length



Set the Maximum Length



If minimum length is set to be greater than maximum length, the scanner only decodes MSI-Plessey barcodes with either the minimum or maximum length. If minimum length is same as maximum length, only MSI-Plessey barcodes with that length are to be decoded.



Set the scanner to decode MSI-Plessey barcodes containing between 8 and 12 characters:

1. Scan the **Enter Setup** barcode.
2. Scan the **Set the Minimum Length** barcode.
3. Scan the numeric barcode “8” from the “Digit Barcodes” section in Appendix.
4. Scan the **Save** barcode from the “Save/Cancel Barcodes” section in Appendix.
5. Scan the **Set the Maximum Length** barcode.
6. Scan the numeric barcodes “1” and “2” from the “Digit Barcodes” section in Appendix.
7. Scan the **Save** barcode from the “Save/Cancel Barcodes” section in Appendix.
8. Scan the **Exit Setup** barcode.

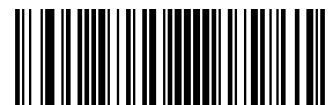

@SETUPE0
**** Exit Setup**



@SETUPE1
Enter Setup

Check Character Verification

Check characters are optional for MSI-Plessey and can be added as the last one or two characters, which are calculated values used to verify the integrity of the data.

If the **Disable** option is enabled, the scanner transmits MSI-Plessey barcodes as is.

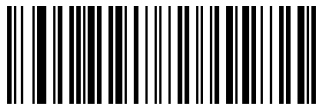

@MSICLK0
Disable



@MSICLK1
One Check Character, MOD10

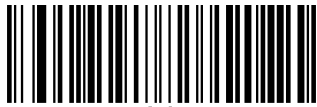

@MSICLK2
Two Check Characters, MOD10/MOD10



@MSICLK3
Two Check Characters, MOD10/MOD11



@SETUPE0
**** Exit Setup**



@SETUPE1

Enter Setup

Transmit Check Character



@MSITCK1

Transmit MSI-Plessey Check Character



@MSITCK0

Do Not Transmit MSI-Plessey Check Character



If you select a check character algorithm and the **Do Not Transmit Check Character** option, MSI-Plessey barcodes with a length that is less than the configured minimum length after having the check character(s) excluded will not be decoded. (For example, when the **One Check Character, MOD10** and **Do Not Transmit Check Character** options are enabled and the minimum length is set to 4, MSI-Plessey barcodes with a total length of 4 characters including the check character cannot be read.)

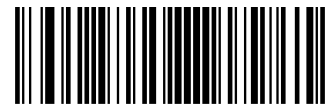

@SETUPE0

** Exit Setup



@SETUPE1
Enter Setup

AIM 128

Restore Factory Defaults



@AIMDEF
Restore the Factory Defaults of AIM 128

Enable/Disable AIM 128



@AIMENA1
Enable AIM 128



@AIMENA0
Disable AIM 128



If the scanner fails to identify AIM 128 barcodes, you may first try this solution by scanning the **Enter Setup** barcode and then **Enable AIM 128** barcode.



@SETUPE0
**** Exit Setup**



@SETUPE1
Enter Setup

Set Length Range for AIM 128

The scanner can be configured to only decode AIM 128 barcodes with lengths that fall between (inclusive) the minimum and maximum lengths. To accomplish it, you need to set the minimum and maximum lengths.



@AIMMIN
Set the Minimum Length



@AIMMAX
Set the Maximum Length



If minimum length is set to be greater than maximum length, the scanner only decodes AIM 128 barcodes with either the minimum or maximum length. If minimum length is same as maximum length, only AIM 128 barcodes with that length are to be decoded.



Set the scanner to decode AIM 128 barcodes containing between 8 and 12 characters:

1. Scan the **Enter Setup** barcode.
2. Scan the **Set the Minimum Length** barcode.
3. Scan the numeric barcode “8” from the “Digit Barcodes” section in Appendix.
4. Scan the **Save** barcode from the “Save/Cancel Barcodes” section in Appendix.
5. Scan the **Set the Maximum Length** barcode.
6. Scan the numeric barcodes “1” and “2” from the “Digit Barcodes” section in Appendix.
7. Scan the **Save** barcode from the “Save/Cancel Barcodes” section in Appendix.
8. Scan the **Exit Setup** barcode.

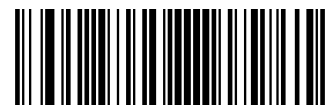

@SETUPE0
**** Exit Setup**



@SETUPE1
Enter Setup

ISBT 128

Restore Factory Defaults



@IBTDEF
Restore the Factory Defaults of ISBT 128

Enable/Disable ISBT 128



@IBTENA1
Enable ISBT 128



@IBTENA0
Disable ISBT 128



If the scanner fails to identify ISBT 128 barcodes, you may first try this solution by scanning the **Enter Setup** barcode and then **Enable ISBT 128** barcode.



@SETUPE0
**** Exit Setup**



@SETUPE1
Enter Setup

Code 49

Restore Factory Defaults



@C49DEF

Restore the Factory Defaults of Code 49

Enable/Disable Code 49



@C49ENA1

Enable Code 49



@C49ENA0

Disable Code 49



If the scanner fails to identify Code 49 barcodes, you may first try this solution by scanning the **Enter Setup** barcode and then **Enable Code 49** barcode.



@SETUPE0
**** Exit Setup**



@SETUPE1
Enter Setup

Set Length Range for Code 49

The scanner can be configured to only decode Code 49 barcodes with lengths that fall between (inclusive) the minimum and maximum lengths. To accomplish it, you need to set the minimum and maximum lengths.



@C49MIN
Set the Minimum Length



@C49MAX
Set the Maximum Length



If minimum length is set to be greater than maximum length, the scanner only decodes Code 49 barcodes with either the minimum or maximum length. If minimum length is same as maximum length, only Code 49 barcodes with that length are to be decoded.



Set the scanner to decode Code 49 barcodes containing between 8 and 12 characters:

1. Scan the **Enter Setup** barcode.
2. Scan the **Set the Minimum Length** barcode.
3. Scan the numeric barcode “8” from the “Digit Barcodes” section in Appendix.
4. Scan the **Save** barcode from the “Save/Cancel Barcodes” section in Appendix.
5. Scan the **Set the Maximum Length** barcode.
6. Scan the numeric barcodes “1” and “2” from the “Digit Barcodes” section in Appendix.
7. Scan the **Save** barcode from the “Save/Cancel Barcodes” section in Appendix.
8. Scan the **Exit Setup** barcode.



@SETUPE0
**** Exit Setup**



@SETUPE1
Enter Setup

Code 16K

Restore Factory Defaults



@16KDEF

Restore the Factory Defaults of Code 16K

Enable/Disable Code 16K



@16KENA1

Enable Code 16K



@16KENA0

Disable Code 16K



If the scanner fails to identify Code 16K barcodes, you may first try this solution by scanning the **Enter Setup** barcode and then **Enable Code 16K** barcode.

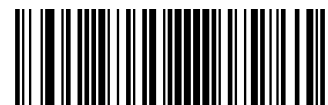

@SETUPE0
**** Exit Setup**



@SETUPE1
Enter Setup

Set Length Range for Code 16K

The scanner can be configured to only decode Code 16K barcodes with lengths that fall between (inclusive) the minimum and maximum lengths. To accomplish it, you need to set the minimum and maximum lengths.



@16KMIN
Set the Minimum Length



@16KMAX
Set the Maximum Length



If minimum length is set to be greater than maximum length, the scanner only decodes Code 16K barcodes with either the minimum or maximum length. If minimum length is same as maximum length, only Code 16K barcodes with that length are to be decoded.



Set the scanner to decode Code 16K barcodes containing between 8 and 12 characters:

1. Scan the **Enter Setup** barcode.
2. Scan the **Set the Minimum Length** barcode.
3. Scan the numeric barcode “8” from the “Digit Barcodes” section in Appendix.
4. Scan the **Save** barcode from the “Save/Cancel Barcodes” section in Appendix.
5. Scan the **Set the Maximum Length** barcode.
6. Scan the numeric barcodes “1” and “2” from the “Digit Barcodes” section in Appendix.
7. Scan the **Save** barcode from the “Save/Cancel Barcodes” section in Appendix.
8. Scan the **Exit Setup** barcode.



@SETUPE0
**** Exit Setup**



@SETUPE1
Enter Setup

PDF417

Restore Factory Defaults



@PDFDEF

Restore the Factory Defaults of PDF417

Enable/Disable PDF417



@PDFENA1

Enable PDF417



@PDFENA0

Disable PDF417



If the scanner fails to identify PDF417 barcodes, you may first try this solution by scanning the **Enter Setup** barcode and then **Enable PDF417** barcode.

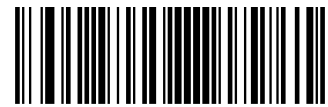

@SETUPE0
**** Exit Setup**



@SETUPE1
Enter Setup

Set Length Range for PDF417

The scanner can be configured to only decode PDF417 barcodes with lengths that fall between (inclusive) the minimum and maximum lengths. To accomplish it, you need to set the minimum and maximum lengths.



@PDFMIN
Set the Minimum Length



@PDFMAX
Set the Maximum Length



Minimum length is not allowed to be greater than maximum length. If you only want to read PDF417 barcodes with a specific length, set both minimum and maximum lengths to be that desired length.



Set the scanner to decode PDF417 barcodes containing between 8 and 12 characters:

1. Scan the **Enter Setup** barcode.
2. Scan the **Set the Minimum Length** barcode.
3. Scan the numeric barcode “8” from the “Digit Barcodes” section in Appendix.
4. Scan the **Save** barcode from the “Save/Cancel Barcodes” section in Appendix.
5. Scan the **Set the Maximum Length** barcode.
6. Scan the numeric barcodes “1” and “2” from the “Digit Barcodes” section in Appendix.
7. Scan the **Save** barcode from the “Save/Cancel Barcodes” section in Appendix.
8. Scan the **Exit Setup** barcode.



@SETUPE0
**** Exit Setup**



@SETUPE1
Enter Setup

PDF417 Twin Code

PDF417 twin code is 2 PDF417 barcodes paralleled vertically or horizontally. They must both be either regular or inverse barcodes. They must have similar specifications and be placed closely together.

There are 3 options for reading PDF417 twin codes:

- ◇ **Single PDF417 Only:** Read either PDF417 code.
- ◇ **Twin PDF417 Only:** Read both PDF417 codes.
- ◇ **Both Single & Twin:** Read both PDF417 codes. If successful, transmit as twin PDF417 only. Otherwise, try single PDF417 only.



@PDFDOU0
Single PDF417 Only



@PDFDOU1
Twin PDF417 Only



@PDFDOU2
Both Single & Twin



@SETUPE0
**** Exit Setup**



@SETUPE1
Enter Setup

PDF417 Inverse

Regular barcode: Dark bars on a bright background.

Inverse barcode: Bright bars on a dark background.



@PDFINV0

Decode Regular PDF417 Barcodes Only



@PDFINV1

Decode Inverse PDF417 Barcodes Only



@PDFINV2

Decode Both

Character Encoding



@PDFENC0

Default Character Encoding

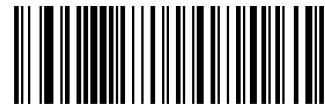

@PDFENC1

UTF-8



@PDFENC2

Automatically Select UTF-8 or Code Page



@SETUPE0
** Exit Setup



@SETUPE1

Enter Setup

PDF417 ECI Output



@PDFECI0

Disable PDF417 ECI Output



@PDFECI1

Enable PDF417 ECI Output

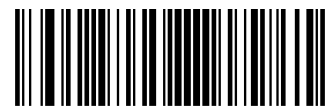

@SETUPE0

**** Exit Setup**



@SETUPE1
Enter Setup

Micro PDF417

Restore Factory Defaults



@MPDDEF
Restore the Factory Defaults of Micro PDF417

Enable/Disable Micro PDF417



@MPDENA1
Enable Micro PDF417



@MPDENA0
Disable Micro PDF417



If the scanner fails to identify Micro PDF417 barcodes, you may first try this solution by scanning the **Enter Setup** barcode and then **Enable Micro PDF417** barcode.



@SETUPE0
**** Exit Setup**



@SETUPE1
Enter Setup

Set Length Range for Micro PDF417

The scanner can be configured to only decode Micro PDF417 barcodes with lengths that fall between (inclusive) the minimum and maximum lengths. To accomplish it, you need to set the minimum and maximum lengths.



Set the Minimum Length



Set the Maximum Length



Minimum length is not allowed to be greater than maximum length. If you only want to read Micro PDF417 barcodes with a specific length, set both minimum and maximum lengths to be that desired length.



Set the scanner to decode Micro PDF417 barcodes containing between 8 and 12 characters:

1. Scan the **Enter Setup** barcode.
2. Scan the **Set the Minimum Length** barcode.
3. Scan the numeric barcode “8” from the “Digit Barcodes” section in Appendix.
4. Scan the **Save** barcode from the “Save/Cancel Barcodes” section in Appendix.
5. Scan the **Set the Maximum Length** barcode.
6. Scan the numeric barcodes “1” and “2” from the “Digit Barcodes” section in Appendix.
7. Scan the **Save** barcode from the “Save/Cancel Barcodes” section in Appendix.
8. Scan the **Exit Setup** barcode.

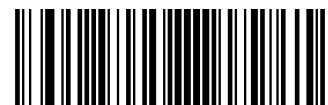

@SETUPE0
**** Exit Setup**



@SETUPE1
Enter Setup

QR Code

Restore Factory Defaults



@QRCDEF
Restore the Factory Defaults of QR Code

Enable/Disable QR Code



@QRCENA1
Enable QR Code



@QRCENA0
Disable QR Code



If the scanner fails to identify QR Code barcodes, you may first try this solution by scanning the **Enter Setup** barcode and then **Enable QR Code** barcode.



@SETUPE0
**** Exit Setup**



@SETUPE1
Enter Setup

Set Length Range for QR Code

The scanner can be configured to only decode QR Code barcodes with lengths that fall between (inclusive) the minimum and maximum lengths. To accomplish it, you need to set the minimum and maximum lengths.



Set the Minimum Length



Set the Maximum Length



Minimum length is not allowed to be greater than maximum length. If you only want to read QR Code barcodes with a specific length, set both minimum and maximum lengths to be that desired length.



Set the scanner to decode QR Code barcodes containing between 8 and 12 characters:

1. Scan the **Enter Setup** barcode.
2. Scan the **Set the Minimum Length** barcode.
3. Scan the numeric barcode “8” from the “Digit Barcodes” section in Appendix.
4. Scan the **Save** barcode from the “Save/Cancel Barcodes” section in Appendix.
5. Scan the **Set the Maximum Length** barcode.
6. Scan the numeric barcodes “1” and “2” from the “Digit Barcodes” section in Appendix.
7. Scan the **Save** barcode from the “Save/Cancel Barcodes” section in Appendix.
8. Scan the **Exit Setup** barcode.



@SETUPE0
**** Exit Setup**



@SETUPE1
Enter Setup

QR Twin Code

QR twin code is 2 QR barcodes paralleled vertically or horizontally. They must both be either regular or inverse barcodes. They must have similar specifications and be placed closely together.

There are 3 options for reading PDF417 twin codes:

- ◇ **Single QR Only:** Read either QR code.
- ◇ **Twin QR Only:** Read both QR codes.
- ◇ **Both Single & Twin:** Read both QR codes. If successful, transmit as twin QR only. Otherwise, try single QR only.



@QRCDU0
Single QR Only



@QRCDU1
Twin QR Only



@QRCDU2
Both Single & Twin



@SETUPE0
**** Exit Setup**



@SETUPE1

Enter Setup

QR Inverse

Regular barcode: Dark bars on a bright background.

Inverse barcode: Bright bars on a dark background.



@QRCINV0

Decode Regular QR Barcodes Only



@QRCINV1

Decode Inverse QR Barcodes Only



@QRCINV2

Decode Both

Character Encoding



@QRCENC0

Default Character Encoding



@QRCENC1

UTF-8



@QRCENC3

Automatically Select UTF-8 or Code Page

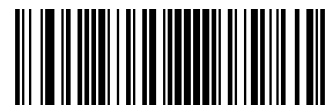

@SETUPE0

** Exit Setup



@SETUPE1

Enter Setup



@SETUPE0

**** Exit Setup**



@SETUPE1
Enter Setup

QR ECI Output



@QRCECI0
Disable QR ECI Output



@QRCECI1
Enable QR ECI Output

URL QR

URL QR code refers to QR code whose barcode data begins with the http or HTTP.



@QRCURL0
Disable URL QR



@QRCURL1
Enable URL QR



@SETUPE0
**** Exit Setup**



@SETUPE1
Enter Setup

Micro QR Code

Restore Factory Defaults



@MQRDEF
Restore the Factory Defaults of Micro QR

Enable/Disable Micro QR



@MQRENA1
Enable Micro QR



@MQRENA0
Disable Micro QR



If the scanner fails to identify Micro QR barcodes, you may first try this solution by scanning the **Enter Setup** barcode and then **Enable Micro QR** barcode.



@SETUPE0
**** Exit Setup**



@SETUPE1
Enter Setup

Set Length Range for Micro QR

The scanner can be configured to only decode Micro QR barcodes with lengths that fall between (inclusive) the minimum and maximum lengths. To accomplish it, you need to set the minimum and maximum lengths.



@MQRMIN
Set the Minimum Length



@MQRMAX
Set the Maximum Length



Minimum length is not allowed to be greater than maximum length. If you only want to read Micro QR barcodes with a specific length, set both minimum and maximum lengths to be that desired length.



Set the scanner to decode Micro QR Code barcodes containing between 8 and 12 characters:

1. Scan the **Enter Setup** barcode.
2. Scan the **Set the Minimum Length** barcode.
3. Scan the numeric barcode “8” from the “Digit Barcodes” section in Appendix.
4. Scan the **Save** barcode from the “Save/Cancel Barcodes” section in Appendix.
5. Scan the **Set the Maximum Length** barcode.
6. Scan the numeric barcodes “1” and “2” from the “Digit Barcodes” section in Appendix.
7. Scan the **Save** barcode from the “Save/Cancel Barcodes” section in Appendix.
8. Scan the **Exit Setup** barcode.



@SETUPE0
**** Exit Setup**



@SETUPE1
Enter Setup

Aztec

Restore Factory Defaults



@AZTDEF
Restore the Factory Defaults of Aztec Code

Enable/Disable Aztec Code



@AZTENA1
Enable Aztec Code



@AZTENA0
Disable Aztec Code



If the scanner fails to identify Aztec Code barcodes, you may first try this solution by scanning the **Enter Setup** barcode and then **Enable Aztec Code** barcode.



@SETUPE0
** Exit Setup



@SETUPE1
Enter Setup

Set Length Range for Aztec Code

The scanner can be configured to only decode Aztec barcodes with lengths that fall between (inclusive) the minimum and maximum lengths. To accomplish it, you need to set the minimum and maximum lengths.



@AZTMIN
Set the Minimum Length



@AZTMAX
Set the Maximum Length



Minimum length is not allowed to be greater than maximum length. If you only want to read Aztec barcodes with a specific length, set both minimum and maximum lengths to be that desired length.



Set the scanner to decode Aztec barcodes containing between 8 and 12 characters:

1. Scan the **Enter Setup** barcode.
2. Scan the **Set the Minimum Length** barcode.
3. Scan the numeric barcode “8” from the “Digit Barcodes” section in Appendix.
4. Scan the **Save** barcode from the “Save/Cancel Barcodes” section in Appendix.
5. Scan the **Set the Maximum Length** barcode.
6. Scan the numeric barcodes “1” and “2” from the “Digit Barcodes” section in Appendix.
7. Scan the **Save** barcode from the “Save/Cancel Barcodes” section in Appendix.
8. Scan the **Exit Setup** barcode.



@SETUPE0
**** Exit Setup**



@SETUPE1
Enter Setup

Read Multi-barcodes on an Image

There are three options:

- ◇ **Mode 1:** Read one barcode only.
- ◇ **Mode 2:** Read fixed number of barcodes only.
- ◇ **Mode 3:** Composite Reading. Read fixed number of barcodes first. If unsuccessful, read one barcode only.



@AZTMOD1
Mode 1



@AZTMOD2
Mode 2

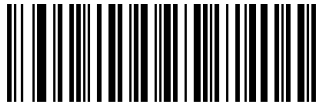

@AZTMOD3
Mode 3



@SETUPE0
**** Exit Setup**



@SETUPE1
Enter Setup

Set the Number of Barcodes



@AZTMUL1

1



@AZTMUL2

2

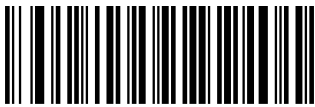

@AZTMUL3

3



@AZTMUL4

4

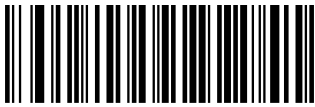

@AZTMUL5

5



@AZTMUL6

6

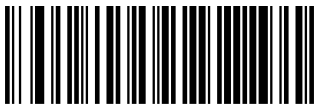

@AZTMUL7

7



@AZTMUL8

8



@SETUPE0
** Exit Setup



@SETUPE1
Enter Setup

Character Encoding



@AZTENC0
Default Character Encoding



@AZTENC1
UTF-8



@AZTENC2
Automatically Select UTF-8 or Code Page

Aztec ECI Output



@AZTECI0
Disable Aztec ECI Output



@AZTECI1
Enable Aztec ECI Output



@SETUPE0
**** Exit Setup**



@SETUPE1
Enter Setup

Data Matrix

Restore Factory Defaults



@DMCDEF

Restore the Factory Defaults of Data Matrix

Enable/Disable Data Matrix



@DMCENA1

Enable Data Matrix



@DMCENA0

Disable Data Matrix



If the scanner fails to identify Data Matrix barcodes, you may first try this solution by scanning the **Enter Setup** barcode and then **Enable Data Matrix** barcode.



@SETUPE0
**** Exit Setup**



@SETUPE1
Enter Setup

Set Length Range for Data Matrix

The scanner can be configured to only decode Data Matrix barcodes with lengths that fall between (inclusive) the minimum and maximum lengths. To accomplish it, you need to set the minimum and maximum lengths.



@DMCMIN
Set the Minimum Length



@DMCMAX
Set the Maximum Length



Minimum length is not allowed to be greater than maximum length. If you only want to read Data Matrix barcodes with a specific length, set both minimum and maximum lengths to be that desired length.



Set the scanner to decode Data Matrix barcodes containing between 8 and 12 characters:

1. Scan the **Enter Setup** barcode.
2. Scan the **Set the Minimum Length** barcode.
3. Scan the numeric barcode “8” from the “Digit Barcodes” section in Appendix.
4. Scan the **Save** barcode from the “Save/Cancel Barcodes” section in Appendix.
5. Scan the **Set the Maximum Length** barcode.
6. Scan the numeric barcodes “1” and “2” from the “Digit Barcodes” section in Appendix.
7. Scan the **Save** barcode from the “Save/Cancel Barcodes” section in Appendix.
8. Scan the **Exit Setup** barcode.



@SETUPE0
**** Exit Setup**



@SETUPE1
Enter Setup

Data Matrix Twin Code

Data Matrix twin code is 2 Data Matrix barcodes paralleled vertically or horizontally. They must both be either regular or inverse barcodes. They must have similar specifications and be placed closely together.

There are 3 options for reading Data Matrix twin codes:

- ◇ **Single Data Matrix Only:** Read either Data Matrix code.
- ◇ **Twin Data Matrix Only:** Read both Data Matrix codes. Transmission sequence: left (upper) Data Matrix code followed by right (lower) Data Matrix code.
- ◇ **Both Single & Twin:** Read both Data Matrix codes. If successful, transmit as twin Data Matrix only. Otherwise, try single Data Matrix only.



@DMCDOU0
Single Data Matrix Only



@DMCDOU1
Twin Data Matrix Only



@DMCDOU2
Both Single & Twin



@SETUPE0
**** Exit Setup**



@SETUPE1
Enter Setup

Rectangular Barcode

Data Matrix has two formats:

Square barcodes having the same amount of modules in length and width: 10*10, 12*12.... 144*144.

Rectangular barcodes having different amounts of models in length and width: 6*16, 6*14...14*22.



@DMCREC1
Enable Rectangular Barcode



@DMCREC0
Disable Rectangular Barcode

Data Matrix Inverse

Regular barcode: Dark bars on a bright background.

Inverse barcode: Bright bars on a dark background.



@DMCINV0
Decode Regular Data Matrix Barcodes Only



@DMCINV1
Decode Inverse Data Matrix Barcodes Only



@DMCINV2
Decode Both



@SETUPE0
** Exit Setup



@SETUPE1
Enter Setup

Character Encoding



@DMCENC0
Default Character Encoding



@DMCENC1
UTF-8



@DMCENC2
Automatically Select UTF-8 or Code Page

Data Matrix ECI Output



@DMCECI0
Disable Data Matrix ECI Output



@DMCECI1
Enable Data Matrix ECI Output



@SETUPE0
**** Exit Setup**



@SETUPE1
Enter Setup

Chinese Sensible Code

Restore Factory Defaults



@CSCDEF
Restore the Factory Defaults of Chinese Sensible Code

Enable/Disable Chinese Sensible Code



@CSCENA1
Enable Chinese Sensible Code



@CSCENA0
Disable Chinese Sensible Code



If the scanner fails to identify Chinese Sensible Code barcodes, you may first try this solution by scanning the **Enter Setup** barcode and then **Enable Chinese Sensible Code** barcode.



@SETUPE0
**** Exit Setup**



@SETUPE1
Enter Setup

Set Length Range for Chinese Sensible Code

The scanner can be configured to only decode Chinese Sensible Code barcodes with lengths that fall between (inclusive) the minimum and maximum lengths. To accomplish it, you need to set the minimum and maximum lengths.



Set the Minimum Length



Set the Maximum Length



Minimum length is not allowed to be greater than maximum length. If you only want to read Chinese Sensible Code barcodes with a specific length, set both minimum and maximum lengths to be that desired length.



Set the scanner to decode Chinese Sensible Code barcodes containing between 8 and 12 characters:

1. Scan the **Enter Setup** barcode.
2. Scan the **Set the Minimum Length** barcode.
3. Scan the numeric barcode “8” from the “Digit Barcodes” section in Appendix.
4. Scan the **Save** barcode from the “Save/Cancel Barcodes” section in Appendix.
5. Scan the **Set the Maximum Length** barcode.
6. Scan the numeric barcodes “1” and “2” from the “Digit Barcodes” section in Appendix.
7. Scan the **Save** barcode from the “Save/Cancel Barcodes” section in Appendix.
8. Scan the **Exit Setup** barcode.

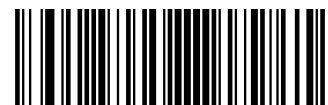

@SETUPE0
**** Exit Setup**



@SETUPE1
Enter Setup

Chinese Sensible Twin Code

Chinese Sensible twin code is 2 Chinese Sensible barcodes paralleled vertically or horizontally. They must both be either regular or inverse barcodes. They must have similar specifications and be placed closely together.

There are 3 options for reading Chinese Sensible twin codes:

- ✧ **Single Chinese Sensible Code Only:** Read either Chinese Sensible code.
- ✧ **Twin Chinese Sensible Code Only:** Read both Chinese Sensible codes. Transmission sequence: left (upper) Chinese Sensible code followed by right (lower) Chinese Sensible code.
- ✧ **Both Single & Twin:** Read both Chinese Sensible codes. If successful, transmit as twin Chinese Sensible Code only. Otherwise, try single Chinese Sensible Code only.



@CSCDOU0

Single Chinese Sensible Code Only



@CSCDOU1

Twin Chinese Sensible Code Only



@CSCDOU2

Both Single & Twin



@SETUPE0
**** Exit Setup**



@SETUPE1
Enter Setup

Chinese Sensible Code Inverse

Regular barcode: Dark bars on a bright background.

Inverse barcode: Bright bars on a dark background.



@CSCINV0

Decode Regular Chinese Sensible Barcodes Only



@CSCINV1

Decode Inverse Chinese Sensible Barcodes Only



@CSCINV2

Decode Both



@SETUPE0
**** Exit Setup**



@SETUPE1
Enter Setup

GM Code

Restore Factory Defaults



@GMCDEF
Restore the Factory Defaults of GM

Enable/Disable GM



@GMCENA1
Enable GM



@GMCENA0
Disable GM



If the scanner fails to identify GM barcodes, you may first try this solution by scanning the **Enter Setup** barcode and then **Enable GM** barcode.



@SETUPE0
**** Exit Setup**



@SETUPE1
Enter Setup

Set Length Range for GM

The scanner can be configured to only decode GM barcodes with lengths that fall between (inclusive) the minimum and maximum lengths. To accomplish it, you need to set the minimum and maximum lengths.



@GMCMIN
Set the Minimum Length



@GMC MAX
Set the Maximum Length



Minimum length is not allowed to be greater than maximum length. If you only want to read GM barcodes with a specific length, set both minimum and maximum lengths to be that desired length.



Set the scanner to decode GM barcodes containing between 8 and 12 characters:

1. Scan the **Enter Setup** barcode.
2. Scan the **Set the Minimum Length** barcode.
3. Scan the numeric barcode “8” from the “Digit Barcodes” section in Appendix.
4. Scan the **Save** barcode from the “Save/Cancel Barcodes” section in Appendix.
5. Scan the **Set the Maximum Length** barcode.
6. Scan the numeric barcodes “1” and “2” from the “Digit Barcodes” section in Appendix.
7. Scan the **Save** barcode from the “Save/Cancel Barcodes” section in Appendix.
8. Scan the **Exit Setup** barcode.



@SETUPE0
**** Exit Setup**



@SETUPE1
Enter Setup

Code One

Restore Factory Defaults



@ONEDEF
Restore the Factory Defaults of Code One

Enable/Disable Code One



@ONEENA1
Enable Code One



@ONEENA0
Disable Code One



If the scanner fails to identify Code One barcodes, you may first try this solution by scanning the **Enter Setup** barcode and then **Enable Code One** barcode.



@SETUPE0
**** Exit Setup**



@SETUPE1
Enter Setup

Set Length Range for Code One

The scanner can be configured to only decode Code One barcodes with lengths that fall between (inclusive) the minimum and maximum lengths. To accomplish it, you need to set the minimum and maximum lengths.



@ONEMIN
Set the Minimum Length



@ONEMAX
Set the Maximum Length



Minimum length is not allowed to be greater than maximum length. If you only want to read Code One barcodes with a specific length, set both minimum and maximum lengths to be that desired length.



Set the scanner to decode Code One barcodes containing between 8 and 12 characters:

1. Scan the **Enter Setup** barcode.
2. Scan the **Set the Minimum Length** barcode.
3. Scan the numeric barcode “8” from the “Digit Barcodes” section in Appendix.
4. Scan the **Save** barcode from the “Save/Cancel Barcodes” section in Appendix.
5. Scan the **Set the Maximum Length** barcode.
6. Scan the numeric barcodes “1” and “2” from the “Digit Barcodes” section in Appendix.
7. Scan the **Save** barcode from the “Save/Cancel Barcodes” section in Appendix.
8. Scan the **Exit Setup** barcode.



@SETUPE0
**** Exit Setup**



@SETUPE1
Enter Setup

USPS Postnet

Restore Factory Defaults



@PNTDEF
Restore the Factory Defaults of USPS Postnet

Enable/Disable USPS Postnet



@PNTENA1
Enable USPS Postnet



@PNTENA0
Disable USPS Postnet



If the scanner fails to identify USPS Postnet barcodes, you may first try this solution by scanning the **Enter Setup** barcode and then **Enable USPS Postnet** barcode.

Transmit Check Character



@PNTCHK1
Do Not Transmit USPS Postnet Check Character



@PNTCHK2
Transmit USPS Postnet Check Character



@SETUPE0
** Exit Setup



@SETUPE1
Enter Setup

USPS Intelligent Mail

Restore Factory Defaults



@ILGDEF
Restore the Factory Defaults of USPS Intelligent Mail

Enable/Disable USPS Intelligent Mail



@ILGENA1
Enable USPS Intelligent Mail



@ILGENA0
Disable USPS Intelligent Mail



If the scanner fails to identify USPS Intelligent Mail barcodes, you may first try this solution by scanning the **Enter Setup** barcode and then **Enable USPS Intelligent Mail** barcode.



@SETUPE0
**** Exit Setup**



@SETUPE1
Enter Setup

Royal Mail

Restore Factory Defaults



@ROYDEF
Restore the Factory Defaults of Royal Mail

Enable/Disable Royal Mail



@ROYENA1
Enable Royal Mail



@ROYENA0
Disable Royal Mail



If the scanner fails to identify Royal Mail barcodes, you may first try this solution by scanning the **Enter Setup** barcode and then **Enable Royal Mail** barcode.



@SETUPE0
**** Exit Setup**



@SETUPE1
Enter Setup

USPS Planet

Restore Factory Defaults



@PLADEF
Restore the Factory Defaults of USPS Planet

Enable/Disable USPS Planet



@PLAENA1
Enable USPS Planet



@PLAENA0
Disable USPS Planet



If the scanner fails to identify USPS Planet barcodes, you may first try this solution by scanning the **Enter Setup** barcode and then **Enable USPS Planet** barcode.

Transmit Check Character



@PLACHK1
Do Not Transmit USPS Planet Check Character

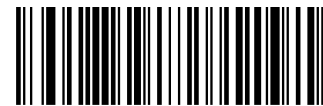

@PLACHK2
Transmit USPS Planet Check Character



@SETUPE0
** Exit Setup



@SETUPE1
Enter Setup

KIX Post

Restore Factory Defaults



@KIXDEF
Restore the Factory Defaults of KIX Post

Enable/Disable KIX Post



@KIXENA1
Enable KIX Post



@KIXENA0
Disable KIX Post



If the scanner fails to identify KIX Post barcodes, you may first try this solution by scanning the **Enter Setup** barcode and then **Enable KIX Post** barcode.



@SETUPE0
**** Exit Setup**



@SETUPE1
Enter Setup

Australian Postal

Restore Factory Defaults



@APLDEF

Restore the Factory Defaults of Australian Postal

Enable/Disable Australian Postal



@APLENA1

Enable Australian Postal



@APLENA0

Disable Australian Postal



If the scanner fails to identify Australian Postal barcodes, you may first try this solution by scanning the **Enter Setup** barcode and then **Enable Australian Postal** barcode.

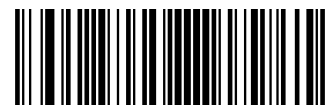

@SETUPE0
**** Exit Setup**



@SETUPE1
Enter Setup

Japan Post

Restore Factory Defaults



@JPPDEF
Restore the Factory Defaults of Japan Post

Enable/Disable Japan Post

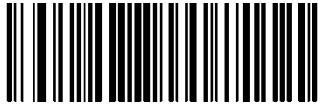

@JPPENA1
Enable Japan Post



@JPPENA1
Disable Japan Post



If the scanner fails to identify Japan Post barcodes, you may first try this solution by scanning the **Enter Setup** barcode and then **Enable Japan Post** barcode.



@SETUPE0
** Exit Setup



@SETUPE1
Enter Setup

Chinese ID Card OCR

Restore Factory Defaults



@IDCDEF

Restore the Factory Defaults of Chinese ID Card OCR

Enable/Disable Chinese ID Card OCR

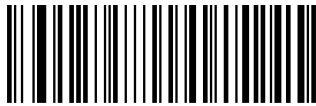

@IDCENA1

Enable Chinese ID Card OCR



@IDCENA0

Disable Chinese ID Card OCR



If the scanner fails to identify Chinese ID Card OCR barcodes, you may first try this solution by scanning the **Enter Setup** barcode and then **Enable Chinese ID Card OCR** barcode.

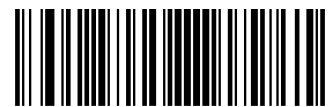

@SETUPE0
**** Exit Setup**



@SETUPE1
Enter Setup

Passport OCR

Restore Factory Defaults



@PASDEF
Restore the Factory Defaults of Passport OCR

Enable/Disable Passport OCR

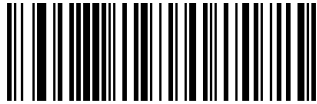

@PASENA1
Enable Passport OCR



@PASENA0
Disable Passport OCR



If the scanner fails to identify Passport OCR barcodes, you may first try this solution by scanning the **Enter Setup** barcode and then **Enable Passport OCR** barcode.



@SETUPE0
** Exit Setup



@SETUPE1
Enter Setup

China Travel Permit OCR

Restore Factory Defaults



@CTPDEF

Restore the Factory Defaults of China Travel Permit OCR

Enable/Disable China Travel Permit OCR



@CTPENAI

Enable China Travel Permit OCR



@CTPENAO

Disable China Travel Permit OCR



If the scanner fails to identify China Travel Permit OCR barcodes, you may first try this solution by scanning the **Enter Setup** barcode and then **Enable China Travel Permit OCR** barcode.

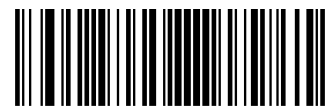

@SETUPE0
**** Exit Setup**



@SETUPE1
Enter Setup

Chapter 10 Data Formatter

Introduction

You may use the Data Formatter to modify the scanner's output. For example, you can use the Data Formatter to insert characters at certain points in barcode data or to suppress/ replace/ send certain characters in barcode data as it is scanned.

Normally, when you scan a barcode, it gets outputted automatically; however, when you create a format, you must use a "send" command (see the "Send Commands" section in this chapter) within the format programming to output data. Multiple data formats can be programmed into the scanner. The maximum size of all data formats created is 2048 characters. By default, the data formatter is disabled. Enable it when required. If you have changed data format settings, and wish to clear all formats and return to the factory defaults, scan the **Default Data Format** code below.



@DFMDEF
Default Data Format

Add a Data Format

Data format is used to edit barcode data. When you create a data format, you must select one of the four labels (Format_0, Format_1, Format_2 and Format_3) for your data format, specify the application scope of data format (such as barcode type and data length) and include formatter commands. Multiple data formats may be created using the same label. When scanned data does not match your data format requirements, you will hear the non-match error beep (if the non-match error beep is ON).

There are two methods to program a data format: Programming with barcodes and programming with serial commands.

Programming with Barcodes

The following explains how to program a data format by scanning the specific barcodes. Scanning any irrelevant barcode or failing to follow the setting procedure will result in programming failure. To find the alphanumeric barcodes needed to create a data format, see the "Digit Barcodes" section in Appendix.

Step 1: Scan the **Enter Setup** barcode.



@SETUPE0
** Exit Setup



@SETUPE1
Enter Setup

Step 2: Scan the **Add Data Format** barcode.



@DFMADD
Add Data Format

Step 3: Select a label (Format_0 or Format_1 or Format_2 or Format_3).

Scan a numeric barcode **0** or **1** or **2** or **3** to label this data format Format_0 or Format_1 or Format_2 or Format_3.

Step 4: Select formatter command type.

Specify what type of formatter commands will be used. Scan a numeric barcode **6** to select formatter command type 6. (See the “Formatter Command Type 6” section in this chapter for more information)

Step 5: Set interface type

Scan **999** for any interface type.

Step 6: Set Symbology ID Number

Refer to the “Symbology ID Number” section in Appendix and find the ID number of the symbology to which you want to apply the data format. Scan three numeric barcodes for the symbology ID number. If you wish to create a data format for all symbologies, scan **999**.

Step 7: Set barcode data length

Specify what length of data will be acceptable for this symbology. Scan the four numeric barcodes that represent the data length. 9999 is a universal number, indicating all lengths. For example, 32 characters should be entered as 0032.

Step 8: Enter formatter command

Refer to the “Formatter Command Type 6” section in this chapter. Scan the alphanumeric barcodes that represent the command you need to edit data. For example, when a command is F141, you should scan F141.

Step 9: Scan the **Save** barcode from the “Save/Cancel Barcodes” section in Appendix to save your data format.



@SETUPE0
**** Exit Setup**



@SETUPE1
Enter Setup

Example: Program a Format_0 data format using formatter command type 6, Code 128 containing 10 characters applicable, send all characters followed by "A".

- | | |
|---|---|
| 1. Scan the Enter Setup barcode | Enter the Setup mode |
| 2. Scan the Add Data Format barcode | Add a data format |
| 3. Scan the 0 barcode | Select Format_0 as the label |
| 4. Scan the 6 barcode | Select formatter command type 6 |
| 5. Scan the 9 barcode three times | All interface types applicable |
| 6. Scan the barcodes 002 | Only Code 128 applicable |
| 7. Scan the barcodes 0010 | Only a length of 10 characters applicable |
| 8. Scan the alphanumeric barcodes F141 | Send all characters followed by "A" (HEX: 41) |
| 9. Scan the Save barcode | Save the data format |

To streamline the programming process, you may as well generate a batch barcode by inputting the command (e.g. **@DFMADD069990020010F141;**) used to create a data format. See the "Use Batch Barcode" section in Chapter 9 to learn how to put a batch barcode into use.

When creating multiple data formats sharing a label, the formats are separated from each other by a vertical bar (|) in the batch command, e.g. **@DFMADD069990029999F141|069990039999F142|169990049999F143;**.



@SETUPE0
**** Exit Setup**



@SETUPE1
Enter Setup

Programming with Serial Commands

A data format can also be created by serial commands (HEX) sent from the host device. **All commands must be entered in uppercase letters.**

The syntax consists of the following elements:

Prefix: “~<SOH>0000” (HEX: **7E 01 30 30 30 30**), 6 characters.

Storage type: “@” (HEX: **40**) or “#” (HEX: **23**), 1 character. “@” means permanent setting which will not be lost by removing power from the scanner or rebooting it; “#” means temporary setting which will be lost by removing power from the scanner or rebooting it.

Add Data Format Command: “DFMADD” (HEX: **44 46 4D 41 44 44**), 6 characters.

Data format label: “0” (HEX: **30**) or “1” (HEX: **31**) or “2” (HEX: **32**) or “3” (HEX: **33**), 1 character. “0”, “1”, “2” and “3” represent Format_0, Format_1, Format_2 and Format_3 respectively.

Formatter command type: “6” (HEX: **36**), 1 character.

Interface type: “999” (HEX: **39 39 39**), 3 characters.

Symbology ID Number: The ID number of the symbology to which you want to apply the data format, 3 characters. 999 indicates all symbologies.

Data length: The length of data that will be acceptable for this symbology, 4 characters. 9999 indicates all lengths. For example, 32 characters should be entered as 0032.

Formatter commands: The command string used to edit data. For more information, see the “Formatter Command Type 6” section in this chapter.

Suffix: “;<ETX>” (HEX: **3B 03**), 2 characters.

Example: Program a Format_0 data format using formatter command type 6, Code 128 containing 10 characters applicable, send all characters followed by “A”.

Enter: **7E 01 30 30 30 30 40 44 46 4D 41 44 44 30 36 39 39 39 30 30 33 39 39 39 39 46 31 34 31 3B 03**
(~<SOH>0000@DFMADD069990020010F141;<ETX>)

Response: **02 01 30 30 30 30 40 44 46 4D 41 44 44 30 36 39 39 39 30 30 33 39 39 39 39 46 31 34 31 06 3B 03**
(<STX><SOH>0000@DFMADD069990020010F141<ACK>;<ETX>)

When creating multiple data formats sharing a label, the formats are separated from each other by a vertical bar (|) in the serial command.

Example: ~<SOH>0000@DFMADD069990020010F141|069990039999F142|069990049999F143;<ETX>



@SETUPE0
** Exit Setup



@SETUPE1
Enter Setup

Enable/Disable Data Formatter

When Data Formatter is disabled, the data format you have enabled becomes invalid.



@DFMENA0
Disable Data Formatter

You may wish to require the data to conform to a data format you have created. The following settings can be applied to your data format:

Enable Data Formatter, Required, Keep Prefix/Suffix: Scanned data that meets your data format requirements is modified accordingly and gets outputted along with prefixes and suffixes (if prefix and suffix are enabled). Any data that does not match your data format requirements generates an error beep (if Non-Match Error Beep is turned ON) and the data in that barcode is not transmitted.

Enable Data Formatter, Required, Drop Prefix/Suffix: Scanned data that meets your data format requirements is modified accordingly and gets outputted without prefixes and suffixes (even if prefix and suffix are enabled). Any data that does not match your data format requirements generates an error beep (if Non-Match Error Beep is turned ON) and the data in that barcode is not transmitted.

Enable Data Formatter, Not Required, Keep Prefix/Suffix: Scanned data that meets your data format requirements is modified accordingly and gets outputted along with prefixes and suffixes (if prefix and suffix are enabled). Barcode data that does not match your data format requirements is transmitted as read along with prefixes and suffixes (if prefix and suffix are enabled).

Enable Data Formatter, Not Required, Drop Prefix/Suffix: Scanned data that meets your data format requirements is modified accordingly and gets outputted without prefixes and suffixes (even if prefix and suffix are enabled). Barcode data that does not match your data format requirements is transmitted as read along with prefixes and suffixes (if prefix and suffix are enabled).



@SETUPE0
** Exit Setup



@SETUPE1
Enter Setup



@DFMENA1

Enable Data Formatter, Required, Keep Prefix/Suffix



@DFMENA2

Enable Data Formatter, Required, Drop Prefix/Suffix



@DFMENA3

Enable Data Formatter, Not Required, Keep Prefix/Suffix



@DFMENA4

Enable Data Formatter, Not Required, Drop Prefix/Suffix

Non-Match Error Beep

If Non-Match Error Beep is turned ON, the scanner generates an error beep when a barcode is encountered that does not match your required data format.

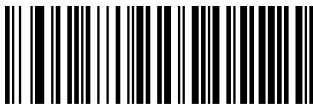

@DFMTON0

Non-Match Error Beep Off



@DFMTON1

Non-Match Error Beep On

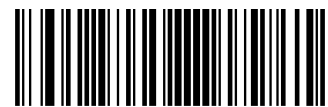

@SETUPE0
** Exit Setup



@SETUPE1
Enter Setup

Data Format Selection

After enabling the Data Formatter, you can select a data format you want to use by scanning the appropriate barcode below.



@DFMUSE0
Format_0



@DFMUSE1
Format_1



@DFMUSE2
Format_2



@DFMUSE3
Format_3



@SETUPE0
**** Exit Setup**



@SETUPE1
Enter Setup

Change Data Format for a Single Scan

You can switch between data formats for a single scan. The next barcode is scanned using the data format selected here, then reverts to the format you have selected above.

For example, you may have set your scanner to use the data format you saved as Format_3. You can switch to Format_1 for a single trigger pull by scanning the **Single Scan – Format_1** barcode below. The next barcode that is scanned uses Format_1, then reverts back to Format_3.

Note: This setting will be lost by removing power from the scanner, or turning off/ rebooting the device.



@DFMSIN0
Single Scan – Format_0



@DFMSIN2
Single Scan – Format_2



@DFMSIN1
Single Scan – Format_1



@DFMSIN3
Single Scan – Format_3

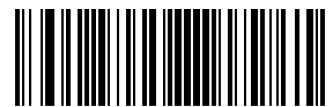

@SETUPE0
**** Exit Setup**



@SETUPE1
Enter Setup

Clear Data Format

There are two methods to remove data format created from your scanner:

Delete one data format: Scan the **Clear One** barcode, a numeric barcode (0-3) and the **Save** barcode. For example, to delete Format_2, you should scan the **Clear One** barcode, the **2** barcode and the **Save** barcode

Delete all data formats: Scan the **Clear All** barcode.

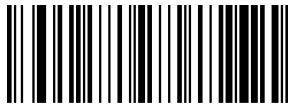

@DFMCAL
Clear All



@DFMCLR
Clear One

Query Data Formats

You may scan the appropriate barcode below to get the information of data format(s) created by you or preset by manufacturer. For instance, if you have added Format_0 as per the example in the “Add a Data Format” section in this chapter, scanning the **Query Current Data Formats** barcode, you will get the result: **Data Format0:069990020010F141;**

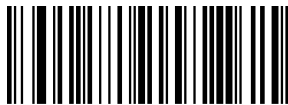

@DFMQCU
Query Current Data Formats



@DFMQFA
Query Preset Data Formats



@SETUPE0
** Exit Setup



@SETUPE1
Enter Setup

Formatter Command Type 6

When working with the Data Formatter, a virtual cursor is moved along your input data string. The following commands are used to both move this cursor to different positions, and to select, replace, and insert data into the final output. For the hex value of ASCII characters involved in the commands, refer to the “ASCII Table” in Appendix.

Send Commands

F1 Send all characters

Syntax=F1xx (xx: The insert character’s hex value)

Include in the output message all of the characters from the input message, starting from current cursor position, followed by an insert character.

F2 Send a number of characters

Syntax=F2nxx (nn: The numeric value (00-99) for the number of characters; xx: The insert character’s hex value)

Include in the output message a number of characters followed by an insert character. Start from the current cursor position and continue for “nn” characters or through the last character in the input message, followed by character “xx.”

F2 Example: Send a number of characters



Send the first 10 characters from the barcode above, followed by a carriage return.

Command string: **F2100D**

F2 is the “Send a number of characters” command

10 is the number of characters to send

0D is the hex value for a CR

The data is output as: **1234567890**

<CR>

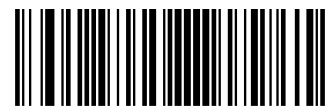

@SETUPE0
** Exit Setup



@SETUPE1
Enter Setup

F3 Send all characters up to a particular character

Syntax=F3ssxx (ss: The particular character's hex value; xx: The insert character's hex value)

Include in the output message all characters from the input message, starting with the character at the current cursor position and continuing to, but not including, the particular character "ss," followed by character "xx." The cursor is moved forward to the "ss" character.

F3 Example: Send all characters up to a particular character



Using the barcode above, send all characters up to but not including "D," followed by a carriage return.

Command string: **F3440D**

F3 is the "Send all characters up to a particular character" command

44 is the hex value for a "D"

0D is the hex value for a CR

The data is output as: **1234567890ABC**

<CR>

E9 Send all but the last characters

Syntax=E9nn (nn: The numeric value (00-99) for the number of characters that will not be sent at the end of the message)

Include in the output message all but the last "nn" characters, starting from the current cursor position. The cursor is moved forward to one position past the last input message character included.

F4 Insert a character multiple times

Syntax=F4xxnn (xx: The insert character's hex value; nn: The numeric value (00-99) for the number of times it should be sent)

Send "xx" character "nn" times in the output message, leaving the cursor in the current position.



@SETUPE0
**** Exit Setup**



@SETUPE1
Enter Setup

E9 and F4 Example: Send all but the last characters, followed by 2 tabs



Send all characters except for the last 8 from the barcode above, followed by 2 tabs.

Command string: **E908F40902**

E9 is the “Send all but the last characters” command

08 is the number of characters at the end to ignore

F4 is the “Insert a character multiple times” command

09 is the hex value for a horizontal tab

02 is the number of time the tab character is sent

The data is output as: **1234567890AB<tab><tab>**

B3 Insert symbology name

Insert the name of the barcode’s symbology in the output message, without moving the cursor.

B4 Insert barcode length

Insert the barcode’s length in the output message, without moving the cursor. The length is expressed as a numeric string and does not include leading zeros.



@SETUPE0
** Exit Setup



@SETUPE1
Enter Setup

B3 and B4 Example: Insert the symbology name and length



Send the symbology name and length before the barcode data from the barcode above. Break up these insertions with spaces. End with a carriage return.

Command string: **B3F42001B4F42001F10D**

B3 is the "Insert symbology name" command

F4 is the "Insert a character multiple times" command

20 is the hex value for a space

01 is the number of time the space character is sent

B4 is the "Insert barcode length" command

F4 is the "Insert a character multiple times" command

20 is the hex value for a space

01 is the number of time the space character is sent

F1 is the "Send all characters" command

0D is the hex value for a CR

The data is output as: **Code128 20 1234567890ABCDEFGHIJ**

<CR>

Move Commands

F5 Move the cursor forward a number of characters

Syntax=F5nn (nn: The numeric value (00-99) for the number of characters the cursor should be moved ahead)

Move the cursor ahead "nn" characters from current cursor position.



@SETUPE0
**** Exit Setup**



@SETUPE1
Enter Setup

F5 Example: Move the cursor forward and send the data



Move the cursor forward 3 characters, then send the rest of the barcode data from the barcode above. End with a carriage return.

Command string: **F503F10D**

F5 is the "Move the cursor forward a number of characters" command

03 is the number of characters to move the cursor

F1 is the "Send all characters" command

0D is the hex value for a CR

The data is output as: **4567890ABCDEFGHIJ**

<CR>

F6 Move the cursor backward a number of characters

Syntax=F6nn (nn: The numeric value (00-99) for the number of characters the cursor should be moved back)

Move the cursor back "nn" characters from current cursor position.

F7 Move the cursor to the beginning

Syntax=F7

Move the cursor to the first character in the input message.

EA Move the cursor to the end

Syntax=EA

Move the cursor to the last character in the input message.



@SETUPE0
** Exit Setup



@SETUPE1
Enter Setup

Search Commands

F8 Search forward for a character

Syntax = F8xx (xx: The search character's hex value)

Search the input message forward for "xx" character from the current cursor position, leaving the cursor pointing to the "xx" character.

F8 Example: Send barcode data that starts after a particular character



Search for the letter "D" in barcodes and send all the data that follows, including the "D". Using the barcode above:

Command string: **F844F10D**

F8 is the "Search forward for a character" command

44 is the hex value for "D"

F1 is the "Send all characters" command

0D is the hex value for a CR

The data is output as: **DEFGHIJ**

<CR>

F9 Search backward for a character

Syntax = F9xx(xx: The search character's hex value)

Search the input message backward for "xx" character from the current cursor position, leaving the cursor pointing to the "xx" character.



@SETUPE0
** Exit Setup



@SETUPE1
Enter Setup

B0 Search forward for a string

Syntax=B0nnnnS (nnnn: The string length (up to 9999); S: The ASCII hex value of each character in the string)

Search forward for “S” string from the current cursor position, leaving cursor pointing to “S” string. For example, B0000454657374 will search forward for the first occurrence of the 4-character string “Test.”

B0 Example: Send barcode data that starts after a string of characters



Search for the letters “FGH” in barcodes and send all the data that follows, including “FGH.” Using the barcode above:

Command string: **B00003464748F10D**

B0 is the “Search forward for a string” command

0003 is the string length (3 characters)

46 is the hex value for “F”

47 is the hex value for “G”

48 is the hex value for “H”

F1 is the “Send all characters” command

0D is the hex value for a CR

The data is output as: **FGHIJ**

<CR>

B1 Search backward for a string

Syntax=B1nnnnS (nnnn: The string length (up to 9999); S: The ASCII hex value of each character in the string)

Search backward for “S” string from the current cursor position, leaving cursor pointing to “S” string. For example, B1000454657374 will search backward for the first occurrence of the 4-character string “Test.”



@SETUPE0
** Exit Setup



@SETUPE1
Enter Setup

E6 Search forward for a non-matching character

Syntax=E6xx (xx: The search character's hex value)

Search the input message forward for the first non-"xx" character from the current cursor position, leaving the cursor pointing to the non-"xx" character.

E6 Example: Remove zeros at the beginning of barcode data



This example shows a barcode that has been zero filled. You may want to ignore the zeros and send all the data that follows. E6 searches forward for the first character that is not zero, then sends all the data after, followed by a carriage return. Using the barcode above:

Command string: **E630F10D**

E6 is the "Search forward for a non-matching character" command

30 is the hex value for 0

F1 is the "Send all characters" command

0D is the hex value for a CR

The data is output as: **37692**

<CR>

E7 Search backward for a non-matching character

Syntax=E7xx(xx: The search character's hex value)

Search the input message backward for the first non-"xx" character from the current cursor position, leaving the cursor pointing to the non-"xx" character.



@SETUPE0
** Exit Setup



@SETUPE1
Enter Setup

Miscellaneous Commands

FB Suppress characters

Syntax = FBnnxyy..zz (nn: The numeric value (00-15) for the number of suppressed characters; xyy..zz: The hex value of the characters to be suppressed)

Suppress all occurrences of up to 15 different characters, starting at the current cursor position, as the cursor is advanced by other commands.

FB Example: Remove spaces in barcode data



This example shows a barcode that has spaces in the data. You may want to remove the spaces before sending the data. Using the barcode above:

Command string: **FB0120F10D**

FB is the “Suppress characters” command

01 is the number of the characters to be suppressed

20 is the hex value for a space

F1 is the “Send all characters” command

0D is the hex value for a CR

The data is output as: **34567890**

<CR>

E4 Replace characters

Syntax = E4nnxx1xx2yy1yy2...zz1zz2(nn: The total count of the number of characters (characters to be replaced plus replacement characters; xx1: The characters to be replaced, xx2: The replacement characters, continuing through zz1 and zz2)

Replace up to 15 characters in the output message, without moving the cursor.



@SETUPE0
** Exit Setup



@SETUPE1
Enter Setup

E4 Example: Replace zeros with CRs in barcode data



If the barcode has characters that the host application does not want included, you can use the E4 command to replace those characters with something else. In this example, you will replace the zeros in the barcode above with carriage returns.

Command string: **E402300DF10D**

E4 is the "Replace characters" command

02 is the total count of characters to be replaced, plus the replacement characters (0 is replaced by CR, so total characters=2)

30 is the hex value for 0

0D is the hex value for a CR (the character that will replace the 0)

F1 is the "Send all characters" command

0D is the hex value for a CR

The data is output as: **1234**

5678

ABC

<CR>



@SETUPE0
**** Exit Setup**



@SETUPE1
Enter Setup

BA Replace a string with another

Syntax = BAnnNN₁SS₁NN₂SS₂

nn: The count of replacements to be made, if nn=00 or nn>=the number of occurrences of a string to be replaced, then replace all occurrences of that string.

NN₁: The length of the string to be replaced, NN₁>0.

SS₁: The ASCII hex value of each character in the string to be replaced.

NN₂: The length of replacement string, NN₂>=0. To replace string "SS₁" with NUL (i.e. delete string "SS₁"), you should set NN₂ to 00 and leave out SS₂.

SS₂: The ASCII hex value of each character in the replacement string.

From the current cursor position, search forward for the occurrence of "SS₁" string (of length "NN₁") and replace the string with "SS₂" string (of length "NN₂") in the output message until every "SS₁" string is replaced or the count of replacements made reaches "nn" times, without moving the cursor.

BA Example: Replace "23"s with "ABC"s in barcode data



cd123abc23bc12ab232

If the barcode has a string of characters that the host application does not want included, you can use the BA command to replace the string with something else. In this example, you will replace the "23"s in the barcode above with "ABC"s.

Command string: **BA0002323303414243F100**

BA is the "Replace a string with another" command

00 is the count of replacements to be made, 00 means to replace all occurrences of that string

02 is the length of the string to be replaced



@SETUPE0
** Exit Setup



@SETUPE1
Enter Setup

32 is the hex value for 2 (character in the string to be replaced)

33 is the hex value for 3 (character in the string to be replaced)

03 is the length of the replacement string

41 is the hex value for A (character in the replacement string)

42 is the hex value for B (character in the replacement string)

43 is the hex value for C (character in the replacement string)

F1 is the "Send all characters" command

00 is the hex value for a NUL

The data is output as: **cd1ABCabcABCbc12abABC2**

BA Example: Remove only the first occurrence of "23"s in barcode data

If the barcode has a string of characters that the host application wants removed, you can use the BA command to replace the string with NUL. In this example, you will remove the first occurrence of "23" in the barcode above.

Command string: **BA0102323300F100**

BA is the "Replace a string with another" command

01 is the count of replacements to be made

02 is the length of the string to be replaced

32 is the hex value for 2 (character in the string to be replaced)

33 is the hex value for 3 (character in the string to be replaced)

00 is the length of the replacement string, 00 means to replace the string to be replaced with NUL

F1 is the "Send all characters" command

00 is the hex value for a NUL

The data is output as: **cd1abc23bc12ab232**



@SETUPE0
**** Exit Setup**



@SETUPE1
Enter Setup

EF Insert a delay

Syntax = EFnnnn (nnnn: The delay in 5ms increments, up to 9999)

Inserts a delay of up to 49,995 milliseconds (in multiples of 5), starting from the current cursor position. This command can only be used with USB HID Keyboard.

EF Example: Insert a delay of 1s between the 5th and 6th character

Send the first 5 characters in a barcode, wait for 1s, then send the rest of the barcode data.

Command string: **F20500EF0200E900**

F2 is the "Send a number of characters" command

05 is the number of characters to send

00 is the hex value for a Null character

EF is the "Insert a delay" command

0200 is the delay value (5msX200=1000ms=1s)

E9 is the "Send all but the last characters" command

00 is the number of characters that will not be sent at the end of the message



@SETUPE0
** Exit Setup



@SETUPE1
Enter Setup

B5 Insert key strokes

Syntax=B5nnssxx (nn: The number of keys pressed (without key modifiers); ss: the key modifier from the table below; xx: the key number from the “Unicode Key Maps” in Appendix.)

Insert a key stroke or combination of key strokes. Key strokes are dependent on your keyboard (see the “Unicode Key Maps” in Appendix). This command can only be used with USB HID Keyboard.

| Key Modifiers | |
|-----------------|----|
| No Key Modifier | 00 |
| Shift Left | 01 |
| Shift Right | 02 |
| Alt Left | 04 |
| Alt Right | 08 |
| Control Left | 10 |
| Control Right | 20 |

For example, B501001F inserts an “a” on a U.S. style keyboard. B5 = the command, 01 = number of keys pressed (without the key modifier), 00 is No Key Modifier, and 1F is the “a” key. If an “A” were to be inserted, B501011F or B501021F would be entered.

If there are two keystrokes, the syntax would change from Syntax=B5nnssxx for one keystroke to Syntax=B5nnssxxsxx. An example that would insert “aA” is as follows: B502001F011F.

Note: Key modifiers can be added together when needed. Example: Shift Left + Alt Left + Control Left =15.



@SETUPE0
** Exit Setup



@SETUPE1
Enter Setup

Chapter 11 Prefix & Suffix

Introduction

A 1D barcode could contain digits, letters, symbols, etc. A 2D barcode could contain more data, such as Chinese characters and other multi-byte characters. However, in real applications, they do not and should not have all information we need, such as barcode type, data acquisition time and delimiter, in order to keep the barcodes short and flexible.

Prefix and suffix are how to fulfill the needs mentioned above. They can be added, removed and modified while the original barcode data remains intact.



Barcode processing procedure:

1. Edit data with Data Formatter
2. Append prefix/suffix
3. Pack data
4. Append terminating character

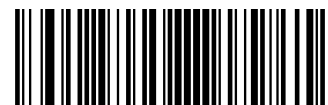

@SETUPE0
** Exit Setup



@SETUPE1
Enter Setup

Global Settings

Enable/Disable All Prefixes/Suffixes

Disable All Prefixes/Suffixes: Transmit barcode data with no prefix/suffix.

Enable All Prefixes/Suffixes: Allow to append Code ID prefix, AIM ID prefix, custom prefix/suffix and terminating character to the barcode data before the transmission.



@APSENA0
Disable All Prefixes/Suffixes



@APSENA1
Enable All Prefixes/Suffixes

Prefix Sequence



@PRESEQ0
Code ID+ Custom +AIM ID



@PRESEQ1
Custom + Code ID + AIM ID



@SETUPE0
** Exit Setup



@SETUPE1
Enter Setup

Custom Prefix

Enable/Disable Custom Prefix

If custom prefix is enabled, you are allowed to append to the data a user-defined prefix that cannot exceed 10 characters. For example, if the custom prefix is “AB” and the barcode data is “123”, the Host will receive “AB123”.



@CPRENA0
Disable Custom Prefix



@CPRENA1
Enable Custom Prefix

Set Custom Prefix

To set a custom prefix, scan the **Set Custom Prefix** barcode then the numeric barcodes corresponding to the hexadecimal value of a desired prefix then the **Save** barcode.

Note: A custom prefix cannot exceed 10 characters.



@CPRSET
Set Custom Prefix



Set the custom prefix to “CODE” (HEX: 0x43/0x4F/0x44/0x45):

1. Scan the **Enter Setup** barcode.
2. Scan the **Set Custom Prefix** barcode.
3. Scan the numeric barcodes “4”, “3”, “4”, “F”, “4”, “4”, “4” and “5” from the “Digit Barcodes” section in Appendix.
4. Scan the **Save** barcode from the “Save/Cancel Barcodes” section in Appendix.
5. Scan the **Enable Custom Prefix** barcode.
6. Scan the **Exit Setup** barcode.



@SETUPE0
** Exit Setup



@SETUPE1

Enter Setup

AIM ID Prefix

AIM (Automatic Identification Manufacturers) ID defines symbology identifier (For the details, see the “AIM ID Table” section in Appendix). If AIM ID prefix is enabled, the scanner will add the symbology identifier before the scanned data after decoding.



@AIDENA0

Disable AIM ID Prefix



@AIDENA1

Enable AIM ID Prefix



AIM ID is not user programmable.



@SETUPE0

**** Exit Setup**



@SETUPE1
Enter Setup

Code ID Prefix

Code ID can also be used to identify barcode type. Unlike AIM ID, Code ID is user programmable. Code ID can only consist of one or two English letters.



@CIDENA0
Disable Code ID Prefix



@CIDENA1
Enable Code ID Prefix

Restore All Default Code IDs

For the information of default Code IDs, see the “Code ID Table” section in Appendix.



@CIDDEF
Restore All Default Code IDs



@SETUPE0
**** Exit Setup**



@SETUPE1
Enter Setup

Modify Code ID

See the examples below to learn how to modify a Code ID and restore the default Code IDs of all symbologies.



Modify PDF417 Code ID to be “p” (HEX: 0x70):

1. Scan the **Enter Setup** barcode.
2. Scan the **Modify PDF417 Code ID** barcode.
3. Scan the numeric barcodes “7” and “0” from the “Digit Barcodes” section in Appendix.
4. Scan the **Save** barcode from the “Save/Cancel Barcodes” section in Appendix.
5. Scan the **Exit Setup** barcode.

Restore the default Code IDs of all symbologies:

1. Scan the **Enter Setup** barcode.
2. Scan the **Restore All Default Code IDs** barcode.
3. Scan the **Exit Setup** barcode.



@SETUPE0
**** Exit Setup**



@SETUPE1
Enter Setup

1D symbologies:



@CID002
Modify Code 128 Code ID



@CID003
Modify GS1-128 Code ID



@CID004
Modify EAN-8 Code ID



@CID005
Modify EAN-13 Code ID



@CID006
Modify UPC-E Code ID



@CID007
Modify UPC-A Code ID



@CID008
Modify Interleaved 2 of 5 Code ID



@SETUPE0
**** Exit Setup**



@SETUPE1
Enter Setup



@CID009
Modify ITF-14 Code ID



@CID010
Modify ITF-6 Code ID



@CID011
Modify Matrix 2 of 5 Code ID



@CID013
Modify Code 39 Code ID



@CID015
Modify Codabar Code ID



@CID017
Modify Code 93 Code ID



@CID019
Modify China Post 25 Code ID



@CID020
Modify AIM 128 Code ID



@SETUPE0
**** Exit Setup**



@SETUPE1

Enter Setup



@CID021

Modify ISBT 128 Code ID



@CID023

Modify ISSN Code ID



@CID024

Modify ISBN Code ID



@CID025

Modify Industrial 25 Code ID



@CID026

Modify Standard 25 Code ID



@CID027

Modify Plessey Code ID



@CID028

Modify Code 11 Code ID



@CID029

Modify MSI-Plessey Code ID



@SETUPE0

**** Exit Setup**



@SETUPE1

Enter Setup



@CID030

Modify GS1 Composite Code ID



@CID031

Modify GS1 Databar Code ID



@CID132

Modify Code 49 Code ID



@CID133

Modify Code 16K Code ID



@SETUPE0

**** Exit Setup**



@SETUPE1
Enter Setup

2D symbologies:



@CID032
Modify PDF417 Code ID



@CID034
Modify Aztec Code ID



@CID039
Modify Chinese Sensible Code ID



@CID042
Modify Micro PDF417 Code ID



@CID033
Modify QR Code ID



@CID035
Modify Data Matrix Code ID



@CID041
Modify GM Code ID

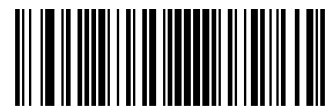

@SETUPE0
**** Exit Setup**



@SETUPE1

Enter Setup



@CID043

Modify Micro QR Code ID



@CID048

Modify Code One Code ID



@SETUPE0

**** Exit Setup**



@SETUPE1

Enter Setup

Postal symbologies:



@CID096

Modify USPS Postnet Code ID



@CID097

Modify USPS Intelligent Mail Code ID



@CID098

Modify Royal Mail Code ID



@CID099

Modify USPS Planet Code ID



@CID100

Modify KIX Post Code ID



@CID101

Modify Australian Postal Code ID



@CID102

Modify Japan Post Code ID



@SETUPE0

**** Exit Setup**



@SETUPE1

Enter Setup

OCR:



@CID065

Modify Chinese ID Card OCR Code ID



@CID066

Modify Passport OCR Code ID



@CID068

Modify China Travel Permit OCR Code ID



@SETUPE0

**** Exit Setup**



@SETUPE1
Enter Setup

Custom Suffix

Enable/Disable Custom Suffix

If custom suffix is enabled, you are allowed to append to the data a user-defined suffix that cannot exceed 10 characters. For example, if the custom suffix is “AB” and the barcode data is “123”, the Host will receive “123AB”.



@CSUENA0
Disable Custom Suffix



@CSUENA1
Enable Custom Suffix

Set Custom Suffix

To set a custom suffix, scan the **Set Custom Suffix** barcode then the numeric barcodes corresponding to the hexadecimal value of a desired suffix then the **Save** barcode.

Note: A custom suffix cannot exceed 10 characters.



@CSUSET
Set Custom Suffix



Set the custom suffix to “CODE” (HEX: 0x43/0x4F/0x44/0x45):

1. Scan the **Enter Setup** barcode.
2. Scan the **Set Custom Suffix** barcode.
3. Scan the numeric barcodes “4”, “3”, “4”, “F”, “4”, “4”, “4” and “5” from the “Digit Barcodes” section in Appendix.
4. Scan the **Save** barcode from the “Save/Cancel Barcodes” section in Appendix.
5. Scan the **Enable Custom Suffix** barcode.
6. Scan the **Exit Setup** barcode.



@SETUPE0
** Exit Setup



@SETUPE1
Enter Setup

Data Packing

Introduction

Data packing is designed for a specific group of users who want to have the data packed before transmission. Data packing influences data format, so it is advised to disable this feature when it is not required.

Data Packing Options

- ✧ **Disable Data Packing:** Transmit decoded data in raw format (unpacked).
- ✧ **Enable Data Packing, Format 1:** Transmit decoded data with the packet format 1 defined below.
Packet format 1: [STX + ATTR + LEN] + [AL_TYPE + DATA] + [LRC]
STX: 0x02
ATTR: 0x00
LEN: Barcode data length is expressed in 2 bytes ranging from 0x0000 (0) to 0xFFFF (65535).
AL_TYPE: 0x36
DATA: Raw barcode data.
LRC: Check digit.
LRC calculation algorithm: computation sequence: 0xFF+LEN+AL_TYPE+DATA; computation method is XOR, byte by byte.
- ✧ **Enable Data Packing, Format 2:** Transmit decoded data with the packet format 2 defined below.
Packet format 2: [STX + ATTR + LEN] + [AL_TYPE] + [Symbology_ID + DATA] + [LRC]
STX: 0x02
ATTR: 0x00
LEN: Barcode data length is expressed in 2 bytes ranging from 0x0000 (0) to 0xFFFF (65535).
AL_TYPE: 0x3B
Symbology_ID: The ID number of symbology, 1 byte.
DATA: Raw barcode data.
LRC: Check digit.
LRC calculation algorithm: computation sequence: 0xFF+LEN+AL_TYPE+Symbology_ID+DATA; computation method is XOR, byte by byte.



@SETUPE0
** Exit Setup



@SETUPE1
Enter Setup



@PACKAG0
Disable Data Packing



@PACKAG1
Enable Data Packing, Format 1

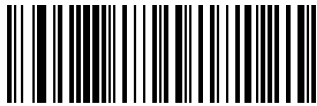

@PACKAG2
Enable Data Packing, Format 2

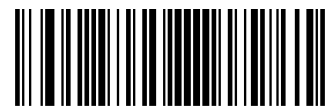

@SETUPE0
**** Exit Setup**



@SETUPE1
Enter Setup

Terminating Character Suffix

Enable/Disable Terminating Character Suffix

A terminating character such as carriage return (CR) or carriage return/line feed pair (CRLF) can only be used to mark the end of data, which means nothing can be added after it.



@TSUENA0
Disable Terminating Character Suffix



@TSUENA1
Enable Terminating Character Suffix

Set Terminating Character Suffix

To set a terminating character suffix, scan the **Set Terminating Character Suffix** barcode then the numeric barcodes corresponding to the hexadecimal value of a desired terminating character then the **Save** barcode.

Note: A terminating character suffix cannot exceed 2 characters.



@TSUSET
Set Terminating Character Suffix



@TSUSET0D
Set Terminating Character to CR (0x0D)



@TSUSET0D0A
Set Terminating Character to CRLF (0x0D,0x0A)



@SETUPE0
** Exit Setup



@SETUPE1
Enter Setup



Set the terminating character suffix to 0x0A:

1. Scan the **Enter Setup** barcode.
2. Scan the **Set Terminating Character Suffix** barcode.
3. Scan the numeric barcodes "0" and "A" from the "Digit Barcodes" section in Appendix.
4. Scan the **Save** barcode from the "Save/Cancel Barcodes" section in Appendix.
5. Scan the **Enable Terminating Character Suffix** barcode.
6. Scan the **Exit Setup** barcode.

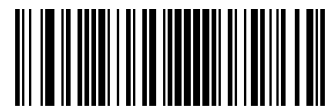

@SETUPE0
**** Exit Setup**



@SETUPE1
Enter Setup

Chapter 12 Programming Commands

Use of Programming Command

Besides the barcode programming method, the scanner can also be configured by serial commands (HEX) sent from the host device. **All commands must be entered in uppercase letters.**

Query Commands

For query commands, the entry in the **Data** field in the syntax above is one of the following characters means:

* (HEX: **2A**) What is the scanner's current value for the setting(s).

& (HEX: **26**) What is the factory default value for the setting(s).

^ (HEX: **5E**) What is the range of possible values for the setting(s).

The value of the **StoreType** field in a query command can be either "@" (HEX: **40**) or "#" (HEX: **23**).

A query command with the **SubTag** field omitted means to query all the settings concerning a tag. For example, to query all the current settings about Code 11, you should enter **7E 01 30 30 30 30 40 43 31 31 2A 3B 03** (i.e. ~<SOH>0000@C11*;<ETX>).

Command Syntax

Prefix StorageType Tag SubTag {Data} [,SubTag {Data}] [:Tag SubTag {Data}] [...] Suffix

Prefix: "~<SOH>0000" (HEX: **7E 01 30 30 30 30**), 6 characters.

StorageType: "@" (HEX: **40**) or "#" (HEX: **23**), 1 character. "@" means permanent setting which will not be lost by removing power from the scanner or rebooting it; "#" means temporary setting which will be lost by removing power from the scanner or rebooting it.

Tag: A 3-character case-sensitive field that identifies the desired command group. For example, all USB HID Keyboard configuration settings are identified with a Tag of KBW.

SubTag: A 3-character case-sensitive field that identifies the desired parameter within the tag group. For example, the SubTag for the keyboard layout is CTY.

Data: The value for a feature or parameter setting, identified by the Tag and SubTag.

Suffix: ";<ETX>" (HEX: **3B 03**), 2 characters.



@SETUPE0
** Exit Setup



@SETUPE1

Enter Setup

Multiple commands can be issued within one Prefix/Suffix sequence. For configuration commands, only the **Tag**, **SubTag**, and **Data** fields must be repeated for each command in sequence. If an additional command is to be applied to the same Tag, then the command is separated with a comma (,) and only the **SubTag** and **Data** fields of the additional commands are issued. If the additional command requires a different **Tag** field, the command is separated from previous command by a semicolon (;).

Responses

Different from command sequence, the prefix of a response consists of the six characters of “<STX><SOH>0000” (HEX: **02 01 30 30 30 30**).

The scanner responds to serial commands with one of the following three responses:

- <ACK> (HEX: **06**) Indicates a good command which has been processed.
- <NAK> (HEX: **15**) Indicates a good configuration command with its **Data** field entry out of the allowable range for this Tag and SubTag combination (e.g. an entry for an inter-keystroke delay of 100 when the field will only allow 2 digits), or an invalid query command.
- <ENQ> (HEX: **05**) Indicates an invalid Tag or SubTag command.

When responding, the scanner echoes back the command sequence with the status character above inserted directly before each of the punctuation marks (the comma or semicolon) in the command.

Examples

Example 1: Enable Code 11, set the minimum and maximum lengths to 12 and 22 respectively.

Enter: **7E 01 30 30 30 30 40 43 31 31 45 4E 41 31 2C 4D 49 4E 31 32 2C 4D 41 58 32 32 3B 03**
(~<SOH>0000@C11ENA1,MIFM32802,MAX22;<ETX>)

Response: **02 01 30 30 30 30 40 43 31 31 45 4E 41 31 06 2C 4D 49 4E 31 32 06 2C 4D 41 58 32 32 06 3B 03**
(<STX><SOH>0000@C11ENA1<ACK>,MIFM32802<ACK>,MAX22<ACK>;<ETX>)

Example 2: Query the current minimum and maximum lengths of Code 11.

Enter: **7E 01 30 30 30 30 40 43 31 31 4D 49 4E 2A 2C 4D 41 58 2A 3B 03**
(~<SOH>0000@C11MIN*,MAX*;<ETX>)

Response: **02 01 30 30 30 30 40 43 31 31 4D 49 4E 31 32 06 2C 4D 41 58 32 32 06 3B 03**
(<STX><SOH>0000@C11MIFM32802<ACK>,MAX22<ACK>;<ETX>)



@SETUPE0

** Exit Setup



@SETUPE1

Enter Setup

Read Barcode On/Off

Sending the Read Barcode Off command `~<SOH>0000#SCNENA0;<ETX>` to the scanner can disable it from reading barcode, and the scanner is unable to scan barcode unless you send the Read Barcode On command `~<SOH>0000#SCNENA1;<ETX>` to it or power cycle it. By default, Read Barcode is On.

Make a Beeping Sound

You may wish to force the scanner to beep upon a command sent from the host. A beeping sound is made to gain a user's attention to an error or other important event.

BEEPONxxxFyyyTnnV (xxx: The desired frequency, 1-20,000Hz; yyy: The desired duration, 1-10,000ms; nn: The desired volume level, 1-20 (lowest-loudest))

Example: Make a 50ms beep at 2,000Hz with volume level set to 20

Enter: `~<SOH>0000#BEEPON2000F50T20V;<ETX>`

Response: `<STX><SOH>0000#BEEPON2000F50T20V<ACK>;<ETX>`



@SETUPE0

** Exit Setup



@SETUPE1
Enter Setup

Turn On Good Read LED

You may turn on the external Good Read LED of the scanner for a certain period of time with a command sent from the host. Note that the scanner **cannot** scan barcodes when it is executing this command. The duration is from 10 to 10000ms.

Command for querying whether the scanner supports this feature: LEDONS* or LEDONS&

Returning LEDONS<ACK> indicates the scanner supports this feature.

Command for querying the range of possible values for the setting: LEDONS^

Returning LEDONS-2C10-10000D <ACK> indicates the range for the length of time the LED stays lit is 10-10000ms.

Example: Turn on the Good Read LED for 1,000ms

Enter: ~<SOH>0000#LEDONS2C1000D;<ETX>

Response: <STX><SOH>0000#LEDONS2C1000D<ACK>;<ETX>

Turn On Illumination LED

You may turn on the internal illumination LED on the scanner for a certain period of time with a command sent from the host. Note that the scanner **cannot** scan barcodes when it is executing this command. The duration is from 10 to 10000ms.

Command for querying whether the scanner supports this feature: LEDONI* or LEDONI&

Returning LEDONI<ACK> indicates the scanner supports this feature.

Command for querying the range of possible values for the setting: LEDONI^

Returning LEDONI-0C10-10000D <ACK> indicates the range for the length of time the LED stays lit is 10-10000ms.

Example: Turn on the illumination LED for 1,000ms

Enter: ~<SOH>0000#LEDONI0C1000D;<ETX>

Response: <STX><SOH>0000#LEDONI0C1000D<ACK>;<ETX>



@SETUPE0
** Exit Setup



@SETUPE1
Enter Setup

Chapter 13 Batch Programming

Introduction

Batch programming enables users to integrate a batch of commands into a single batch barcode.

Listed below are batch programming rules:

1. Command format: Command + Parameter Value.
2. Each command is terminated by a semicolon (;). Note that there is no space between a command and its terminator semicolon.
3. Use the barcode generator software to generate a 2D batch barcode.

Example: Create a batch barcode for **Illumination Always On, Sense Mode, Decode Session Timeout = 2s**:

1. Input the commands:

@ILLSCN2;SCNMOD2;ORTSET2000;

2. Generate a batch barcode.

When setting up a scanner with the above configuration, scan the **Enable Batch Barcode** barcode and then the batch barcode generated.



@BATCHS
Enable Batch Barcode



@SETUPE0
** Exit Setup



@SETUPE1
Enter Setup

Create a Batch Command

A batch command may contain a number of individual commands each of which is terminated by a semicolon (;).

For more information, refer to the “Use of Programming Command” section in Chapter 3.

Create a Batch Barcode

Batch barcodes can be produced in the format of PDF417, QR Code or Data Matrix.

Example: Create a batch barcode for **Illumination Always On, Sense Mode, Decode Session Timeout = 2s:**

1. Input the following commands:

```
@ILLSCN2;SCNMOD2;ORTSET2000;
```

2. Generate a PDF417 batch barcode.



@SETUPE0
** Exit Setup



@SETUPE1
Enter Setup

Use Batch Barcode

To put a batch barcode into use, scan the following barcodes. (Use the example above.)



@SETUPE1
Enter Setup

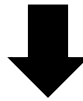

@BATCHS
Enable Batch Barcode



Batch Barcode



@SETUPE0
Exit Setup



@SETUPE0
** Exit Setup

Appendix

Digit Barcodes

0~9



@DIGIT0

0



@DIGIT2

2



@DIGIT4

4



@DIGIT1

1



@DIGIT3

3



@DIGIT5

5



@DIGIT6

6



@DIGIT7

7



@DIGIT8

8



@DIGIT9

9

A~F



@DIGITA

A



@DIGITB

B



@DIGITC

C



@DIGITD

D



@DIGITE

E



@DIGITF

F

Save/Cancel Barcodes

After reading numeric barcode(s), you need to scan the **Save** barcode to save the data. If you scan the wrong digit(s), you can either scan the **Cancel** barcode and then start the configuration all over again, or scan the **Delete the Last Digit** barcode and then the correct digit, or scan the **Delete All Digits** barcode and then the digits you want.

For instance, after reading the **Maximum Length** barcode and numeric barcodes “1”, “2” and “3”, you scan:

- ✧ **Delete the Last Digit:** The last digit “3” will be removed.
- ✧ **Delete All Digits:** All digits “123” will be removed.
- ✧ **Cancel:** The maximum length configuration will be cancelled. And the scanner is still in the setup mode.



@DIGSAV

Save



@DIGCAN

Cancel



@DIGDEL

Delete the Last Digit



@DIGDAL

Delete All Digits

Factory Defaults Table (ST.H01.U2.2)

| Parameter | Factory Default | Remark |
|---|---|----------------------------|
| System Settings | | |
| Barcode Programming | Disabled (Exit Setup) | |
| Programming Barcode Data | Do not transmit | |
| Scan Mode | Sense Mode | |
| Decode Session Timeout | 5000ms | 1-3,600,000ms; 0: Infinite |
| Types of Triggering | Low Level Trigger | |
| Debounce Time | 20ms | |
| Enter the Detection/ Reading State (Sense Mode) | Enter the Detection State | |
| Image Stabilization Timeout (Sense Mode) | 300ms | 0-3,000ms |
| Trigger Selection (Sense Mode) | Image Change Trigger and IR Proximity Trigger | |
| Image Change Trigger Sensitivity | 6 | |
| IR Proximity Trigger Sensitivity | 5 | |
| Illumination During the Detection State | Off | |
| Reread Timeout | Disabled, 1500ms | 1-3,600,000ms |
| Reread Timeout Reset | Off | |
| Good Read Delay | Disabled, 500ms | 1-3,600,000ms |
| Scanning Preference | Screen Mode | |
| Scanning After Power-on | Enabled | |
| Security Level | 1 | |
| Decode Area | Whole Area Decoding | |
| Specify Decoding Area | 40% top, 60% bottom, 40% left, 60% right | |
| Image Flipping | Do Not Flip | |
| Bad Read Message | Off | |
| | 4E47 | 1-7 characters |
| Good Read Signal | Off | |
| Polarity of Good Read Signal | Low Level | |
| Good Read Indicator Duration | 250ms | |
| Trigger Commands | Disabled | |
| Start Scanning Command | <SOH> T <EOT> | |
| Stop Scanning Command | <SOH> P <EOT> | |
| Illumination | Normal | |

| | | |
|---|--------------------------------------|------------------|
| Illumination Brightness | Level 1 | |
| Illumination Color Selection | White | |
| Good Read LED | On | |
| Good Read LED Duration | 220ms | |
| Power On Beep | On | |
| Good Read Beep | On | |
| Good Read Beep Duration | Medium (80ms) | |
| Good Read Beep Frequency | Medium (2730Hz) | |
| Good Read Beep Volume | Loud | |
| NFC Function | Disabled | |
| NFC Card Searching Duration | 200 | |
| Timeout between Decodes (Same NFC Card) | Enabled | |
| | 5000ms | |
| Default Interface | USB HID Keyboard | |
| RS-232 Interface | | |
| Baud Rate | 9600 | |
| Parity Check | None | |
| Data Bits | 8 | |
| Stop Bits | 1 | |
| Hardware Auto Flow Control | Disable | |
| USB Interface | | |
| USB Country Keyboard | US keyboard | USB HID Keyboard |
| Beep on Unknown Character | Off | USB HID Keyboard |
| Emulate ALT+Keypad | Off | USB HID Keyboard |
| Code Page | Code Page 1252 (West European Latin) | USB HID Keyboard |
| Unicode Encoding | Off | USB HID Keyboard |
| Emulate Keypad with Leading Zero | On | USB HID Keyboard |
| Function Key Mapping | Disable | USB HID Keyboard |
| Inter-Keystroke Delay | No Delay | USB HID Keyboard |
| Caps Lock | Caps Lock OFF, non-Japanese Keyboard | USB HID Keyboard |
| Convert Case | No Case Conversion | USB HID Keyboard |
| Emulate Numeric Keypad 1 | Off | USB HID Keyboard |
| Emulate Numeric Keypad 2 | Off | USB HID Keyboard |
| Fast Mode | Off | USB HID Keyboard |
| Polling Rate | 1ms | USB HID Keyboard |

| | | |
|--|---|--|
| Adaptive Wired Communication | On | |
| Symbologies | | |
| Global Settings | | |
| 1D Twin Code | Single 1D Code Only | |
| Surround GS1 AI's with Parentheses | Do Not Surround GS1 AI's with Parentheses | |
| Code 128 | | |
| Code 128 | Enabled | |
| Maximum Length | 48 | |
| Minimum Length | 1 | |
| EAN-8 | | |
| EAN-8 | Enabled | |
| Check Character | Transmit | |
| 2-Digit Add-On Code | Disabled | |
| 5-Digit Add-On Code | Disabled | |
| Add-On Code | Not Required | |
| Convert EAN-8 to EAN-13 | Disabled | |
| EAN-13 | | |
| EAN-13 | Enabled | |
| Check Character | Transmit | |
| 2-Digit Add-On Code | Disabled | |
| 5-Digit Add-On Code | Disabled | |
| Add-On Code | Not Required | |
| EAN-13 Beginning with 290 Add-On Code Required | Do Not Require Add-On Code | |
| EAN-13 Beginning with 378/379 Add-On Code Required | Do Not Require Add-On Code | |
| EAN-13 Beginning with 414/419 Add-On Code Required | Do Not Require Add-On Code | |
| EAN-13 Beginning with 434/439 Add-On Code Required | Do Not Require Add-On Code | |
| EAN-13 Beginning with 977 Add-On Code Required | Do Not Require Add-On Code | |
| EAN-13 Beginning with 978 Add-On Code Required | Do Not Require Add-On Code | |
| EAN-13 Beginning with 979 Add-On Code Required | Do Not Require Add-On Code | |
| UPC-E | | |
| UPC-E0 | Enabled | |
| UPC-E1 | Disabled | |

| | | |
|--|------------------|----------------|
| Check Character | Transmit | |
| 2-Digit Add-On Code | Disabled | |
| 5-Digit Add-On Code | Disabled | |
| Add-On Code | Not Required | |
| Transmit Preamble Character | System Character | |
| Extend UPC-E to UPC-A | Disabled | |
| UPC-A | | |
| UPC-A | Enabled | |
| Check Character | Transmit | |
| 2-Digit Add-On Code | Disabled | |
| 5-Digit Add-On Code | Disabled | |
| Add-On Code | Not Required | |
| Transmit Preamble Character | System Character | |
| Coupon | | |
| UPC-A/EAN-13 with Extended Coupon Code | Disabled | |
| Coupon GS1 DataBar Output | Disabled | |
| Interleaved 2 of 5 | | |
| Interleaved 2 of 5 | Enabled | |
| Maximum Length | 80 | |
| Minimum Length | 6 | No less than 4 |
| Check Character Verification | Disabled | |
| Febraban | | |
| Febraban | Disabled | |
| Transmit Delay per Character | Disabled | |
| | 70ms | |
| Transmit Delay per 12 Characters | Disabled | |
| | 500ms | |
| ITF-14 | | |
| ITF-14 | Disabled | |
| ITF-6 | | |
| ITF-6 | Disabled | |
| Matrix 2 of 5 | | |
| Matrix 2 of 5 | Disabled | |
| Maximum Length | 80 | |
| Minimum Length | 4 | No less than 4 |

| | | |
|--------------------------------|-----------------|----------------|
| Check Character Verification | Disabled | |
| Code 39 | | |
| Code 39 | Enabled | |
| Maximum Length | 48 | |
| Minimum Length | 1 | |
| Check Character Verification | Disabled | |
| Start/Stop Character | Do not transmit | |
| Code 39 Full ASCII | Enabled | |
| Code 32 Pharmaceutical (PARAF) | Disabled | |
| Code 32 Prefix | Disabled | |
| Code 32 Start/Stop Character | Do not transmit | |
| Code 32 Check Character | Do not transmit | |
| Codabar | | |
| Codabar | Enabled | |
| Maximum Length | 60 | |
| Minimum Length | 2 | |
| Check Character Verification | Disabled | |
| Start/Stop Character | Do not transmit | |
| | ABCD/ABCD | |
| Code 93 | | |
| Code 93 | Enabled | |
| Maximum Length | 48 | |
| Minimum Length | 1 | No less than 1 |
| China Post 25 | | |
| China Post 25 | Disabled | |
| Maximum Length | 48 | |
| Minimum Length | 1 | |
| Check Character Verification | Disabled | |
| GS1-128 (UCC/EAN-128) | | |
| GS1-128 | Enabled | |
| Maximum Length | 48 | |
| Minimum Length | 1 | |
| GS1 Databar | | |
| GS1 Databar | Enabled | |
| Application Identifier "01" | Transmit | |

| <i>EAN•UCC Composite</i> | | |
|---------------------------------|----------------------------|----------------|
| GS1 Composite | Enabled | |
| UPC/EAN Composite | Disabled | |
| <i>Code 11</i> | | |
| Code 11 | Enabled | |
| Maximum Length | 48 | |
| Minimum Length | 4 | No less than 4 |
| Check Character Verification | One Check Character, MOD11 | |
| Check Character | Do not transmit | |
| <i>ISBN</i> | | |
| ISBN | Enabled | |
| Set ISBN Format | ISBN-10 | |
| <i>ISSN</i> | | |
| ISSN | Disabled | |
| <i>Industrial 25</i> | | |
| Industrial 25 | Enabled | |
| Maximum Length | 48 | |
| Minimum Length | 6 | No less than 4 |
| Check Character Verification | Disabled | |
| <i>Standard 25</i> | | |
| Standard 25 | Enabled | |
| Maximum Length | 48 | |
| Minimum Length | 6 | No less than 4 |
| Check Character Verification | Disabled | |
| <i>Plessey</i> | | |
| Plessey | Enabled | |
| Maximum Length | 48 | |
| Minimum Length | 4 | No less than 4 |
| Check Character Verification | Disable | |
| <i>MSI-Plessey</i> | | |
| MSI-Plessey | Enabled | |
| Maximum Length | 48 | |
| Minimum Length | 4 | No less than 4 |
| Check Character Verification | One Check Character, MOD10 | |
| Check Character | Transmit | |

| AIM 128 | | |
|---------------------|-------------------------------------|--|
| AIM 128 | Enabled | |
| Maximum Length | 48 | |
| Minimum Length | 1 | |
| ISBT 128 | | |
| ISBT 128 | Disabled | |
| Code 49 | | |
| Code 49 | Disabled | |
| Maximum Length | 80 | |
| Minimum Length | 1 | |
| Code 16K | | |
| Code 16K | Disabled | |
| Maximum Length | 80 | |
| Minimum Length | 1 | |
| PDF417 | | |
| PDF417 | Enabled | |
| Maximum Length | 65535 | |
| Minimum Length | 1 | |
| PDF417 Twin Code | Single PDF417 Only | |
| PDF417 Inverse | Decode Regular PDF417 Barcodes Only | |
| Character Encoding | Default Character Encoding | |
| PDF417 ECI Output | Enabled | |
| Micro PDF417 | | |
| Micro PDF417 | Disabled | |
| Maximum Length | 65535 | |
| Minimum Length | 1 | |
| QR Code | | |
| QR Code | Enabled | |
| Maximum Length | 65535 | |
| Minimum Length | 1 | |
| QR Twin Code | Single QR Only | |
| QR Inverse | Decode Regular QR Barcodes Only | |
| Character Encoding | Default Character Encoding | |
| QR ECI Output | Enabled | |
| URL QR | Enabled | |

| Micro QR Code | | |
|---------------------------------|---|--|
| Micro QR | Enabled | |
| Maximum Length | 65535 | |
| Minimum Length | 1 | |
| Aztec | | |
| Aztec Code | Disabled | |
| Maximum Length | 65535 | |
| Minimum Length | 1 | |
| Read Multi-barcodes on an Image | Mode 1 | |
| Character Encoding | Default Character Encoding | |
| Aztec ECI Output | Enabled | |
| Data Matrix | | |
| Data Matrix | Enabled | |
| Maximum Length | 65535 | |
| Minimum Length | 1 | |
| Data Matrix Twin Code | Single Data Matrix Only | |
| Rectangular Barcode | Enabled | |
| Data Matrix Inverse | Decode Regular Data Matrix Barcodes Only | |
| Character Encoding | Default Character Encoding | |
| Data Matrix ECI Output | Enabled | |
| Chinese Sensible Code | | |
| Chinese Sensible Code | Disabled | |
| Maximum Length | 65535 | |
| Minimum Length | 1 | |
| Chinese Sensible Twin Code | Single Chinese Sensible Code Only | |
| Chinese Sensible Code Inverse | Decode Regular Chinese Sensible Barcodes Only | |
| GM Code | | |
| GM | Disabled | |
| Maximum Length | 65535 | |
| Minimum Length | 1 | |
| Code One | | |
| Code One | Disabled | |
| Maximum Length | 65535 | |
| Minimum Length | 1 | |

| | | |
|--------------------------------|-----------------------|--|
| USPS Postnet | | |
| USPS Postnet | Disabled | |
| Check Character | Transmit | |
| USPS Intelligent Mail | | |
| USPS Intelligent Mail | Disabled | |
| Royal Mail | | |
| Royal Mail | Disabled | |
| USPS Planet | | |
| USPS Planet | Disabled | |
| Check Character | Transmit | |
| KIX Post | | |
| KIX Post | Disabled | |
| Australian Postal | | |
| Australian Postal | Disabled | |
| Japan Post | | |
| Japan Post | Disabled | |
| Chinese ID Card OCR | | |
| Chinese ID Card OCR | Disabled | |
| Passport OCR | | |
| Passport OCR | Disabled | |
| China Travel Permit OCR | | |
| China Travel Permit OCR | Disabled | |
| Data Formatter | | |
| Data Formatter | Disabled | |
| Non-Match Error Beep | On | |
| Data Format Selection | Format_0 | |
| Prefix & Suffix | | |
| All Prefixes/Suffixes | Disabled | |
| Prefix Sequence | Code ID+Custom+AIM ID | |
| Custom Prefix | Disabled | |
| AIM ID Prefix | Disabled | |
| Code ID Prefix | Disabled | |
| Custom Suffix | Disabled | |
| Data Packing | Disable Data Packing | |
| Terminating Character Suffix | Enabled (Return) | |

AIM ID Table(V2022.6)

| Symbology | AIM ID | Possible AIM ID Modifiers (m) |
|-----------------------|---------------|-------------------------------|
| Code 128 |]C0 | |
| GS1-128 (UCC/EAN-128) |]C1 | |
| EAN-8 |]E4 | |
| EAN-13 |]E0 | |
| EAN-13 with Addon |]E3 | |
| UPC-E |]E0 | |
| UPC-E with Addon |]E3 | |
| UPC-A |]E0 | |
| UPC-A with Addon |]E3 | |
| Interleaved 2 of 5 |]Im | 0, 1, 3 |
| ITF-14 |]Im | 1, 3 |
| ITF-6 |]Im | 1, 3 |
| Matrix 2 of 5 |]X0 | |
| Code 39 |]Am | 0, 1, 3, 4, 5, 7 |
| Codabar |]Fm | 0, 2, 4 |
| Code 93 |]G0 | |
| China Post 25 |]X0 | |
| AIM 128 |]C2 | |
| ISBT 128 |]C4 | |
| ISSN |]X0 | |
| ISBN |]X0,]E0,]E3 | |
| Industrial 25 |]S0 | |
| Standard 25 |]Rm | 0, 1, 3 |
| Plessey |]P0 | |
| Code 11 |]Hm | 0, 1, 3 |
| MSI Plessey |]Mm | 0, 1 |
| GS1 Composite |]em | 0-3 |
| GS1 Databar(RSS) |]e0 | |
| Code 49 |]Tm | 0, 1, 2, 4 |
| Code 16K |]Km | 0, 1, 2, 4 |
| PDF417 |]Lm | 0-5 |
| QR Code |]Qm | 0-6 |
| Aztec |]zm | 0-9, A-C |

| | | |
|-------------------------|---------------|---------------|
| Coupon |]E0,]e0,]C1 | |
| Data Matrix |]dm | 0-6 |
| Chinese Sensible Code |]hm | 0, 1, 2, 4, 8 |
| GM |]gm | 0-5 |
| Micro PDF417 |]Lm | 1-5 |
| Micro QR |]Qm | 0-6 |
| Code One |]Dm | 0, 1, 2, 4 |
| USPS Postnet |]X0 | |
| USPS Intelligent Mail |]X0 | |
| Royal Mail |]X0 | |
| USPS Planet |]X0 | |
| KIX Post |]X0 | |
| Australian Postal |]X0 | |
| Japan Post |]X0 | |
| Passport OCR |]o2 | |
| Chinese ID Card |]o2 | |
| China Travel Permit OCR |]o2 | |

Code ID Table(V1.00.0)

| Symbology | Code ID |
|------------------------------|---------|
| Code 128 | j |
| GS1-128 (UCC/EAN-128) | j |
| EAN-8 | d |
| EAN-13 | d |
| UPC-E | c |
| UPC-A | c |
| Interleaved 2 of 5, Febraban | e |
| ITF-14 | e |
| ITF-6 | e |
| Matrix 2 of 5 | v |
| Code 39 | b |
| Codabar | a |
| Code 93 | i |
| China Post 25 | X |
| AIM 128 | X |
| ISBT 128 | X |
| ISSN | g |
| ISBN | B |
| Industrial 25 | l |
| Standard 25 | f |
| Plessey | n |
| Code 11 | H |
| MSI Plessey | m |
| GS1 Composite | y |
| GS1 Databar (RSS) | R |
| Code 49 | X |
| Code 16K | X |
| PDF417 | r |
| QR Code | s |
| Aztec | z |
| Data Matrix | u |

| Symbology | Code ID |
|-------------------------|---------|
| Chinese Sensible Code | h |
| GM Code | x |
| Micro PDF417 | R |
| Micro QR | X |
| Code One | X |
| USPS Postnet | P |
| USPS Intelligent Mail | M |
| Royal Mail | x |
| USPS Planet | L |
| KIX Post | K |
| Australian Postal | A |
| Japan Post | J |
| Chinese ID Card OCR | S |
| Passport OCR | O |
| China Travel Permit OCR | S |

Symbology ID Number(V1.00.0)

| Symbology | ID Number |
|------------------------------|-----------|
| Code 128 | 002 |
| GS1-128 (UCC/EAN-128) | 003 |
| EAN-8 | 004 |
| EAN-13 | 005 |
| UPC-E | 006 |
| UPC-A | 007 |
| Interleaved 2 of 5, Febraban | 008 |
| ITF-14 | 009 |
| ITF-6 | 010 |
| Matrix 2 of 5 | 011 |
| Code 39 | 013 |
| Codabar | 015 |
| Code 93 | 017 |
| China Post 25 | 019 |
| AIM 128 | 020 |
| ISBT 128 | 021 |
| ISSN | 023 |
| ISBN | 024 |
| Industrial25 | 025 |
| Standard25 | 026 |
| Plessey | 027 |
| Code11 | 028 |
| MSI-Plessey | 029 |
| GS1 Composite | 030 |
| GS1 Databar (RSS) | 031 |
| PDF417 | 032 |
| QR Code | 033 |
| Aztec | 034 |
| Data Matrix | 035 |
| Chinese Sensible Code | 039 |

| Symbology | ID Number |
|-------------------------|-----------|
| GM Code | 040 |
| Micro PDF417 | 042 |
| Micro QR | 043 |
| Code One | 048 |
| Chinese ID Card OCR | 065 |
| Passport OCR | 066 |
| China Travel Permit OCR | 068 |
| USPS Postnet | 096 |
| USPS Intelligent Mail | 097 |
| Royal Mail | 098 |
| USPS Planet | 099 |
| KIX Post | 100 |
| Australian Postal | 101 |
| Japan Post | 102 |
| Code 49 | 132 |
| Code 16K | 133 |

ASCII Table

| Hex | Dec | Char |
|-----|-----|-------------------------------|
| 00 | 0 | NUL (Null char.) |
| 01 | 1 | SOH (Start of Header) |
| 02 | 2 | STX (Start of Text) |
| 03 | 3 | ETX (End of Text) |
| 04 | 4 | EOT (End of Transmission) |
| 05 | 5 | ENQ (Enquiry) |
| 06 | 6 | ACK (Acknowledgment) |
| 07 | 7 | BEL (Bell) |
| 08 | 8 | BS (Backspace) |
| 09 | 9 | HT (Horizontal Tab) |
| 0a | 10 | LF (Line Feed) |
| 0b | 11 | VT (Vertical Tab) |
| 0c | 12 | FF (Form Feed) |
| 0d | 13 | CR (Carriage Return) |
| 0e | 14 | SO (Shift Out) |
| 0f | 15 | SI (Shift In) |
| 10 | 16 | DLE (Data Link Escape) |
| 11 | 17 | DC1 (XON) (Device Control 1) |
| 12 | 18 | DC2 (Device Control 2) |
| 13 | 19 | DC3 (XOFF) (Device Control 3) |
| 14 | 20 | DC4 (Device Control 4) |
| 15 | 21 | NAK (Negative Acknowledgment) |
| 16 | 22 | SYN (Synchronous Idle) |
| 17 | 23 | ETB (End of Trans. Block) |
| 18 | 24 | CAN (Cancel) |
| 19 | 25 | EM (End of Medium) |
| 1a | 26 | SUB (Substitute) |
| 1b | 27 | ESC (Escape) |
| 1c | 28 | FS (File Separator) |
| 1d | 29 | GS (Group Separator) |

| Hex | Dec | Char |
|-----|-----|--------------------------------|
| 1e | 30 | RS (Request to Send) |
| 1f | 31 | US (Unit Separator) |
| 20 | 32 | SP (Space) |
| 21 | 33 | ! (Exclamation Mark) |
| 22 | 34 | " (Double Quote) |
| 23 | 35 | # (Number Sign) |
| 24 | 36 | \$ (Dollar Sign) |
| 25 | 37 | % (Percent) |
| 26 | 38 | & (Ampersand) |
| 27 | 39 | ` (Single Quote) |
| 28 | 40 | ((Left/ Opening Parenthesis) |
| 29 | 41 |) (Right/ Closing Parenthesis) |
| 2a | 42 | * (Asterisk) |
| 2b | 43 | + (Plus) |
| 2c | 44 | , (Comma) |
| 2d | 45 | - (Minus/ Dash) |
| 2e | 46 | . (Dot) |
| 2f | 47 | / (Forward Slash) |
| 30 | 48 | 0 |
| 31 | 49 | 1 |
| 32 | 50 | 2 |
| 33 | 51 | 3 |
| 34 | 52 | 4 |
| 35 | 53 | 5 |
| 36 | 54 | 6 |
| 37 | 55 | 7 |
| 38 | 56 | 8 |
| 39 | 57 | 9 |
| 3a | 58 | : (Colon) |
| 3b | 59 | ; (Semi-colon) |
| 3c | 60 | < (Less Than) |
| 3d | 61 | = (Equal Sign) |

| Hex | Dec | Char |
|-----|-----|----------------------------|
| 3e | 62 | > (Greater Than) |
| 3f | 63 | ? (Question Mark) |
| 40 | 64 | @ (AT Symbol) |
| 41 | 65 | A |
| 42 | 66 | B |
| 43 | 67 | C |
| 44 | 68 | D |
| 45 | 69 | E |
| 46 | 70 | F |
| 47 | 71 | G |
| 48 | 72 | H |
| 49 | 73 | I |
| 4a | 74 | J |
| 4b | 75 | K |
| 4c | 76 | L |
| 4d | 77 | M |
| 4e | 78 | N |
| 4f | 79 | O |
| 50 | 80 | P |
| 51 | 81 | Q |
| 52 | 82 | R |
| 53 | 83 | S |
| 54 | 84 | T |
| 55 | 85 | U |
| 56 | 86 | V |
| 57 | 87 | W |
| 58 | 88 | X |
| 59 | 89 | Y |
| 5a | 90 | Z |
| 5b | 91 | [(Left/ Opening Bracket) |
| 5c | 92 | \ (Back Slash) |
| 5d | 93 |] (Right/ Closing Bracket) |

| Hex | Dec | Char |
|-----|-----|--------------------------|
| 5e | 94 | ^ (Caret/ Circumflex) |
| 5f | 95 | _ (Underscore) |
| 60 | 96 | ' (Grave Accent) |
| 61 | 97 | a |
| 62 | 98 | b |
| 63 | 99 | c |
| 64 | 100 | d |
| 65 | 101 | e |
| 66 | 102 | f |
| 67 | 103 | g |
| 68 | 104 | h |
| 69 | 105 | i |
| 6a | 106 | j |
| 6b | 107 | k |
| 6c | 108 | l |
| 6d | 109 | m |
| 6e | 110 | n |
| 6f | 111 | o |
| 70 | 112 | p |
| 71 | 113 | q |
| 72 | 114 | r |
| 73 | 115 | s |
| 74 | 116 | t |
| 75 | 117 | u |
| 76 | 118 | v |
| 77 | 119 | w |
| 78 | 120 | x |
| 79 | 121 | y |
| 7a | 122 | z |
| 7b | 123 | { (Left/ Opening Brace) |
| 7c | 124 | (Vertical Bar) |
| 7d | 125 | } (Right/ Closing Brace) |
| 7e | 126 | ~ (Tilde) |
| 7f | 127 | DEL (Delete) |

Keyboard Key References

| | | | | | | | | | | | | | | | | | | | | |
|----|----|----|----|----|----|----|----|----|----|----|----|----|----|----|----|----|----|----|----|----|
| 6E | 70 | 71 | 72 | 73 | 74 | 75 | 76 | 77 | 78 | 79 | 7A | 7B | 7C | 7D | 7E | • | • | • | | |
| 01 | 02 | 03 | 04 | 05 | 06 | 07 | 08 | 09 | 0A | 0B | 0C | 0D | 0F | 4B | 50 | 55 | 5A | 5F | 64 | 69 |
| 10 | 11 | 12 | 13 | 14 | 15 | 16 | 17 | 18 | 19 | 1A | 1B | 1C | 1D | 4C | 51 | 56 | 5B | 60 | 65 | 6A |
| 1E | 1F | 20 | 21 | 22 | 23 | 24 | 25 | 26 | 27 | 28 | 29 | 2B | | | | 5C | 61 | 66 | | |
| 2C | 2E | 2F | 30 | 31 | 32 | 33 | 34 | 35 | 36 | 37 | 39 | | | 53 | | | 5D | 62 | 67 | 6C |
| 3A | 3B | 3C | 3D | | | | | 3E | 3F | 38 | 40 | 4F | 54 | 59 | 63 | 68 | | | | |

104 Key U.S. Style Keyboard

| | | | | | | | | | | | | | | | | | | | | |
|----|----|----|----|----|----|----|----|----|----|----|----|----|----|----|----|----|----|----|----|----|
| 6E | 70 | 71 | 72 | 73 | 74 | 75 | 76 | 77 | 78 | 79 | 7A | 7B | 7C | 7D | 7E | • | • | • | | |
| 01 | 02 | 03 | 04 | 05 | 06 | 07 | 08 | 09 | 0A | 0B | 0C | 0D | 0F | 4B | 50 | 55 | 5A | 5F | 64 | 69 |
| 10 | 11 | 12 | 13 | 14 | 15 | 16 | 17 | 18 | 19 | 1A | 1B | 1C | 2B | 4C | 51 | 56 | 5B | 60 | 65 | 6A |
| 1E | 1F | 20 | 21 | 22 | 23 | 24 | 25 | 26 | 27 | 28 | 29 | 1D | | | | 5C | 61 | 66 | | |
| 2C | 2D | 2E | 2F | 30 | 31 | 32 | 33 | 34 | 35 | 36 | 37 | 39 | | 53 | | | 5D | 62 | 67 | 6C |
| 3A | 3B | 3C | 3D | | | | | 3E | 3F | 38 | 40 | 4F | 54 | 59 | 63 | 68 | | | | |

105 Key European Style Keyboard

Newland AIDC

 No.1 Rujiang West Rd., Mawei, Fuzhou, Fujian 350015, China

 +86-591-83979500

 info@newlandaidc.com

 www.newlandaidc.com

Asia Pacific

Add: 6 Raffles Quay #14-06 Singapore 048582

Email: info@newlandaidc.com

Taiwan:

Add: 7F-6, No. 268, Liancheng Rd.,

Jhonghe Dist. 235, New Taipei City,

Taiwan

Tel: +886 2 7731 5388

Email: info@newlandaidc.com

Japan:

住所: 〒108-0075

東京都港区港南1丁目9-3 6

エリア品川ビル13階407

電話: +84 03 4405 3222

メール: info@newlandaidc.com

Korea:

Add: Biz. Center Best-one, Jang-eun Medical

Plaza 6F, Bojeong-dong 1261-4, Kihung-gu,

Yongin-City, Kyunggi-do, South Korea

Tel: +82 10 8990 4838

Email: info@newlandaidc.com

Indonesia:

Add: Eightyeight@kasablanka Tower A 12th

Floor Unit A&H, Jl. Casablanca Raya Kav. 88,

Jakarta Selatan 12870

Tel: +62 8161157247

Email: info@newlandaidc.com

Vietnam:

Tel: +84 909 345 375

Email: info@newlandaidc.com

India:

Add: Office no. 309-311, 3rd Floor, Tower B,

NOIDA ONE business park B 8, Block B,

Industrial Area, Sector 62, Noida, Uttar

Pradesh 201309

Phone no: +91-120-3201449 /50 /51 /52

Email: info@newlandaidc.com

Europe & Middle East & Africa

Add: Rolweg 25, 4104 AV Culemborg, The Netherlands

Tel: +31 (0) 345 87 00 33

Web: www.newland-id.com

Email: sales@newland-id.com

Tech Support: tech-support@newland-id.com

North America

Add: 46559 Fremont Blvd., Fremont, CA 94538, USA

Tel: +1 510 490 3888

Email: info@newlandaidc.com

North America Channel:

Tel: +1 408 838 3703

Email: info@newlandaidc.com

Latin America

Tel: +1 239 598 0068

Email: info@newlandaidc.com

Brazil:

Tel: +55 35 9767 6078

Colombia:

Tel: +57 319 387 4484

Chile:

Tel: +56 9 9337 3177

Mexico, Central America & Caribbean:

Tel: +52 155 5432 9079



Newland AIDC
Scanning Made Simple

