

MS47 Series

Fixed Mount Imager



ZEBRA

Integration Guide

Copyright

ZEBRA and the stylized Zebra head are trademarks of Zebra Technologies Corporation, registered in many jurisdictions worldwide. All other trademarks are the property of their respective owners. ©2025 Zebra Technologies Corporation and/or its affiliates. All rights reserved. Information in this document is subject to change without notice. The software described in this document is furnished under a license agreement or nondisclosure agreement. The software may be used or copied only in accordance with the terms of those agreements.

For further information regarding legal and proprietary statements, please go to:

SOFTWARE: zebra.com/linkoslegal

COPYRIGHTS: zebra.com/copyright

PATENTS: ip.zebra.com

WARRANTY: zebra.com/warranty

END USER LICENSE AGREEMENT: zebra.com/eula

Terms of Use

- Proprietary Statement

This manual contains proprietary information of Zebra Technologies Corporation and its subsidiaries (“Zebra Technologies”). It is intended solely for the information and use of parties operating and maintaining the equipment described herein. Such proprietary information may not be used, reproduced, or disclosed to any other parties for any other purpose without the express, written permission of Zebra Technologies.

- Product Improvements

Continuous improvement of products is a policy of Zebra Technologies. All specifications and designs are subject to change without notice.

- Liability Disclaimer

Zebra Technologies takes steps to ensure that its published Engineering specifications and manuals are correct; however, errors do occur. Zebra Technologies reserves the right to correct any such errors and disclaims liability resulting therefrom.

- Limitation of Liability

In no event shall Zebra Technologies or anyone else involved in the creation, production, or delivery of the accompanying product (including hardware and software) be liable for any damages whatsoever (including, without limitation, consequential damages including loss of business profits, business interruption, or loss of business information) arising out of the use of, the results of use of, or inability to use such product, even if Zebra Technologies has been advised of the possibility of such damages. Some jurisdictions do not allow the exclusion or limitation of incidental or consequential damages, so the above limitation or exclusion may not apply to you.

Revision History

Changes to the original guide are listed below:

Change	Date	Description
-13 Rev A	10/2025	Added GS1 Digital Link Parameters and GS1 Retail Parsing
-12 Rev A	08/2025	Updated the list of operating systems to include Windows 11 in the Connecting a USB Interface and 123Scan Requirements sections.
-11 Rev A	01/2025	<p>Updated Release:</p> <p>Added:</p> <p>USB Interface:</p> <ul style="list-style-type: none"> - Product ID (PID Value), Parameter #1725 (SSI #F8h 06h BDh) - USB CDC Host Variant, Parameter #1713 - Datalogic Host Format, Parameter #2253 (SSI #F8 08 CD) - Datalogic Supported Commands, Parameter #2260 (SSI #F8 08 D4) <p>Codabar:</p> <ul style="list-style-type: none"> - Codabar Security Level, Parameter #1776 (SSI #F8h 06h F0h) - Codabar Mod 16 Check Digit Verification, Parameter #1784 (SSI #F8h 06h F8h) - Transmit Codabar Check Digit #704 (SSI #F1h C0h) <p>Composite</p> <ul style="list-style-type: none"> - Composite Inverse, Parameter #1113 (SSI #F8h 04h 59h) <p>2D Symbolologies</p> <ul style="list-style-type: none"> - Grid Matrix, Parameter #1718 (SSI #F8 06h B6h) - Grid Matrix Inverse, Parameter #1719 (SSI #F8h 06h B7h) - Grid Matrix Mirrored, Parameter #1736 (SSI #F8h 06h C8h) - GS1 DataBar Security Level, Parameter #1706 (SSI #F8h 06h AAh) - Linked QR Mode, Parameter #1847 (SSI #737h) <p>Imager Preferences</p> <ul style="list-style-type: none"> - Aim Brightness, Parameter #668 (SSI #F1h 9Ch) <ul style="list-style-type: none"> - Corrected full-resolution pixel value for Disable Image Cropping. - Updated Configuration table in About This Guide chapter.
-10 Rev A	07/2024	<p>Updated Release:</p> <ul style="list-style-type: none"> - Removed "Parameter # 94 (SSI # 5Eh)" - Updated note for Illumination Brightness: Parameter # 669 - Updated "DS3678" to "MS47" in the description for OCR Check Digit Multiplier: Parameter # 700 (SSI # F1h BCh)
-09 Rev A	11/2023	<p>Updated Release:</p> <p>Digimarc: Updated default</p> <p>Crop to Pixel Addresses: Updated value of Top and Bottom Pixel Addresses</p> <p>Scene Detect Mode (Wakeup): Updated default</p>
-08 Rev A	11/2023	<p>Updated Release:</p> <ul style="list-style-type: none"> - Table 6 MS4717 Decode Ranges - Updated Hands-Free Decode Session Timeout # 400 and Low Light Motion Detection Assist # 810 - Added Scene Detect Mode (Wakeup) Parameter # 2377

Change	Date	Description
-07 Rev A	3/2023	Updated Release: - Removed Mobile Apps section and Imager SDK for iOS under Imager SDK, Other Software Tools, and Videos
-06 Rev A	3/2023	Updated Release: - MS4777/MS4727 Information
-05 Rev A	2/2023	Updated Release: - Updated OCR Template for Parameter 547.
-04 Rev A	7/2021	Removed: - Provide Documentation Feedback Added: - Digimarc - A note in Mirrored Image - DotCode - DotCode Inverse - DotCode Mirrored - DotCode Prioritize - DotCode Erasure Limit. Split ADF section from 123Scan chapter and created new Data Formatting chapter.
-03 Rev A	5/2020	Updated Release: - Added Mirrored Image Parameter
-02 Rev A	4/2020	Updated Release: - Mounting instructions for Cone included - Decode Ranges to include Cone - Added Driver's License Parsing Chapter
-01 Rev A	4/2019	Initial Release

Contents

Copyright	2
Terms of Use	2
Revision History	3
About This Guide	
Introduction	17
Configurations	17
Chapter Descriptions	18
Notational Conventions	20
Related Documents	20
Service Information	20
Getting Started	
Introduction	21
MS47 Features	21
Theory of Operation	22
MS47 Block Diagram Descriptions	22
MS47 Decoder/Interface Board	23
123Scan	
Introduction	24
123Scan	24
Communication with 123Scan	25
123Scan Requirements	25
123Scan Information	25
Imager SDK, Other Software Tools, and Videos	26
Installation	
Introduction	27
Mounting	27
MS47 Mounting Dimensions	27
Connecting the MS47	29
Accessories	30
Location and Positioning	30

Window Material	31
Cell Cast Acrylic (ASTM: PMMA)	31
Cell Cast ADC (ASTM: ADC)	31
Chemically Tempered Glass	31
Commercially Available Coatings	31
Anti-Reflection Coatings	31
Polysiloxane Coating	32
A Word About Coatings	32
Embedded Window Angle and Position	33
MS4717 Optical Path	34
MS4727 Optical Path	35
MS4777 Optical Path	35
MS47 Recommended Exit Window Information	36
Exit Window Notes	36
MS4717 Cone Optical Path	37
MS4727 Cone Exit Window Optical Zone	39
MS4777 Cone Exit Window Optical Zone	40
MS4717 Cone Exit Window Optical Zone	41
MS4727/MS4777 Cone Exit Window Optical Zone	42
Zebra SNAPi Software Developer's Kit	43
Scanning	
Introduction	44
Imaging System	44
Aiming System	44
Aiming with MS47	44
Aiming Error	45
Aiming Control	45
Illumination System	45
Illumination Control	46
Supported Symbologies	46
Operating Modes	46
Specifications	
MS47 Series Fixed Mount Imager Technical Specifications	47
MS4777 Regulatory Considerations	49
Required Documentation for All End Products	50
Skew, Pitch and Roll	51
MS4717 Decode Zones	52
MS4727/MS4777 Decode Zones	53
Maintenance and Troubleshooting	
Introduction	54
Maintenance	54
Troubleshooting	54

User Preferences

Introduction	56
Scanning Sequence Examples	57
Errors While Scanning	57
User Preferences Parameter Defaults	57
User Preferences	59
Default Parameters	59
Parameter Barcode Scanning	60
Beep After Good Decode	61
Beep on <BEL>	61
Lock/Unlock Parameter Scanning	62
Beeper Volume	63
Beeper Tone	64
Beeper Duration	65
Suppress Power Up Beeps	65
Trigger Mode	66
Presentation Decode Aiming Pattern	67
Picklist Mode	68
Decode Session Timeout	69
Hands-Free Decode Session Timeout	69
Timeout Between Decodes, Same Symbol	71
Timeout Between Decodes, Different Symbols	71
Mobile Phone/Display Mode	72
Scene Detect Mode (Wakeup)	73
PDF Prioritization	74
PDF Prioritization Timeout	75
Low Light Motion Detection Assist	76
Presentation Mode Field of View	77
Scene Detect Sensitivity	78
Mirrored Image	78
Decoding Illumination	79
Add an Enter Key	79
Transmit Code ID Character	80
Prefix/Suffix Values	81
Scan Data Transmission Format	82
FN1 Substitution Values	83
Transmit “No Read” Message	84
Unsolicited Heartbeat Interval	85
Report Version	86
Report Decoder Manufacturing Information	86
Report Engine Manufacturing Information	86

Imager Preferences

Introduction	87
Scanning Sequence Examples	88
Errors While Scanning	88
Imaging Preferences Parameter Defaults	88
Imager Preferences	90
Operational Modes	90
Aim Brightness	91

Illumination Brightness	91
Image Capture Illumination	92
Image Capture Autoexposure	92
Fixed Exposure	94
Gain/Exposure Priority for Snapshot Mode	95
Snapshot Mode Timeout	96
Snapshot Aiming Pattern	97
Silence Operational Mode Changes	97
Image Cropping	98
Crop to Pixel Addresses	99
Image Size (Number of Pixels)	100
Image Brightness (Target White)	101
JPEG Image Options	101
JPEG Target File Size	102
JPEG Quality	102
Image Enhancement	103
Image File Format Selector	104
Image Rotation	105
Bits Per Pixel (BPP)	106
Signature Capture	107
Signature Capture Image File Format Selection	108
Signature Capture Bits Per Pixel	109
Signature Capture Width	110
Signature Capture Height	110
Signature Capture JPEG Quality	110
Video View Finder Image Size	111
Video View Finder	112

USB Interface

Introduction	113
Connecting a USB Interface	113
USB Parameter Defaults	114
USB Host Parameter	116
USB Device Type	116
Symbol Native API (SNAPI) Status Handshaking	118
USB Keystroke Delay	118
USB CAPS Lock Override	119
USB Ignore Unknown Characters	120
USB Convert Unknown to Code 39	120
Emulate Keypad	121
Emulate Keypad with Leading Zero	121
Quick Keypad Emulation	122
USB Keyboard FN 1 Substitution	122
Function Key Mapping	123
Simulated Caps Lock	123
Convert Case	124
USB CDC Host Variant	125
USB Static CDC	125
Product ID (PID) Type	126
Product ID (PID) Value	126

Datalogic Host Format	127
Datalogic Supported Commands	127
Optional USB Parameters	128
Ignore Beep Directive	128
Ignore Barcode Configuration	128
USB Polling Interval	129
USB Fast HID	131
IBM Specification Version	131
ASCII Character Set for USB	131
SSI Interface	
Introduction	132
Communications	132
SSI Transactions	134
General Data Transactions	134
Transfer of Decode Data	135
Communication Summary	136
ACK/NAK Option	136
Number of Data Bits	136
Serial Response Time-out	136
Retries	137
Response Time-out and ACK/NAK Handshake	137
Errors	137
Things to Remember When Using SSI Communication	137
Encapsulation of RSM Commands/Responses over SSI	138
Command Structure	138
Response Structure	138
Example Transaction	139
Simple Serial Interface Default Parameters	140
SSI Host Parameters	141
Decode Data Packet Format	142
Host Serial Response Time-out	143
Host Character Time-out	144
Multipacket Option	145
Interpacket Delay	146
Event Reporting	147
Decode Event	147
Boot Up Event	148
Parameter Event	148
Symbologies	
Introduction	149
Scanning Sequence Examples	149
Errors While Scanning	149
Symbology Parameter Defaults	150
Enable/Disable All Code Types	156
UPC/EAN	157
Enable/Disable UPC-A	157

Contents

Enable/Disable UPC-E	157
Enable/Disable UPC-E1	158
Enable/Disable EAN-8/JAN-8	158
Enable/Disable EAN-13/JAN-13	159
Enable/Disable Bookland EAN	159
Decode UPC/EAN/JAN Supplementals	160
User-Programmable Supplementals	163
UPC/EAN/JAN Supplemental Redundancy	163
UPC/EAN/JAN Supplemental AIM ID Format	164
UPC Reduced Quiet Zone	165
Transmit UPC-A Check Digit	165
Transmit UPC-E Check Digit	166
Transmit UPC-E1 Check Digit	166
UPC-A Preamble	167
UPC-E Preamble	168
UPC-E1 Preamble	169
Convert UPC-E to UPC-A	170
Convert UPC-E1 to UPC-A	170
EAN-8/JAN-8 Extend	171
Bookland ISBN Format	171
UCC Coupon Extended Code	172
Coupon Report	173
ISSN EAN	173
Code 128	174
Enable/Disable Code 128	174
Set Lengths for Code 128	175
Enable/Disable GS1-128 (formerly UCC/EAN-128)	176
Enable/Disable ISBT 128	176
ISBT Concatenation	177
Check ISBT Table	178
ISBT Concatenation Redundancy	178
Code 128 Security Level	179
Code 128 Reduced Quiet Zone	180
Ignore Code 128 <FNC4>	180
Code 39	181
Enable/Disable Code 39	181
Enable/Disable Trioptic Code 39	181
Convert Code 39 to Code 32	182
Code 32 Prefix	182
Set Lengths for Code 39	183
Code 39 Check Digit Verification	184
Transmit Code 39 Check Digit	184
Code 39 Full ASCII Conversion	185
Code 39 Security Level	186
Code 39 Reduced Quiet Zone	187
Code 93	187
Enable/Disable Code 93	187
Set Lengths for Code 93	188
Code 11	189
Code 11	189
Set Lengths for Code 11	190

Contents

Code 11 Check Digit Verification	191
Transmit Code 11 Check Digit(s)	192
Interleaved 2 of 5 (ITF)	192
Enable/Disable Interleaved 2 of 5	192
Set Lengths for Interleaved 2 of 5	193
I 2 of 5 Check Digit Verification	194
Transmit I 2 of 5 Check Digit	195
Convert I 2 of 5 to EAN-13	195
I 2 of 5 Security Level	196
I 2 of 5 Reduced Quiet Zone	197
Discrete 2 of 5 (DTF)	197
Enable/Disable Discrete 2 of 5	197
Set Lengths for Discrete 2 of 5	198
Codabar (NW - 7)	199
Enable/Disable Codabar	199
Set Lengths for Codabar	200
CLSI Editing	201
NOTIS Editing	201
Codabar Upper or Lower Case Start/Stop Characters Detection	202
Codabar Security Level	203
Codabar Mod 16 Check Digit Verification	204
Transmit Codabar Check Digit	204
MSI	205
Enable/Disable MSI	205
Set Lengths for MSI	206
MSI Check Digits	207
Transmit MSI Check Digit(s)	207
MSI Check Digit Algorithm	208
Chinese 2 of 5	208
Enable/Disable Chinese 2 of 5	208
Matrix 2 of 5	209
Enable/Disable Matrix 2 of 5	209
Set Lengths for Matrix 2 of 5	210
Matrix 2 of 5 Check Digit	211
Transmit Matrix 2 of 5 Check Digit	211
Korean 3 of 5	212
Enable/Disable Korean 3 of 5	212
Inverse 1D	213
GS1 DataBar	214
GS1 DataBar-14	214
GS1 DataBar Limited	214
GS1 DataBar Expanded	215
Convert GS1 DataBar to UPC/EAN	215
GS1 DataBar Security Level	216
GS1 DataBar Limited Security Level	217
GS1 Digital Link Parameters	218
GS1 Digital Link	218
GS1 Digital Link Mode	218
GS1 Digital Link Prioritization Timeout	219
Composite	220
Composite CC-C	220

Contents

Composite CC-A/B	220
Composite TLC-39	221
Composite Inverse	221
UPC Composite Mode	222
Composite Beep Mode	223
GS1-128 Emulation Mode for UCC/EAN Composite Codes	223
2D Symbologies	224
Enable/Disable PDF417	224
Enable/Disable MicroPDF417	224
Code 128 Emulation	225
Data Matrix	226
GS1 Data Matrix	226
Data Matrix Inverse	227
Maxicode	227
QR Code	228
GS1 QR	228
MicroQR	229
Linked QR Mode	229
Aztec	230
Aztec Inverse	230
Han Xin	231
Han Xin Inverse	231
Grid Matrix	232
Grid Matrix Inverse	232
Grid Matrix Mirrored	233
DotCode	234
DotCode Inverse	234
DotCode Mirrored	235
DotCode Prioritize	235
DotCode Erasure Limit	236
Postal Codes	237
US Postnet	237
US Planet	237
Transmit US Postal Check Digit	238
UK Postal	238
Transmit UK Postal Check Digit	239
Japan Postal	239
Australia Post	240
Australia Post Format	241
Netherlands KIX Code	242
USPS 4CB/One Code/Intelligent Mail	242
UPU FICS Postal	243
Mailmark	243
Symbology-Specific Security Levels	244
Redundancy Level	244
Security Level	246
1D Quiet Zone Level	247
Intercharacter Gap Size	248
Report Version	248
Macro PDF Features	249
Flush Macro Buffer	249

Abort Macro PDF Entry	249
Digimarc	
Introduction	250
Digimarc Parameter Defaults	250
Digimarc Symbology	250
Picklist	251
Digimarc Digital Watermarks	251
Digimarc Data Mode	252
Digimarc GIA17 Format	253
Data Formatting	
Introduction	254
Advanced Data Formatting (ADF)	254
Multicode Data Formatting	254
MDF in Hands-Free Mode	255
MDF Best Practices	256
Preferred Symbol	257
Data Parsing (UDI Scan+, Label Parse+ and Blood Bag Parse+)	257
Scan a UDI Label using UDI Scan+	257
Scan a GS1 Label using Label Parse+	258
Scan a Blood Bag Label using Blood Bag Parse+	258
Scan a Gs1 Retail POS Label using GS1 Digital Link Parsing	258
OCR Programming	
Introduction	259
OCR Programming Parameters	261
Enable/Disable OCR-A	261
OCR-A Variant	261
Enable/Disable OCR-B	263
OCR-B Variant	264
Enable/Disable MICR E13B	267
Enable/Disable US Currency Serial Number	268
OCR Orientation	268
OCR Lines	270
OCR Minimum Characters	270
OCR Maximum Characters	271
OCR Subset	271
OCR Quiet Zone	272
OCR Template	273
OCR Check Digit Modulus	283
OCR Check Digit Multiplier	284
OCR Check Digit Validation	285
Inverse OCR	290
OCR Redundancy	291

Driver's License Set Up	
Introduction	292
Driver's License Parsing	293
Parsing Driver's License Data Fields (Embedded Driver's License Parsing)	294
Embedded Driver's License Parsing Criteria - Code Type	294
Driver's License Parse Field Barcodes	295
AAMVA Parse Field Barcodes	297
User Preferences	307
Set Default Parameter	307
Output Gender as M or F	307
Date Format	308
Send Keystroke (Control Characters and Keyboard Characters)	310
Parsing Rule Example	328
Embedded Driver's License Parsing ADF Example	332
Standard Default Parameters	
Country Codes	
Introduction	346
USB Country Keyboard Types (Country Codes)	347
Country Code Pages	
Introduction	362
Country Code Page Defaults	362
Country Code Page Barcodes	366
CJK Decode Control	
Introduction	375
CJK Control Parameters	376
Unicode Output Control	376
CJK Output Method to Windows Host	377
Non-CJK UTF Barcode Output	379
Unicode/CJK Decode Setup with Windows Host	381
Setting Up the Windows Registry Table for Unicode Universal Output	381
Adding CJK IME on Windows	381
Selecting the Simplified Chinese Input Method on the Host	382
Selecting the Traditional Chinese Input Method on the Host	383
Programming Reference	
Symbol Code Identifiers	384
AIM Code Identifiers	386

Sample Barcodes

Code 39	391
UPC/EAN	391
UPC-A, 100%	391
EAN-13, 100%	391
Code 128	392
Interleaved 2 of 5	392
GS1 DataBar-14	393
PDF417	393
Data Matrix	393
Maxicode	393
QR Code	394
US Postnet	394
UK Postal	394

Alphanumeric Barcodes

Alphanumeric Barcodes	395
-----------------------------	-----

Numeric Barcodes

Numeric Barcodes	412
Cancel	413

ASCII Character Sets

Communication Protocol Functionality

Functionality Supported via Communication (Cable) Interface	426
---	-----

Signature Capture Code

Introduction	427
Code Structure	427
Signature Capture Area	427
CapCode Pattern Structure	428
Start / Stop Patterns	428
Dimensions	429
Data Format	429
Additional Capabilities	430
Signature Boxes	430

Non-Parameter Attributes

Introduction	431
Attributes	431
Model Number	431
Serial Number	431

Contents

Date of Manufacture	431
Date of First Programming	432
Configuration Filename	432
Beeper/LED	433
Parameter Defaults	434
Reboot	434
Host Trigger Session	434
Firmware Version	434
Scankit Version	435
ImageKit Version	435

About This Guide

Introduction

The MS47 Fixed Mount Imager Series Integration Guide provides general instructions for mounting, installation, scanning, and programming for MS4717, MS4727 and MS4777 fixed mount imagers.

Configurations

Configuration	Description
MS4717-LU000R	Fixed Mount: 2D Imager, SE4710, Red Illumination, Amber LED Aim, USB
MS4717-LU000Y	Fixed Mount: 2D Imager, SE4710, Red Illumination, Amber LED Aim, USB, India
MS4717-LU0C0R	Fixed Mount: 2D Imager, SE4710, Red Illumination, Amber LED Aim, USB, Cone Attachment
MS4717-LU100R	Fixed Mount: 2D Imager, SE4710, Red Illumination, Amber LED Aim, USB, DL Parsing
MS4717-LU1C0R	Fixed Mount: 2D Imager, SE4710, Red Illumination, Amber LED Aim, USB, DL Parsing, Cone Attachment
MS4727-LU000R	Fixed Mount: 2D Imager, SE4720, White Illum, Green LED Aimer, USB
MS4727-LU000Y	Fixed Mount: 2D Imager, SE4720, White Illum, Green LED Aimer, USB, India
MS4727-LU0C0R	Fixed Mount: 2D Imager, SE4720, White Illum, Green LED Aimer, USB, Cone Attachment
MS4727-LU0C0Y	Fixed Mount: 2D Imager, SE4720, White Illum, Green LED Aimer, USB, Cone Attachment, India
MS4727-LU100R	Fixed Mount: 2D Imager, SE4720, White Illum, Green LED Aimer, USB, DL Parsing
MS4727-LU1C0R	Fixed Mount: 2D Imager, SE4720, White Illum, Green LED Aimer, USB, DL Parsing, Cone Attachment
MS4777-LU000R	Fixed Mount: 2D Imager, SE4770, White Illum, Red Laser Aimer, USB
MS4777-LU000Y	Fixed Mount: 2D Imager, SE4770, White Illum, Red Laser Aimer, USB, India

Configuration	Description
MS4777-LU0C0R	Fixed Mount: 2D Imager, SE4770, White Illum, Red Laser Aimer, USB, Cone Attachment
MS4777-LU0C0Y	Fixed Mount: 2D Imager, SE4770, White Illum, Red Laser Aimer, USB, Cone Attachment, India
MS4777-LU100R	Fixed Mount: 2D Imager, SE4770, White Illum, Red Laser Aimer, USB, DL Parsing
MS4777-LU1C0R	Fixed Mount: 2D Imager, SE4770, White Illum, Red Laser Aimer, USB, DL Parsing, Cone Attachment

Chapter Descriptions

Topics covered in this guide are as follows:

- [Getting Started](#) provides general information about the imager, including its features and theory of operation.
- [123Scan](#) describes the Zebra software tools available for customizing imager operation.
- [Installation](#) provides information on mounting and installing the fixed mount engine.
- [Scanning](#) provides information on aiming, illumination, data capture, beeper and decode LED feedback, supported symbologies, and operating modes.
- [Specifications](#) provides specification details and decode ranges.
- [Maintenance and Troubleshooting](#) provides information on maintenance and troubleshooting.
- [User Preferences](#) describes each user preference feature and provides the programming barcodes necessary for selecting these features.
- [Imager Preferences](#) describes scanner preference features and provides the programming barcodes for selecting these features.
- [USB Interface](#) provides instructions for programming the imager to interface with a USB host.
- [SSI Interface](#) describes how to set up the decoder with a Simple Serial Interface (SSI) host. Use SSI to program the decoder via barcode menu or SSI hosts commands.
- [Symbologies](#) describes symbology features and provides the programming barcodes for selecting these features.
- [Digimarc](#) provides barcodes to either enable or disable Digimarc Barcode, a machine-readable code that is invisible to people.
- [Data Formatting](#) briefly describes the Zebra features available for customizing scanner operation.
- [OCR Programming](#) describes how to set up the imager for OCR programming.
- [Driver's License Set Up](#) describes how the imager can parse out information from standard US driver's licenses and certain other American Association of Motor Vehicle Administrators (AAMVA) compliant ID cards.
- [Standard Default Parameters](#) provides a table of all host devices and miscellaneous scanner defaults.
- [Country Codes](#) provides barcodes for programming the country keyboard type for the USB keyboard (HID) device.
- [Country Code Pages](#) provides barcodes for selecting code pages for the country keyboard type.
- [CJK Decode Control](#) describes control parameters for Unicode/CJK (Chinese, Japanese, Korean) barcode decode through USB HID Keyboard Emulation mode.

About This Guide

- [Programming Reference](#) provides a table of AIM code identifiers, ASCII character conversions, and keyboard maps.
- [Sample Barcodes](#) includes sample barcodes of various code types.
- [Alphanumeric Barcodes](#) includes the alphanumeric barcodes to scan for parameters requiring specific alphanumeric values.
- [Numeric Barcodes](#) includes the numeric barcodes to scan for parameters requiring specific numeric values.
- [ASCII Character Sets](#) provides ASCII character value tables.
- [Communication Protocol Functionality](#) lists supported scanner functionality by communication protocol.
- [Signature Capture Code](#) describes CapCode, a special pattern that encloses a signature area on a document and allows the scanner to capture a signature.
- [Non-Parameter Attributes](#) defines non-parameter attributes.

Notational Conventions

The following conventions are used in this document:

- “Imager” refers to the MS47 fixed mount imager (MS4717, MS4727, or MS4777). When describing an individual imager, the device model is mentioned specifically.
- Bullets (•) indicate:
 - Action items
 - Lists of alternatives
 - Lists of required steps that are not necessarily sequential.
- Sequential lists (e.g., those that describe step-by-step procedures) appear as numbered lists.

Related Documents

The following documents provide more information about the imager.

- MS47 Fixed Mount Imager Series Quick Reference Guide (p/n MN-004662-xx).

For the latest version of these guides and software, visit: zebra.com/support.

Service Information

If you have a problem using the equipment, contact your facility's technical or systems support. If there is a problem with the equipment, they will contact the Zebra Global Customer Support Center at: zebra.com/support.

When contacting Zebra support, please have the following information available:

- Serial number of the unit
- Model number or product name
- Software type and version number.

Zebra responds to calls by e-mail, telephone or fax within the time limits set forth in support agreements.

If your problem cannot be solved by Zebra support, you may need to return your equipment for servicing and will be given specific directions. Zebra is not responsible for any damages incurred during shipment if the approved shipping container is not used. Shipping the units improperly can possibly void the warranty. If you purchased your business product from a Zebra business partner, contact that business partner for support.

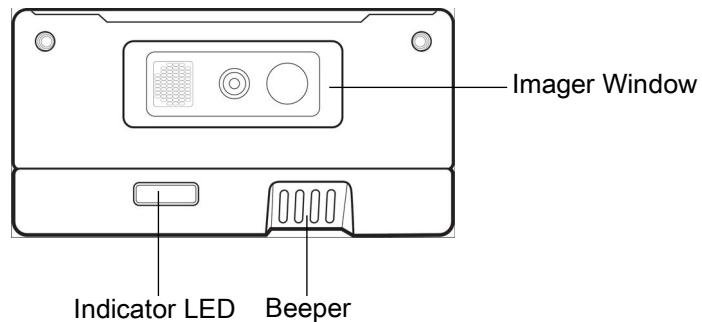
Getting Started

Introduction

MS47 fixed mount imagers are specifically designed to be mounted into various enclosures such as a food ordering kiosk in a quick-serve restaurant or a ticketing kiosk at the airport. The imager provides an easy and flexible integration into most USB host devices and offers high performance scanning on both 1D and 2D barcodes.

This section describes the imager's features, theory of operation, and includes a block diagram illustrating functional relationships of the imager's components.

Figure 1 MS47 Fixed Mount Imager Features



MS47 Features

- Quick and easy integration for OEM devices
- Excellent imaging performance on all 1D and 2D barcodes
- USB interface
- LEDs indicating power status and successful decodes
- Easy programming and configuration
- Flexible mounting options

Theory of Operation

During image capture:

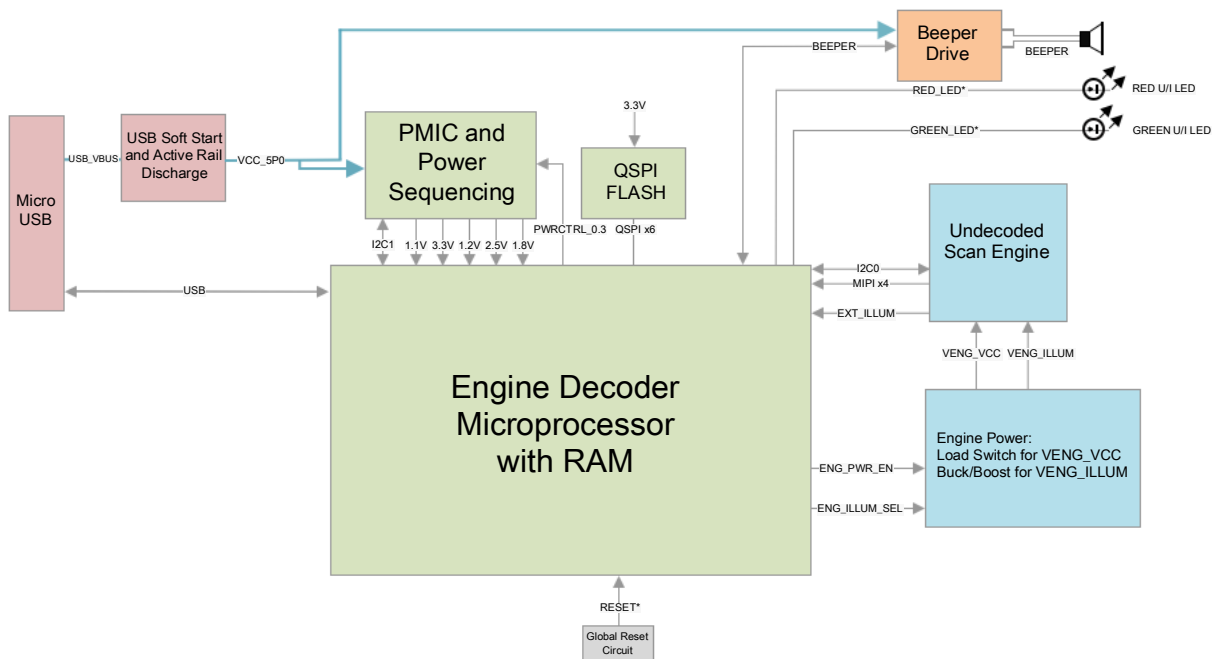
1. The image sensor array in the embedded imaging engine captures an image of the barcode through the engine's optical lens. If necessary, the engine automatically adjusts illumination, exposure, and other parameters to obtain the best quality image.
2. The imaging engine sends the image to the MS47 CPU.
3. The MS47 CPU processes the image to identify the target barcode(s), decodes them, and transmits the decoded data to the host.

Set various parameters provided in this guide to adjust the performance of the MS47 to match the application or desired usage profile.

Block Diagram

The MS47 scanner block diagram illustrates the functional relationship of the MS47 components. This section also provides a description of each component in the block diagrams.

Figure 2 MS47 Block Diagram



MS47 Block Diagram Descriptions

Scan Engine - The imaging engine captures 8-bit gray scale WVGA images at 30 fps (MS4717) or 60 fps (MS4727/MS4777), which are sent uncompressed to a companion board for processing. The engine uses an aim pattern for intuitive aiming and features LED illumination.

Decoder Interface - The decoder board is a companion decoder module for the imaging engine, which controls the engine, receives images, decodes 1D and 2D symbologies, and performs various image processing tasks. The board controls red and green LEDs for visual feedback, and supports SNAPI (Symbol Native API) as well as USB

HID Keyboard through a micro USB connector. The micro USB connector provides an outlet for the various interface signals used between the MS47 and the host.

MS47 Decoder/Interface Board

Power Management

- **USB Host Interface** - The MS47 series automatically manages its power usage, including USB suspend mode. Additionally, when drawing power from the USB bus, the MS47 does not exceed the USB limit of 500 mA when the power provided is 5V +/- 5% and does not exceed 530mA when the power provided is outside +/- 5% and within 10%.

123Scan

Introduction

This chapter briefly describes the Zebra software tools available for customizing imager operation.

123Scan

123Scan is a software tool that simplifies imager setup and more.

Intuitive enough for first time users, the 123Scan wizard guides users through a streamlined setup process. Settings are saved in a configuration file that can be printed as a single programming barcode for scanning, emailed to a smart phone for scanning from its screen, or downloaded to the imager using a USB cable.

Through 123Scan a user can:

- Configure a imager using a wizard.
 - Program the following imager settings.
 - Beeper tone / volume settings.
 - Enable / disable symbologies.
 - Communication settings.
 - Modify data before transmission to a host using Advanced Data Formatting (ADF).
- Load parameter settings to a imager via the following.
 - Barcode scanning.
 - Scan a paper barcode.
 - Scan a barcode from a PC screen.
 - Scan a barcode from a smart phone screen.
 - Download over a USB cable.
 - Load settings to one imager.
 - Stage up to 10 imagers simultaneously (Powered USB Hub recommended with 0.5 amp / port).
- Validate imager setup.
 - View scanned data within the utility's **Data** view screen.
 - Capture an image and save to a PC within the utility's **Data** view screen.
 - Review settings using the Parameter Report.
 - Clone settings from an already deployed scanner from the **Start** screen.

- Upgrade scanner firmware.
 - Load settings to one imager.
 - Stage up to 10 imagers simultaneously (Powered USB Hub recommended with 0.5 amp / port).
- View statistics such as:
 - Asset tracking information.
 - Time and usage information.
 - Barcodes scanned by symbology.
 - Battery diagnostics (select scanners).
- Generate the following reports.
 - Barcode Report - Programming barcode, included parameter settings, and supported imager models.
 - Parameter Report - Parameters programmed within a configuration file.
 - Inventory Report - Scanner asset tracking information.
 - Validation Report - Scanned data from the **Data** view.
 - Statistics Report - All statistics retrieved from the imager.

For more information go to: zebra.com/123Scan

Communication with 123Scan

Use a USB cable to connect the scanner to a Windows host computer running 123Scan.

123Scan Requirements

- Host computer running Windows 7, 8, 10, and 11
- Imager
- USB cable

123Scan Information

For more information on 123Scan, go to: zebra.com/123Scan

For a 1 minute tour of 123Scan, go to: zebra.com/ScannerHowToVideos

To see a list of all of our software tools, go to: zebra.com/scannersoftware

Imager SDK, Other Software Tools, and Videos

Tackle all your imager programming needs with our diversified set of software tools. Whether you need to simply stage a device, or develop a fully featured application with image and data capture as well as asset management, these tools help you every step of the way.

To download any of the following free tools, go to: zebra.com/scannersoftware

- 123Scan configuration utility
- SDKs
 - Imager SDK for Windows
 - Imager SDK for Linux
 - Imager SDK for Android
- Drivers (select scanners)
 - OPOS driver
 - JPOS driver
 - USB CDC driver
 - TWAIN driver
- Scanner Management Service (SMS) for Remote Management
 - Windows
 - Linux
- How-To-Videos

Installation

Introduction

This chapter provides information on mounting, installing, and connecting the imager with compatible accessories. This chapter also provides window information; such as material, coatings. Lastly, this section illustrates the imager's optical path and includes recommended exit window information.

Mounting

The following figures provide the mounting dimensions.



NOTE: Do not use screws that penetrate more than 5 mm into the bottom mousing of the MS47 since this is the maximum depth of the useful thread.

MS47 Mounting Dimensions

Figure 3 Mounting Dimensions (Left Side View)

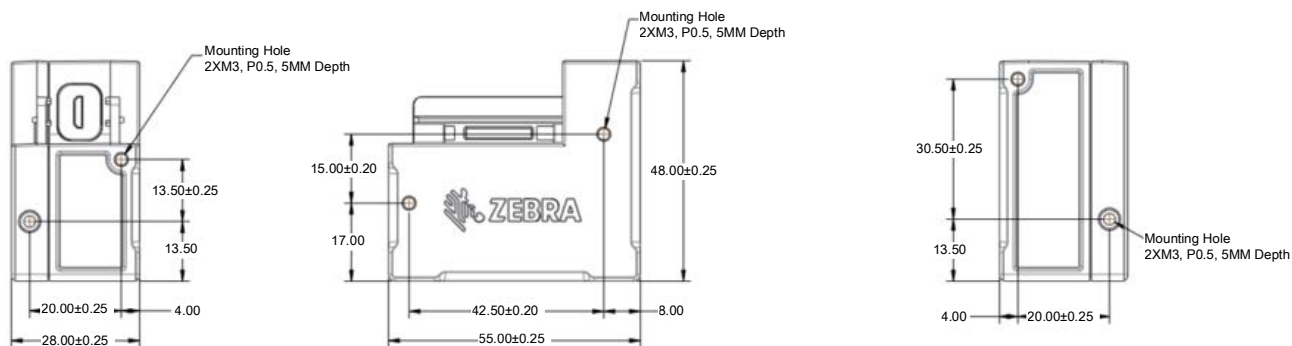
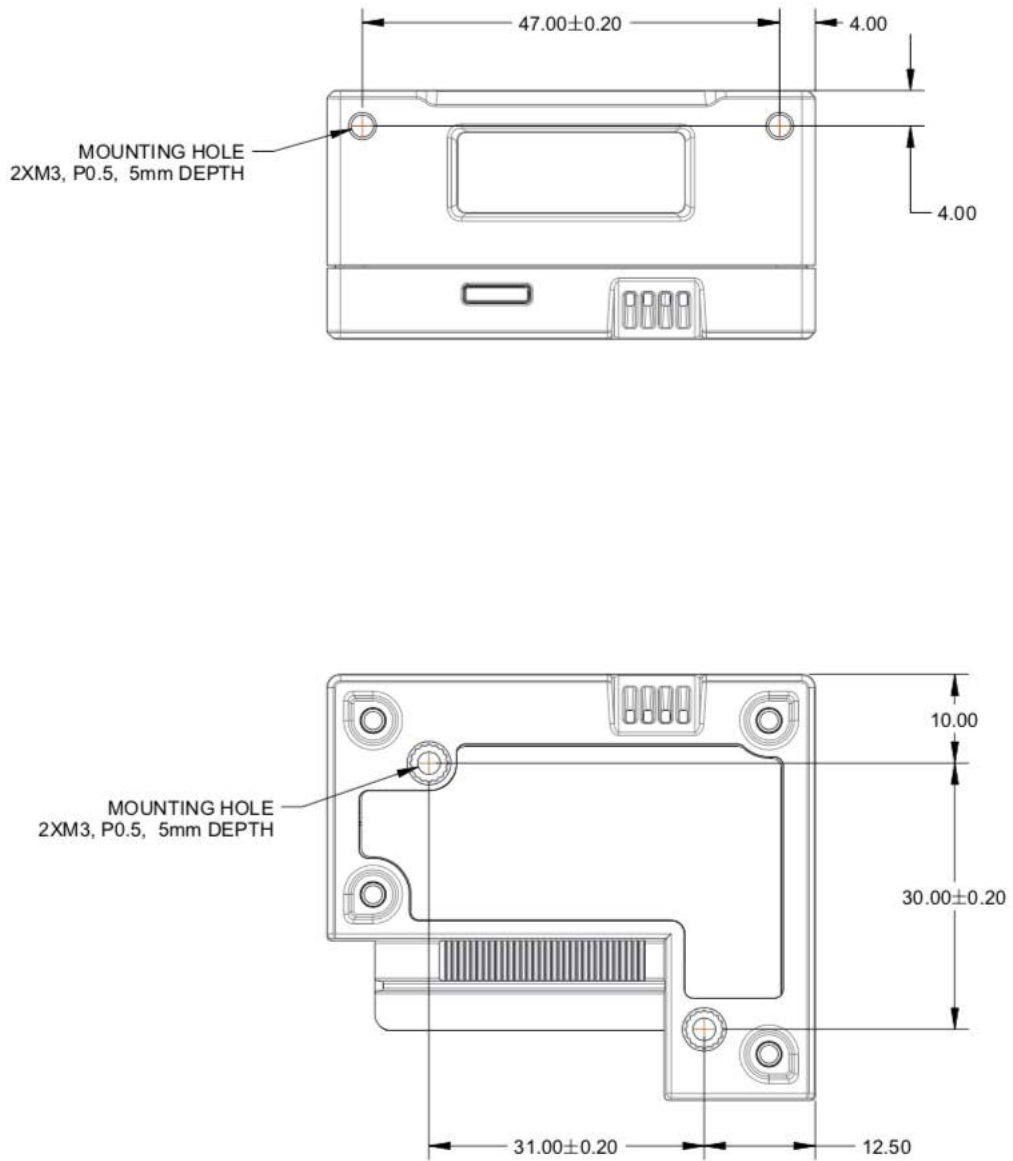


Figure 4 Mounting Dimensions

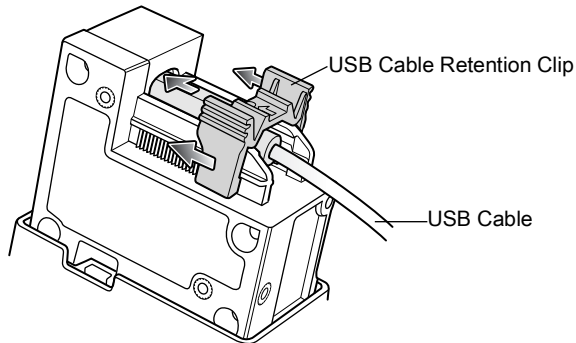


Connecting the MS47

1. Unpack the imager. Remove cable retention clip by pinching the top edges of the clip and sliding away from the imager.
2. Insert USB cable. Attach cable retention clip back onto the imager with the arrows on the clip pointing towards the device.

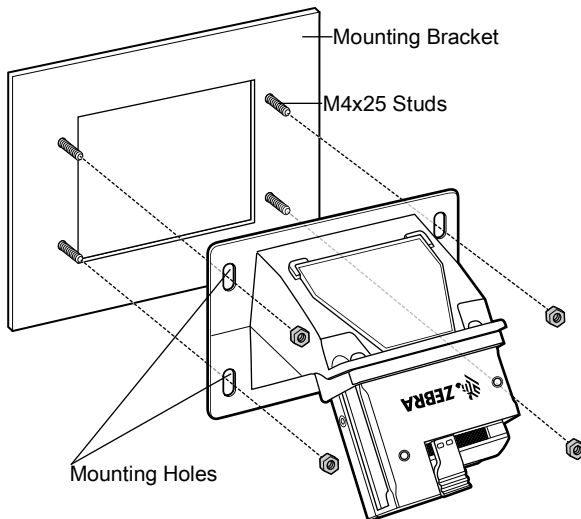


Figure 5 Installation Procedure



3. To mount the device, refer to the EVA specification for minimum space requirements: wrzutnik.com/wp-content/uploads/eva_eps_v1_1.pdf

Figure 6 Mounting MS47 Cone



4. Mount the device by aligning the four mounting holes on the device housing with the four M4x25 studs on the mounting bracket.
5. Fasten the four mounting nuts to the M4x25 studs to secure the device



NOTE: It is recommended that a Zebra USB cable is used for installation (p/n = 25-124330-01R). If other USB cables are used, they must be compatible with current USB.org requirements.

Please refer to USB.org connectors and compliance documentation for more information found here: usb.org/documents

Accessories

Zebra offers additional accessories for the MS47 through Solution Builder (ordering guide), it is recommended that this tool is used to order any accessories.



NOTE: To ensure that the USB cable will fit properly with the cable retention clip, it is recommended that the connector shell size does not exceed 11.5 mm (w) and 8.7 mm (thickness). The width cannot exceed 12.5 w and 10.5 thickness. The cable connector shell length cannot exceed 17 mm.

Location and Positioning

The location and positioning guidelines do not consider unique application characteristics. Zebra recommends that an opto-mechanical engineer perform an opto-mechanical analysis prior to integration.



NOTE: Integrate the imager in an environment that is not more extreme than the product's specification, where the imager will not exceed its temperature range. For instance, do not mount the scanner onto or next to a large heat source. When integrating the imager within another device, ensure there is proper convection or venting for heat. Follow these suggestions to ensure product longevity, warranty, and overall satisfaction with the scanner.

Embedded Applications Requiring a Window

Use the following guidelines for applications that require a window in front of the imager.



NOTE: Zebra does not recommend placing an exit window in front of the imager; however, the following information is provided for applications that require such a window.

Window Material

Many window materials that look clear can contain stresses and distortions that reduce performance. For this reason, use only cell-cast plastics or optical glass (with or without an anti reflection coating, depending on the application). Following are descriptions of three popular window materials: PMMA, ADC (CR-39™), and chemically tempered glass. Table 1 outlines the suggested window properties.

Table 1 Suggested Window Properties

Property	Description
Thickness	Typically 0.03 - 0.06 in. (0.7 - 1.5 mm)
Wavefront Distortion (transmission)	0.2 wavelengths peak-to-valley maximum and 0.04 maximum rms over any 0.08 in. diameter within the clear aperture
Clear Aperture	To extend to within 0.04 in. of the edges all around
Surface Quality	60-20 scratch/dig

When using plastic materials pay extra attention to the wavefront distortion recommendation specified above. Plastic materials are not recommended for tilted windows since surface scratches cause image artifacts. Colored windows are not recommended if motion detection mode is required since it reduces engine sensitivity to the moving target.

Cell Cast Acrylic (ASTM: PMMA)

Cell Cast Acrylic, or Poly-methyl Methacrylic (PMMA) is fabricated by casting acrylic between two precision sheets of glass. This material has very good optical quality, reasonably good impact resistance and low initial cost, but is relatively soft and susceptible to attack by chemicals, mechanical stresses, and UV light. Therefore polysiloxane coating is strongly recommended. Acrylic can be laser cut into odd shapes and ultrasonically welded.

Cell Cast ADC (ASTM: ADC)

Also known as CR-39™, Allyl Diglycol Carbonate (ADC) is a thermal-setting plastic produced by cell-casting. Most plastic eyeglasses sold today are uncoated, cell-cast CR-39. This material has excellent chemical and environmental resistance, and reasonably good impact resistance. It also has quite good surface hardness, and therefore does not have to be hard-coated, but may be coated for severe environments. This material cannot be ultrasonically welded.

Chemically Tempered Glass

Glass is a hard material that provides excellent scratch and abrasion resistance. However, unannealed glass is brittle. Increasing flexibility strength with minimal optical distortion requires chemical tempering. Glass cannot be ultrasonically welded and is difficult to cut into odd shapes.

Commercially Available Coatings

Anti-Reflection Coatings

Anti-reflection coatings can be used for stray light control or to achieve maximum working range, and can be applied to the inside and/or outside of the window to reduce the amount of light reflected off the window back into the engine. However, they are expensive and have very poor abrasion and scratch resistance.

Polysiloxane Coating

Polysiloxane type coatings are applied to plastic surfaces to improve the surface resistance to both scratch and abrasion. To apply, dip and air dry in an oven with filtered hot air.

To gauge a window's durability, use ASTM standard D1044, Standard Test Method for Resistance of Transparent Plastics to Surface Abrasion (the Taber Test), which quantifies abrasion resistance as a percent increase in haze after a specified number of cycles and load. Lower values of the increase in haze correspond to better abrasion and scratch resistance. See [Table 2](#).

Table 2 Taber Test Results on Common Exit Window Materials

Sample	Haze 100 cycles	Haze 500 cycles	Abrasion Resistance
Chemically Tempered Glass	1.20%	1.50%	Best
PMMA with Polysiloxane Hardcoat	3%	10%	
ADC	5%	30%	
PMMA	30%		Worst
* All measurements use a 100 gram load and CS-10F Abraser.			

A Word About Coatings

If using an anti-reflective (AR) coating, the specifications in [Table 3](#) apply. Polysiloxane coating is not required. Recess the exit window to minimize scratches and digs.

Table 3 AR Coatings Specifications

Specification	Description
Material	Both tempered glass and plastic (e.g., CR-39 or hard coated acrylic) exit windows can be AR coated. AR coated glass is easier and more durable because of a better adhesion property on the glass structure. In addition, it can be more cost effective to put an AR coating on the glass substrate rather than on the plastic.
AR Coating Specification	<ul style="list-style-type: none"> • Single side AR-coating: 92% minimum transmittance within spectrum range from 420 nm to 730 nm. • Double side AR-coating: 97% minimum transmittance within spectrum range from 420 nm to 730 nm. • For parallel windows, see Figure 10 on page 36.

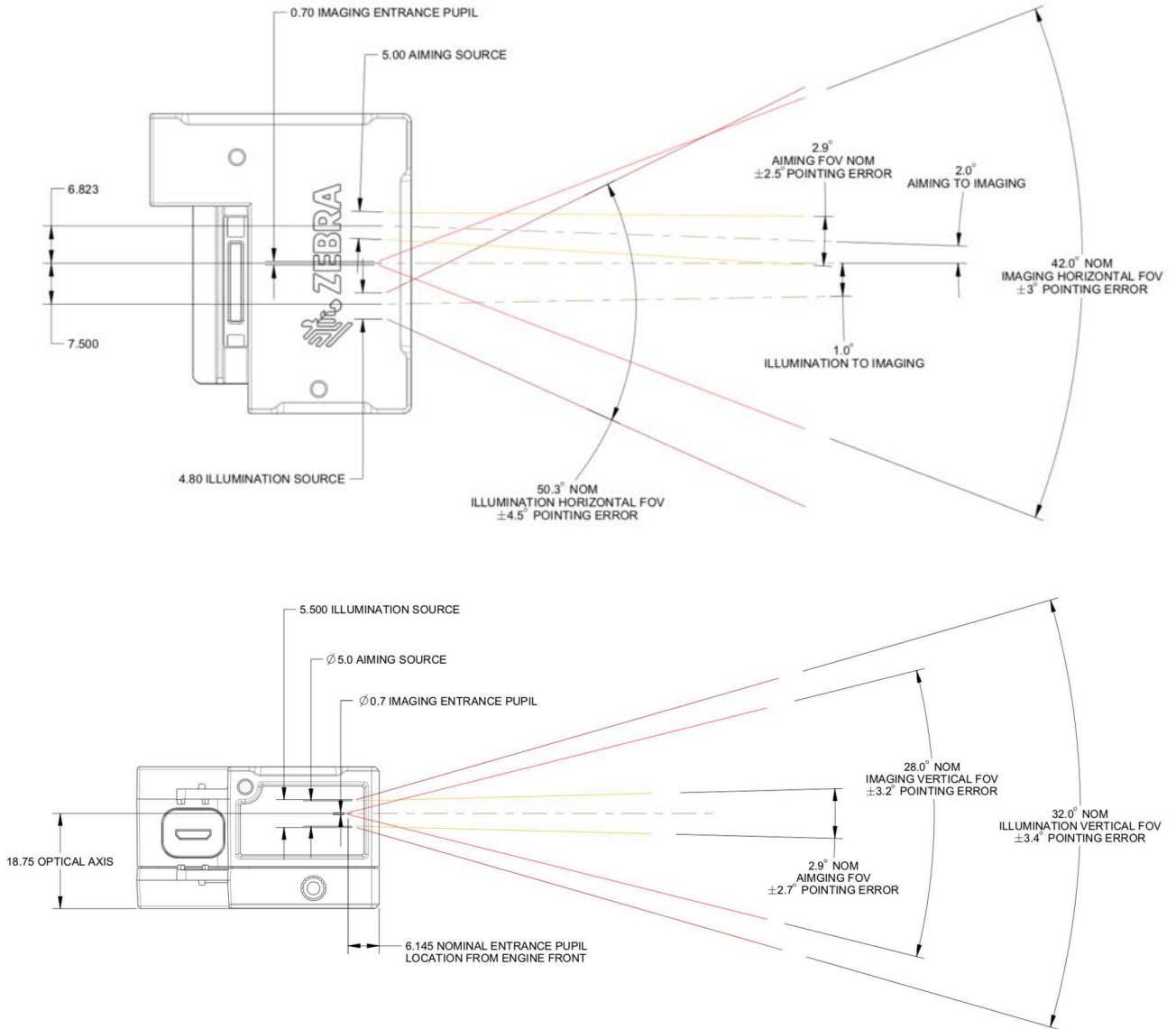
Embedded Window Angle and Position

If you are placing a window between the imager and the target, observe the following guidelines:

- **Window Clear Opening** - Make the clear opening of the window large enough so that the entire imager clear aperture passes through the window. Cutting off any part of the clear aperture can degrade decode range performance. Ensure that window placement relative to the imager accounts for tolerances on all parts involved in that assembly.
- **Window Angle** - Minimum window tilt is indicated in [Table 4](#). Further tilting the window is acceptable and decreases the possibility of a secondary reflection from that window degrading the scanner's performance.
- **Minimum Window Distance** - See [Table 4](#).
- **Optical Working Range** - Adding a window can reduce the working range of the scanner since there is a signal loss when passing through window material. To minimize this reduction, use a special coating described in [A Word About Coatings on page 32](#). To understand the difference, test the scanner in the desired orientation and see if the difference affects scanner performance.

MS4717 Optical Path

Figure 7 MS4717 Optical Path and Exit Window

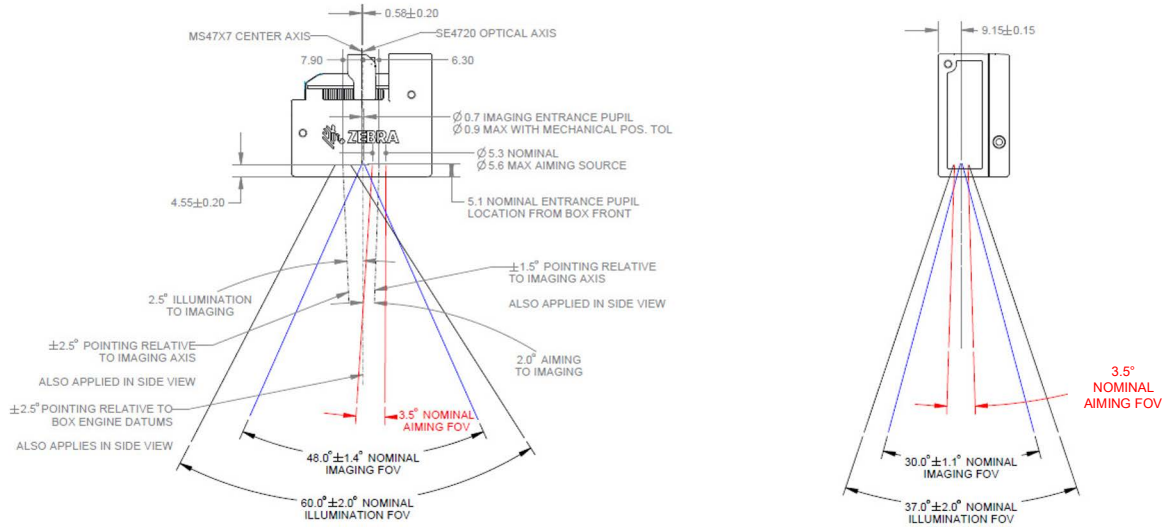


Notes:

1. Imaging axis pointing tolerance vs. datums ABC:
± 3° horizontal; ± 3.2° vertical
2. Clipping the scanner clear aperture is not permitted.
3. Dimensions are in mm.

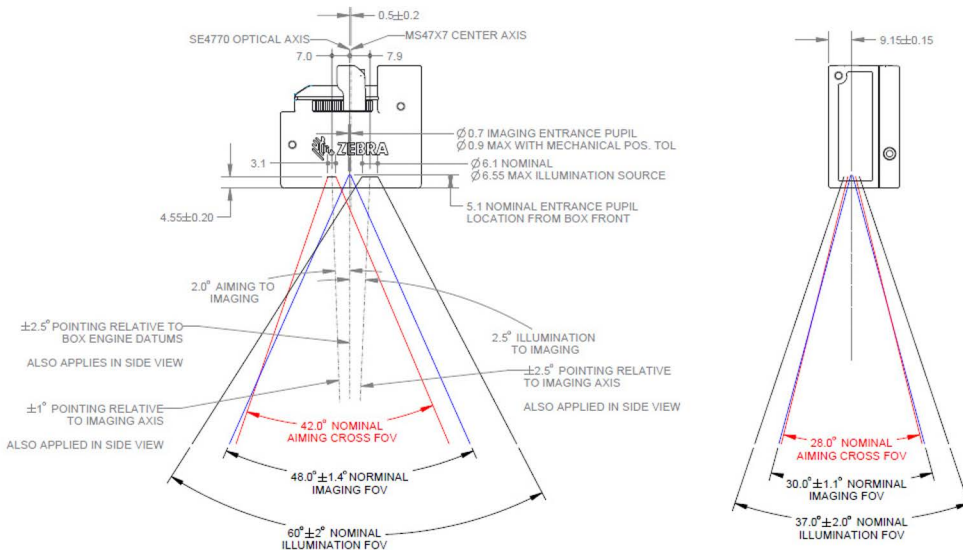
MS4727 Optical Path

Figure 8 MS4727 Optical Path and Exit Window



MS4777 Optical Path

Figure 9 MS4777 Optical Path and Exit Window



MS47 Recommended Exit Window Information

Figure 10 Exit Window Distance Information

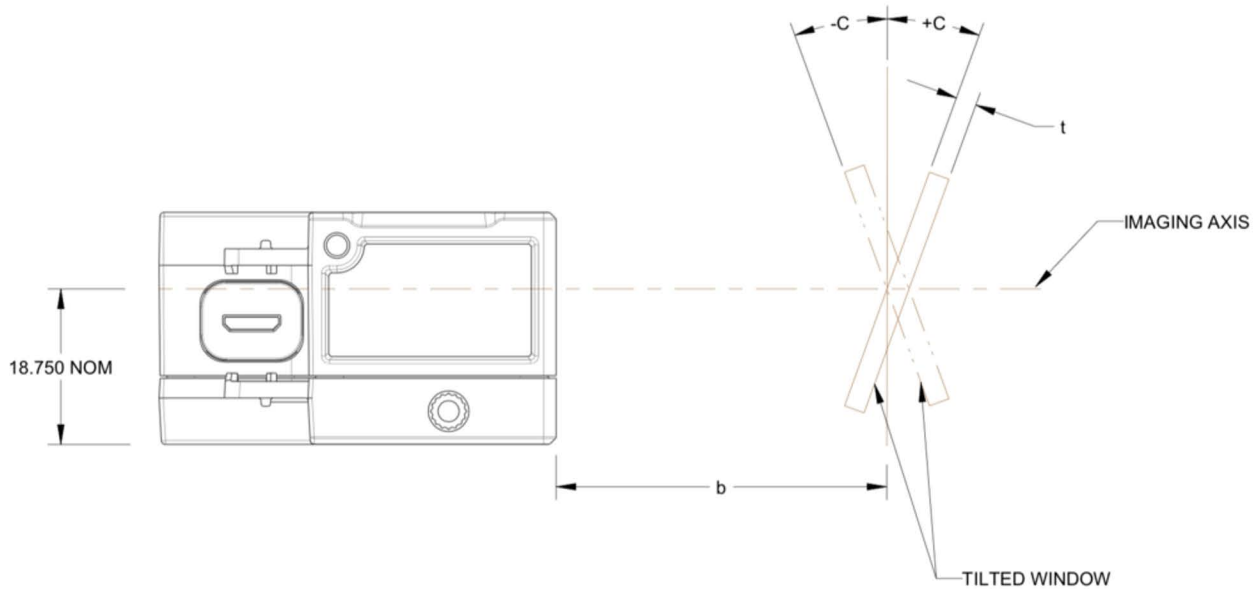


Table 4 Recommended Exit Window Information - Tilted Window

Minimum Angle for Tilted Window	Distance from Engine Front Surface (b) in mm				
	5mm	10mm	15mm	20mm	25 mm
Non-coated, minimum window positive tilt (+c)	-	50°	50°	50°	50°
Non-coated, minimum window negative tilt (-c)	-	50°	50°	50°	50°
AR coated, one side, minimum window positive tilt (+c)	-	45°	45°	45°	45°
AR coated, one side, minimum window negative tilt (-c)	-	45°	45°	45°	45°
AR coated, two sides, minimum window positive tilt (+c)	40°	40°	40°	40°	35°
AR coated, two sides, minimum window negative tilt (-c)	40°	40°	40°	40°	35°

Exit Window Notes

- Integration tolerances are not included.
- Ensure the window size is large enough to cover the engine clear aperture plus mounting tolerances of the window relative to the engine.

MS4717 Cone Optical Path

Figure 11 MS4717 Cone Optical Path - Horizontal

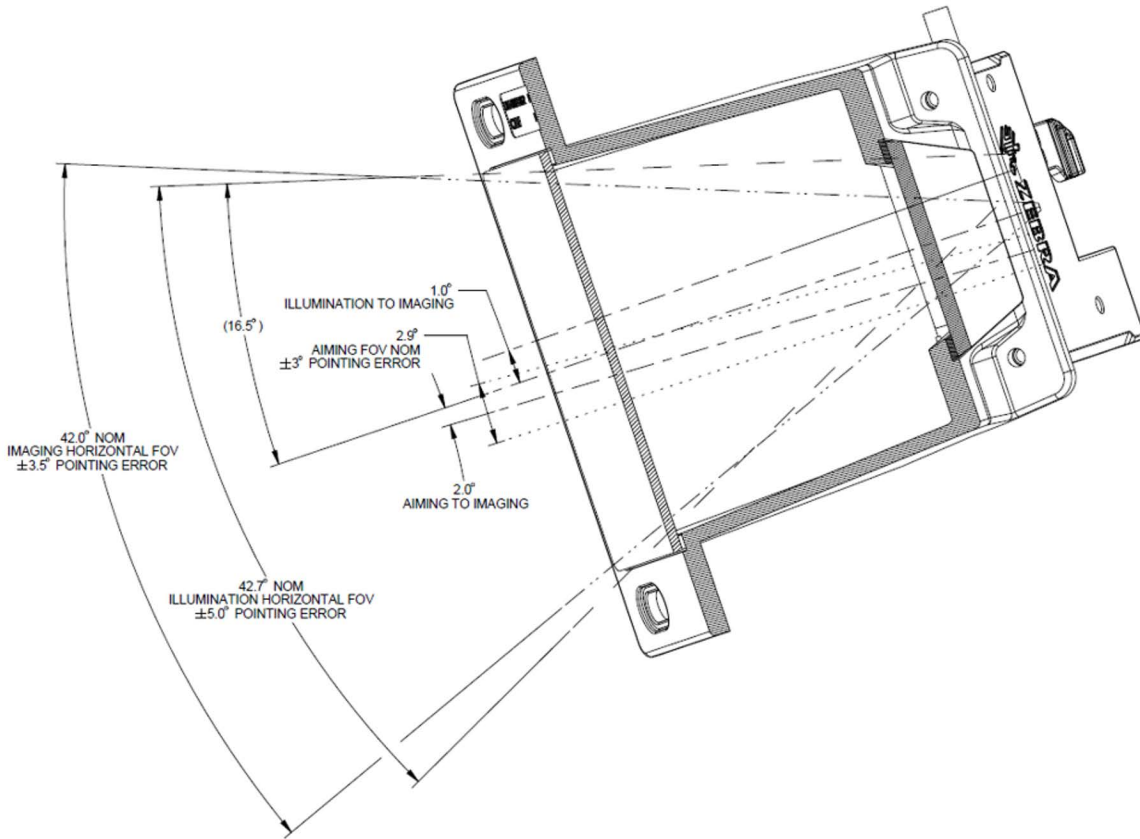
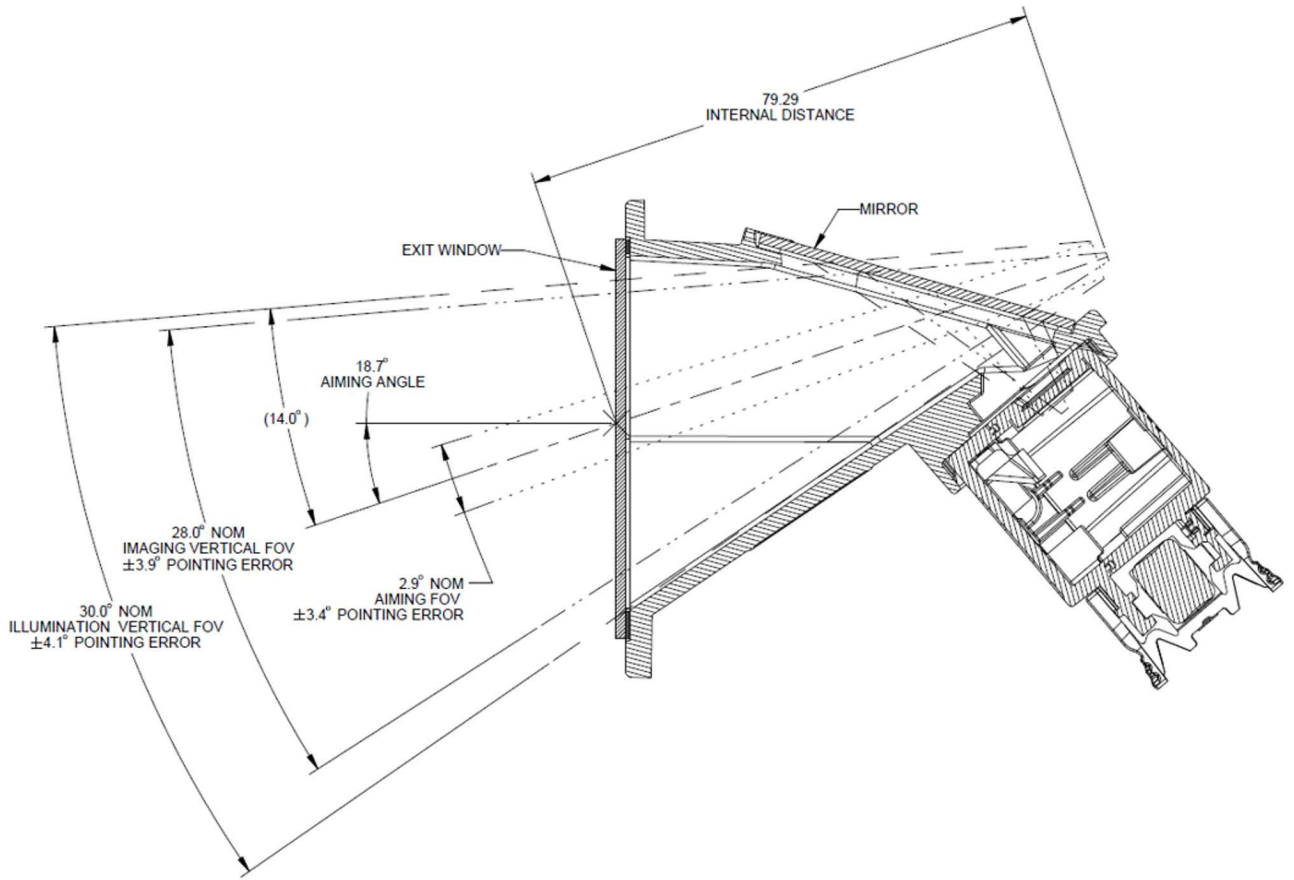
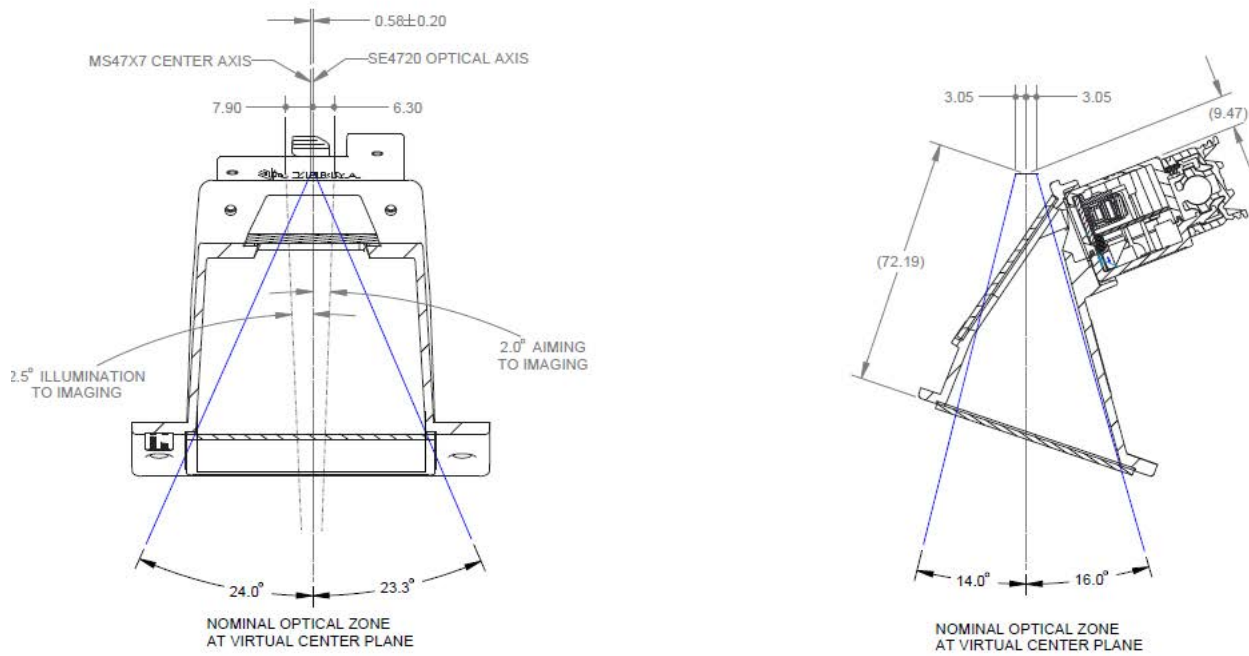


Figure 12 MS4717 Cone Optical Path - Vertical



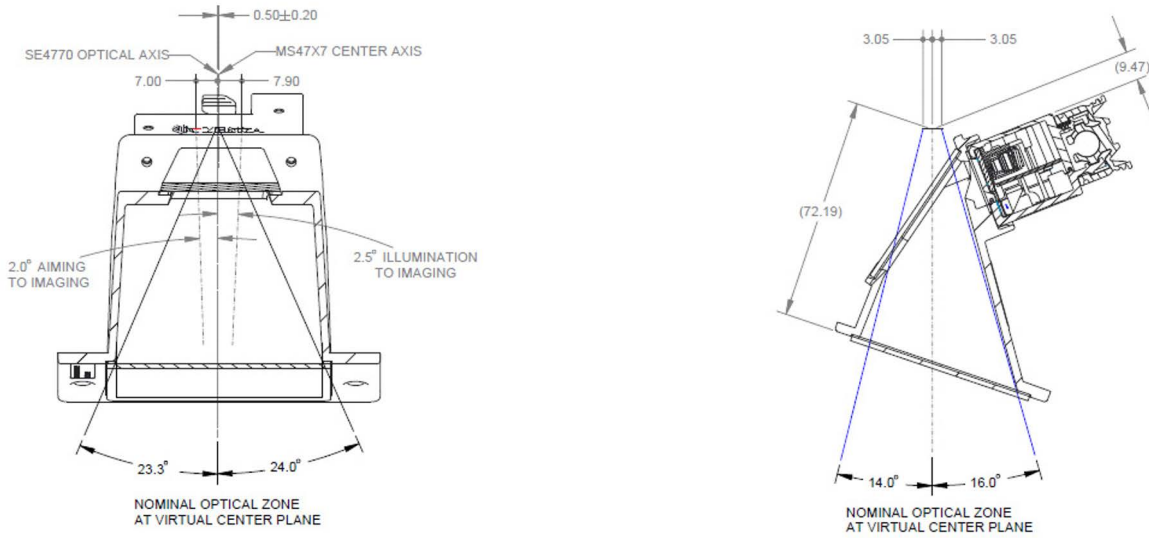
MS4727 Cone Exit Window Optical Zone

Figure 13 MS4727 Cone Imaging Optical Zone at Exit Window



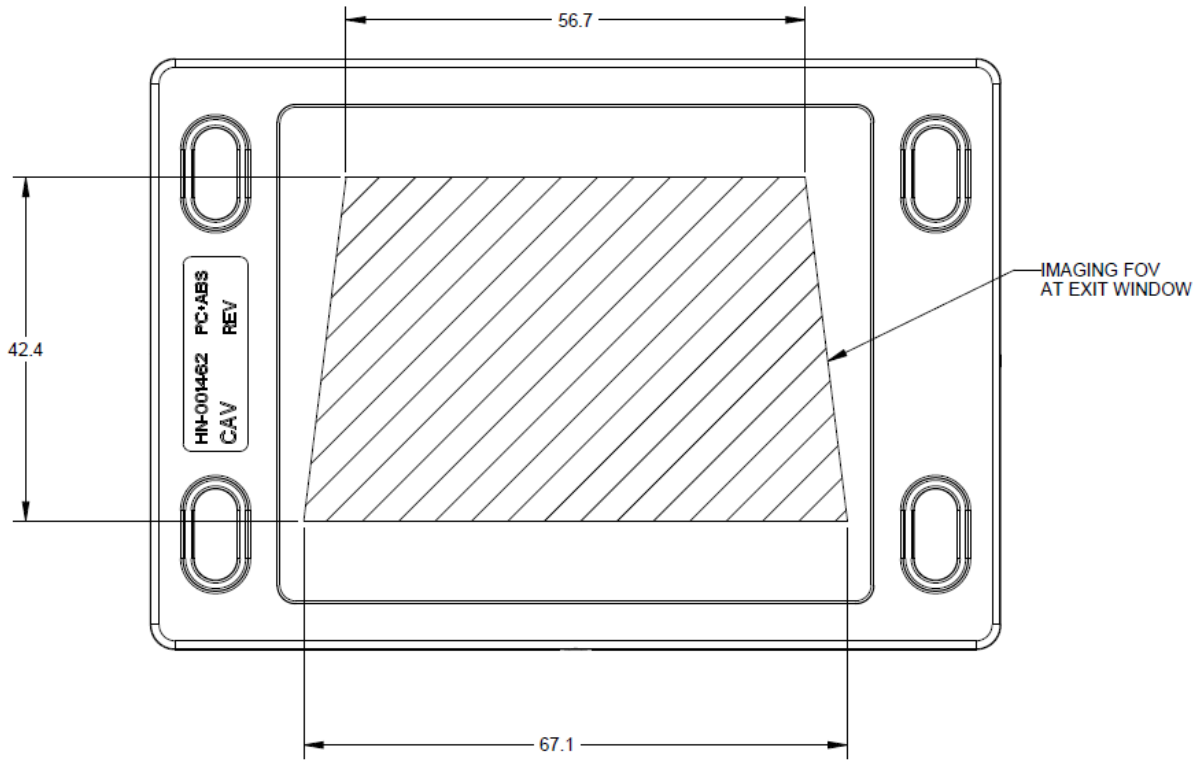
MS4777 Cone Exit Window Optical Zone

Figure 14 MS4777 Cone Imaging Optical Zone at Exit Window



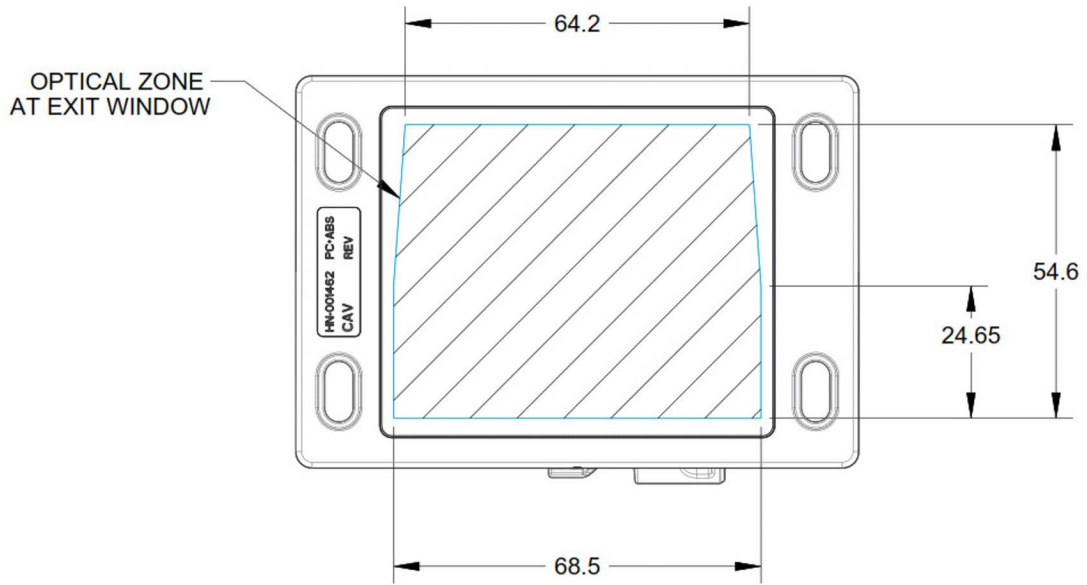
MS4717 Cone Exit Window Optical Zone

Figure 15 MS4717 Cone Optical Zone at Exit Window



MS4727/MS4777 Cone Exit Window Optical Zone

Figure 16 MS4727/MS4777 Cone Optical Zone at Exit Window



Zebra SNAPI Software Developer's Kit

The Symbol Native Application Programming Interface Software Development Kit (SNAPI SDK) facilitates communication with SNAPI-based Zebra scanners over USB, providing the following features:

- Barcode capture and decode
- Image and video capture
- Electronic scanner configuration and software update
- Reference sample application in Microsoft Visual C#[®] .NET.

To download the SDK, go to: zebra.com/support

Scanning

Introduction

This chapter provides information on aiming, illumination, data capture, beeper and decode LED feedback, supported symbologies, and operating modes.

Imaging System

Aiming System

For the MS4717, an amber 610 nm LED is used to generate a circular aiming pattern which indicates the center of the imager's field of view.

For the MS4727, a green 525 nm LED is used to generate a circular aiming pattern which indicates the center of the imager's field of view.

For the MS4777, a red 655 nm laser aimer is used to generate a crosshair aiming pattern which indicates the center of the imager's field of view.

Aiming with MS47

When scanning, the device projects an aiming pattern which allows positioning the barcode within its field of view. If necessary, the imager turns on its LEDs to illuminate the target barcode.

To scan a barcode, center the symbol and ensure the entire symbol is within the rectangular area formed by the illumination LEDs. The imager can also read a barcode presented within the aiming pattern when off-centered. The figure below illustrates proper LED placement to produce a successful decode.

Figure 17 MS4717/MS4727 Aiming Pattern

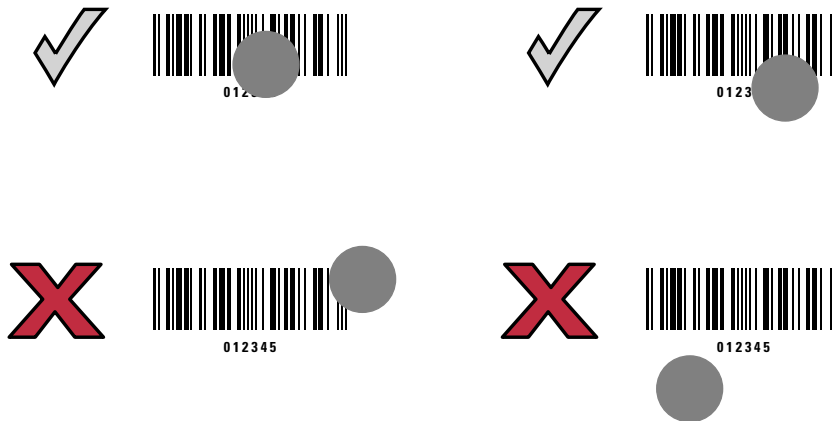
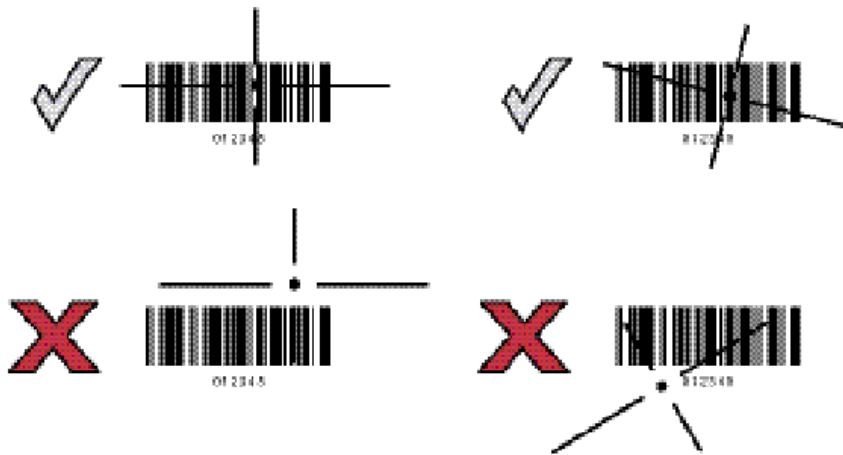


Figure 18 MS4777 Aiming Pattern



Aiming Error

The aiming pattern is rotated by 2° relative to the imaging axis in the horizontal plane to minimize parallax between the aiming axis and the imaging axis at 190.45 mm (7.5 in.) from the front of the device.

Aiming Control

The MS47 series can capture images with both the aiming subsystem turned on during exposure (the image of the aiming pattern is visible in the digital image) or off. If the aiming system is turned off during exposure, brightness of the aiming pattern decreases as exposure increases.

The aiming subsystem can also be turned off completely. Zebra recommends shutting aiming off three frames prior to capturing documents to prevent the aiming pattern from appearing faintly in captured images. Note that this is not necessary for barcode decoding.

Illumination System

The illumination system consists of one red LED (MS4717) or a white LED (MS4727/MS4777) and a sophisticated drive system that allows image capture and decoding throughout a full range of lighting conditions (total darkness to full sunlight).

Illumination Control

The MS47 series can capture images with the illumination subsystem turned on or off. LED illumination can be turned off when taking images of documents printed on semi-glossy or glossy paper or on a substrate with security marks. In this case, ensure ambient illumination provides a minimum of 30 fcd on the document surface.

Supported Symbologies

The following barcode types are supported and can be individually enabled or disabled:

1D Symbologies

UPC/EAN
 Bookland EAN
 UCC Coupon Code
 ISSN EAN
 Code 128
 GS1-128
 ISBT 128
 Code 39
 Trioptic Code 39
 Code 32
 Code 93
 Code 11
 Interleaved 2 of 5
 Discrete 2 of 5
 Codabar
 MSI
 Chinese 2 of 5
 Matrix 2 of 5
 Korean 3 of 5
 Inverse 1D
 GS1 DataBar
 Composite Codes

2D Symbologies

PDF417
 MicroPDF417
 Data Matrix, Data Matrix Inverse
 GS1 Data Matrix
 Maxicode
 QR Code
 GS1 QR
 MicroQR
 Aztec, Aztec Inverse
 Han Xin, Han Xin Inverse
 Grid Matrix, Grid Matrix Inverse, Grid Matrix Mirrored

Postal Codes

US Postnet
 US Planet
 UK Postal
 Japan Postal
 Australia Post
 Netherlands KIX Code
 USPS 4CB/One Code/Intelligent Mail
 UPU FICS Postal
 Mailmark

Operating Modes

The MS47 supports the following operating modes.

- Decode (default mode) - for decoding a barcode.
- Snapshot - for capturing an image.
- Snapshot with Viewfinder Mode - provides a video of the subject until a snapshot of the image is captured.
- Video - provides a video of the subject.

Specifications

MS47 Series Fixed Mount Imager Technical Specifications

This chapter provides information regarding the imager's technical specifications, as well as skew, pitch, and roll information, and decode zones.

Table 5 MS47 Technical Specifications

Item	Description
Physical Characteristics	
Dimensions	1.10 in. H x 2.17 in. W x 1.89 in. D (2.8 cm H x 5.5 cm W x 4.8 cm D) With Cone: 2.98 in H x 4.13 in W x 4.04 in D (7.59cm H x 10.5cm W x 10.25cm D)
Weight	3.92 oz/111 g +/- 5% With Cone: 6.67 oz/189 g +/- 5%
Power	MS4717: Maximum: 5 VDC +/- 10% @ 480 mA MS4727/MS4777: Maximum: 5 VDC +/- 5% @ <500 mA MS4727/MS4777: Maximum: 5 VDC +/- 10% @ <530 mA
User Environment	
Operating Temperature	MS4717: -4° to 122° F /-20° to 50° C MS4727: -22° to 131° F /-30° to 55° C MS4777: -22° to 131° F /-30° to 55° C
Storage Temperature	-40° to 158° F /-40° to 70° C
Operating Humidity	95% RH, non-condensing at 50°C
Storage Humidity	MS4717: 85% RH, non-condensing at 70°C MS4727/MS4777 with cone: 85% RH, non-condensing at 70°C MS4727/MS4777 without cone: 95% RH, non-condensing at 55°C
Sealing (non-cone version only)	IP54
Drop Specification	Non-cone scanner designed to withstand multiple drops at 5.0 ft./1.5 m to concrete at room temperature

Specifications

Table 5 MS47 Technical Specifications

Item	Description
Exit Window (Cone)	2.87 in. L x 2.4 in. W x .06 in. D, .04 in/.1cm corner radius (7.3 cm L x 6.10 cm W x .15 cm D)
Integration (Cone)	4 forward-facing mounting holes, EVA Compliant
Performance Characteristics	
Image Sensor	1280 x 800 pixels
Imager Field of View	MS4717: 42° H x 28° V Nominal (cone: 42° H x 28° V) MS4727/MS4777: 48° H x 30° V Nominal (cone: 47.3° H x 30° V)
Light Source	Aiming Pattern: MS4717: Circular 610nm Amber LED MS4727: Circular 525nm Green LED MS4777: Cross-hair 655nm Red Laser Illumination: MS4717: 660nm Red LED MS4727/MS4777: White LED
Minimum Print Contrast	20% minimum reflective difference
OCR Capability	OCR-A, OCR-B, MICR E13B, US Currency Serial Number
Regulatory	
Product Safety	IEC/EN 62368-1, UL/cUL 62368-1
Laser Classification	MS4777: Class 2 per IEC 60825-1:2014
LAMP Standard	LED / Classified as Exempt Risk Group per IEC/EN 62471
EMI/RFI	FCC Part 15 Class B, CISPR32 Class B, EN 55032, EN 55035, ICES-003 Issue 7 Class B, IEC 60601-1-2 Medical Electrical Equipment, IEC 61000-6-2 Industrial (MS4727/MS4777)
Environmental	RoHS compliant
Supported Interfaces	USB - USB (full speed)
USB Certification	USB 2.0 Full Speed Compliant, visit USB.org for more details



NOTE: Environmental and/or tolerance parameters are not cumulative. Zebra recommends a thermal analysis if the application is subject to an extreme temperature environment.

MS4777 Regulatory Considerations

The MS4777 meets the accessible laser light limits for a CDRH/IEC Class 2 laser and an exempt risk group LED product. Any product containing the MS4777 can meet these same regulations. Contact a Zebra sales representative for further details.

Laser products sold in North America must be reported to the U.S. Food and Drug Administration, Center for Devices and Radiological Health (CDRH) via a Laser Radiation Safety Report (Product Report). Visit fda.gov for additional information.

Refer to the U.S. Code of Federal Regulations, 21CFR1040.10 for the specific North American requirements for laser products. For devices intended for international sales, refer to the IEC/EN60825-1 standard for the Safety of Laser Products.

Complies with 21 CFR1040.10 and 1040.11 except for deviations pursuant to Laser Notice No. 56, dated May 08, 2019 and IEC/EN 60825-1:2014.

Required Documentation for Class 2 Laser Products

The MS4777 device:

- Complies with 21CFR1040.10 and 1040.11 except for deviations pursuant to Laser Notice No. 56, dated May 8, 2019.
- EN60825-1:2014/A11:2021
- IEC 60825-1:2014 (Ed. 3.0)

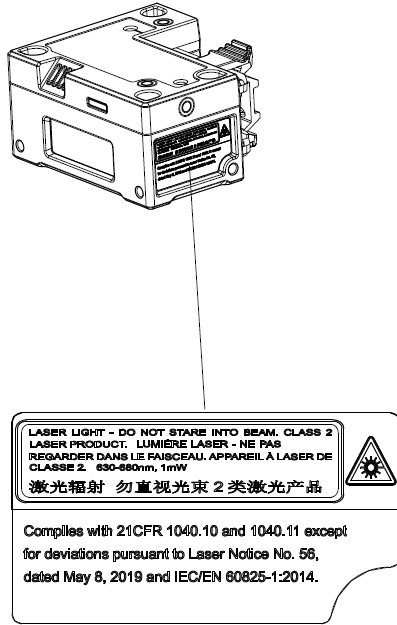
Class 2 laser scanners use a low power, visible light diode. As with any very bright light source, such as the sun, the user should avoid staring directly into the light beam. Momentary exposure to a Class 2 laser is not known to be harmful.



CAUTION: The use of controls, adjustments or performance of procedures other than those specified herein may result in hazardous laser light exposure.

A copy of the product's laser safety label, such as the one below, should appear in the product documentation, depending on the end product. Refer to the current applicable laser safety standards for the end product or specific requirements.

Figure 19 Class 2 Laser Warning Label Placement



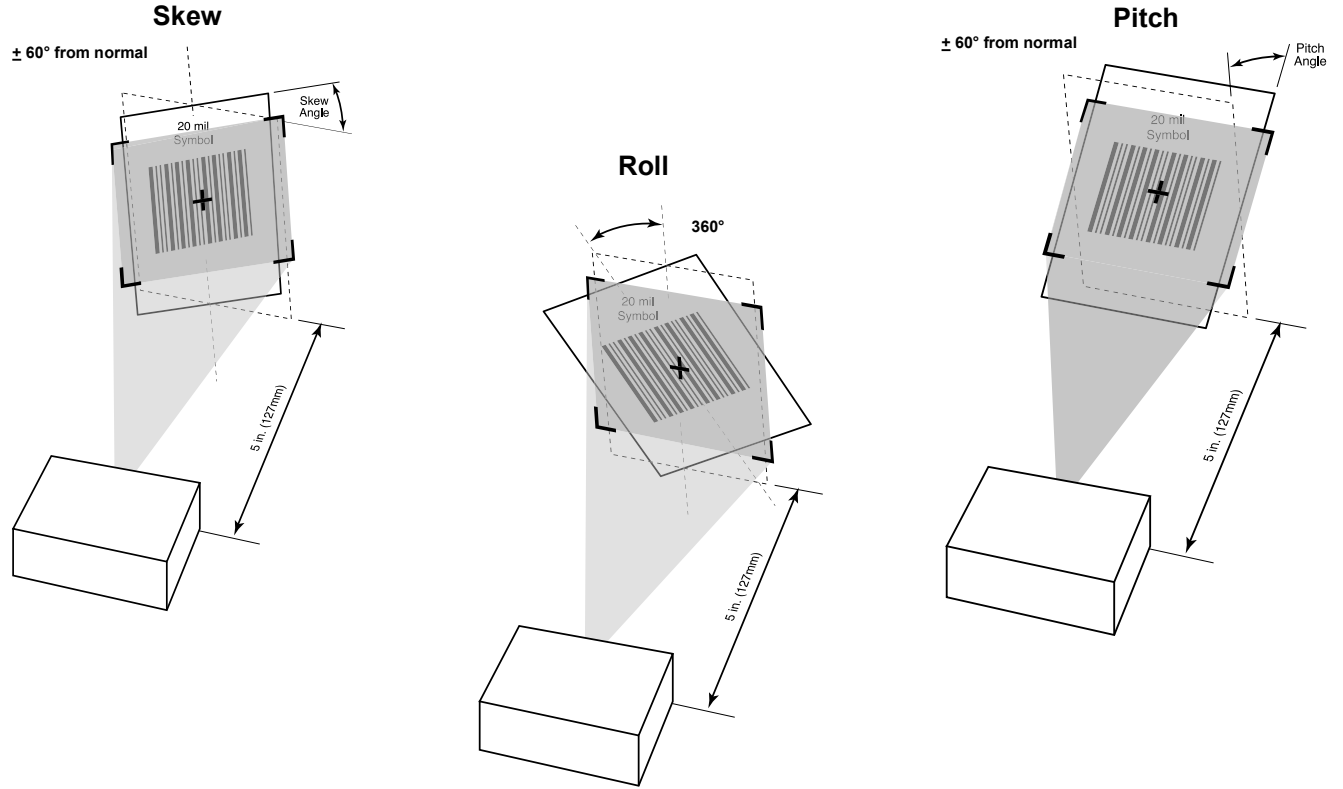
Required Documentation for All End Products

The documentation should contain a diagram showing the location of the laser aperture and warning statement as shown in the example above.

Skew, Pitch and Roll

Measured on a 20 mil Code 39 symbol at a distance of 10 inches. Tolerance is reduced at extreme ends of the working range.

Figure 20 Skew, Pitch and Roll



MS4717 Decode Zones

Table 6 MS4717 Decode Ranges

Symbol Density/ Barcode Type	Typical Working Range for MS4717		Typical Working Range for MS4717 with Cone	
	Near	Far	Near	Far
4 mil Code 39	3.1 in / 7.8 cm	8.6 in / 21.8 cm	0.2 in / 0.50 cm	5.5 in / 14.0 cm
5 mil Code 128	2.6 in / 6.6 cm	8.0 in / 20.3 cm	0 in / 0 cm	5.0 in / 12.7 cm
5 mil Code 39	1.8 in / 4.6 cm	12.4 in / 31.5 cm	0 in / 0 cm	9.3 in / 23.6 cm
5 mil PDF417	2.9 in / 7.4 cm	8.2 in / 20.2 cm	0.1 in / 0.25 cm	4.7 in / 11.9 cm
10 mil Data Matrix	2.7 in / 6.9 cm	9.9 in / 25.1 cm	0 in / 0 cm	6.7 in / 17.0 cm
100% UPCA Data Matrix	1.6 in / 4.1 cm	25.8 in / 65.5 cm	0 in / 0 cm	17.0 in / 43.2 cm
20 mil Code 39	2.2 in / 5.6 cm	29.8 in / 75.7 cm	0 in / 0 cm	19.1 in / 48.5 cm
20 mil QR Code	3.0 in / 7.6 cm	15.6 in / 39.6 cm	0 in / 0 cm	12.4 in / 31.5 cm
Notes: Near distances are field-of-view (FOV) limited.				

MS4727/MS4777 Decode Zones

Table 7 MS4727/MS4777 Decode Ranges

Symbol Density/ Barcode Type	MS4727/MS4777 (Without Cone)		MS4727/MS4777 (With Cone)	
	Near	Far	Near	Far
3 mil Code 39	2.8 in / 7.1 cm	5.6 in / 14.2 cm	0 in / 0 cm	2.8 in / 7.1 cm
5 mil Code 128	2.1 in / 5.3 cm	9.6 in / 24.3 cm	0 in / 0 cm	6.8 in / 17.3 cm
5 mil PDF417	2.8 in / 7.1 cm	7.7 in / 19.6 cm	0 in / 0 cm	4.9 in / 12.4 cm
6.67 mil PDF417	2.3 in / 5.8 cm	9.9 in / 25.1 cm	0 in / 0 cm	7.1 in / 18.0 cm
10 mil Data Matrix	1.9 in / 4.8 cm	10.8 in / 27.4 cm	0 in / 0 cm	8.0 in / 20.3 cm
100% UPCA	1.6* in / 4.0 cm	24.7 in / 62.7 cm	0 in / 0 cm	21.9 in / 55.6 cm
15 mil Code 128	2.4* in / 6.0 cm	27.6 in / 70.1 cm	0 in / 0 cm	24.8 in / 63 cm
20 mil Code 39	1.6* in / 4.0 cm	35.9 in / 91.2 cm	0 in / 0 cm	33.1 in / 84 cm
20 mil QR Code	0.9* in / 2.3 cm	17.3 in / 44 cm	0 in / 0 cm	14.0 in / 36 cm

Note: Near distances are field-of-view (FOV) limited.

Maintenance and Troubleshooting

Introduction

The chapter provides information on maintenance and troubleshooting, as well as beeper and LED indications.

Maintenance

Clean the imager housing and exit window with a damp cloth and, if necessary, a non-ammonia based detergent. Do not allow any abrasive material to touch the exit window.

Troubleshooting

Table 8 Troubleshooting

Problem	Possible Cause	Possible Solutions
No green LED or nothing happens during a capture attempt.	No power to the imager.	Check the system power. Confirm that the correct host interface cable is used.
		Re-connect loose cables.
Imager cannot read the barcode.	Imager is not programmed for the correct barcode type.	Program the scanner to read the type of barcode to be decoded.
	Barcode symbol is unreadable.	Ensure the symbol is not defaced. Try capturing similar symbols of the same code type.
Aiming pattern does not appear.	Hot environment.	Remove the imager from the hot environment, and allow it to cool down.
LED activates, followed by a beep sequence.	Beeper is configured.	See Supported Symbologies on page 46 for beeper indication descriptions.

Beeper and LED Indication

Table 9 LED Indications

Indication	Beeper	LED
Reader is on.	N/A	Green
A barcode was successfully decoded.	1 beep	Green flash.
A programming parameter was entered successfully.	Fast warble	Green flash.

User Preferences

Introduction

This chapter describes each user preference feature and provides the programming barcodes necessary for selecting these features.

You can program the imager to perform various functions, or activate different features. This chapter describes each user preference feature and provides programming barcodes for selecting these features.

The imager ships with the settings shown in [Table 10](#) (also see [Standard Default Parameters](#) for all defaults). If the default values suit requirements, programming is not necessary.

To set feature values, scan a single barcode or a short barcode sequence. The settings are stored in non-volatile memory and are preserved even when the digital scanner is powered down.



NOTE: Most computer monitors allow scanning the barcodes directly on the screen. When scanning from the screen, be sure to set the document magnification to a level where you can see the barcode clearly, and bars and/or spaces are not merging.

If not using a USB cable, select a host type (see each host chapter for specific host information) after the power-up beeps sound. This is only necessary upon the first power-up when connected to a new host.

To return all features to default values, see [Default Parameters on page 59](#). Throughout the programming barcode menus, asterisks indicate (*) default values.



* Indicates Default — * **High Volume** — Feature/Option
(0) — Option Value

Scanning Sequence Examples

In most cases, scanning one barcode sets the parameter value. The imager issues a fast warble beep and the LED turns green, signifying a successful parameter entry.

Other parameters require scanning several barcodes. See these parameter descriptions for this procedure.

Errors While Scanning

Unless otherwise specified, to correct an error during a scanning sequence, just re-scan the correct parameter.

User Preferences Parameter Defaults

Table 10 lists defaults for user preferences parameters. To change the default values:

- Scan the appropriate barcodes in this guide. These new values replace the standard default values in memory.
- Configure the imager using the 123Scan² configuration program.



NOTE: See [Standard Default Parameters](#) for all user preferences, hosts, symbologies, and default parameters.

Table 10 User Preferences Parameter Defaults

Parameter	Parameter Number ¹	SSI Number ²	Default	Page Number
User Preferences				
Set Default Parameter	N/A	N/A	Restore Defaults	59
Parameter Barcode Scanning	236	ECh	Enable	60
Beep After Good Decode	56	38h	Enable	61
Beep on <BEL>	150	96h	Enable	61
Lock/Unlock	802/803	F2h 22h/ F2h 23h	N/A	62
Beeper Volume	140	8Ch	High	63
Beeper Tone	145	91h	Medium	64
Beeper Duration	628	F1h 74h	Medium	65
Suppress Power Up Beeps	721	F1h D1h	Do Not Suppress	65
Trigger Mode	138	8Ah	Presentation Mode	66
Presentation Decode Aiming Pattern	590	F1h 4Eh	Enable	67
Picklist Mode	402	F0h 92h	Disabled Always	68

1. Parameter number decimal values are used for programming via RSM commands.
2. SSI number hex values are used for programming via SSI commands.

Table 10 User Preferences Parameter Defaults (Continued)

Parameter	Parameter Number ¹	SSI Number ²	Default	Page Number
Decode Session Timeout	136	88h	9.9 Seconds	69
Hands-Free Decode Session Timeout	400	F0h 90h	15	69
Timeout Between Decodes, Same Symbol	137	89h	0.5 Seconds	71
Timeout Between Decodes, Different Symbols	144	90h	0.1 Seconds	71
Mobile Phone/Display Mode	716	F1h CCh	Disable	72
Scene Detect Mode (Wakeup)	2377	F8 09 49	Object Detect	73
PDF Prioritization	719	F1h CFh	Disable	74
PDF Prioritization Timeout	720	F1h D0h	200 msec	75
Low Light Motion Detection Assist	810	F2h 2Ah	Disable Low Light Motion Detection Assist	76
Presentation Mode Field of View	609	F1h 61h	Full	77
Scene Detect Sensitivity	1943	F8h 97h	Medium	78
Mirrored Image	624	F1h 70h	Disable	78
Decoding Illumination	298	F0h 2Ah	Enable	79
Add an Enter Key	N/A	N/A	N/A	79
Transmit Code ID Character	45	2Dh	None	80
Prefix/Suffix Values	99, 105	63h, 69h	7013 <CR><LF>	81
Suffix 1 Value	98, 104	62h, 68h	7013 <CR><LF>	81
Suffix 2 Value	100, 106	64h, 6Ah		
Scan Data Transmission Format	235	EBh	Data as is	82
FN1 Substitution Values	103, 109	67h, 6Dh	7013 <CR><LF>	83
Transmit "No Read" Message	94	5E	Disable	84
Unsolicited Heartbeat Interval	1118	F8h 04h 5Eh	Disable	85
Report Version	N/A	N/A	N/A	86
Report Decoder Manufacturing Information	N/A	N/A	N/A	86
Report Engine Manufacturing Information	N/A	N/A	N/A	86

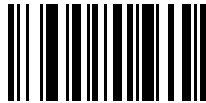
1. Parameter number decimal values are used for programming via RSM commands.
 2. SSI number hex values are used for programming via SSI commands.

User Preferences

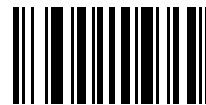
Default Parameters

The imager can be reset to two types of defaults: factory defaults or custom defaults. Scan the appropriate barcode below to reset the imager to its default settings and/or set the imager's current settings as the custom default.

- **Restore Defaults** - Resets all default parameters as follows:
 - If custom default values were configured (see **Write to Custom Defaults**), the custom default values are set for all parameters each time the **Restore Defaults** barcode below is scanned.
 - If no custom default values were configured, the factory default values are set for all parameters each time the **Restore Defaults** barcode below is scanned. (For factory default values, see [Standard Default Parameters](#).)
- **Set Factory Defaults** - Scan the **Set Factory Defaults** barcode below to eliminate all custom default values and set the imager to factory default values (For factory default values, see [Standard Default Parameters](#).)
- **Write to Custom Defaults** - Custom default parameters can be configured to set unique default values for all parameters. After changing all parameters to the desired default values, scan the **Write to Custom Defaults** barcode below to configure custom defaults.



* Restore Defaults



Set Factory Defaults



Write to Custom Defaults

Parameter Barcode Scanning

Parameter # 236 (SSI # ECh)

To disable the decoding of parameter barcodes, including the **Set Defaults** parameter barcodes, scan the **Disable Parameter Scanning** barcode below. To enable decoding of parameter barcodes, scan **Enable Parameter Scanning**.



* Enable Parameter Barcode Scanning
(1)



Disable Parameter Barcode Scanning
(0)

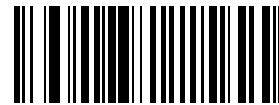
Beep After Good Decode

Parameter # 56 (SSI # 38h)

Scan a barcode below to select whether or not the imager beeps after a good decode. If selecting **Do Not Beep After Good Decode**, the beeper still operates during parameter menu scanning and to indicate error conditions.



* Beep After Good Decode (Enable)
(1)



Do Not Beep After Good Decode (Disable)
(0)

Beep on <BEL>

Parameter #150 (SSI # 96h)



NOTE: This parameter only applies to USB CDC Host.

When this parameter is enabled, the imager issues a beep when it detects a <BEL> character. <BEL> indicates an illegal entry or other important event.



* Beep on <BEL> Character (Enable)
(1)



Do Not Beep on <BEL> Character (Disable)
(0)

Lock/Unlock Parameter Scanning

Lock:

Parameter # 802

SSI # F2h 22h

Unlock:

Parameter # 803

SSI # F2h 23h

This feature locks parameter settings with a 4-digit code to prevent the user from changing parameter values by scanning parameter barcodes. This provides an added level of security not offered via **Disable Parameter Scanning**.

After locking parameter settings, the only parameter barcode that is accepted is **Unlock** with the correct code.



NOTE: [Parameter Barcode Scanning](#) must be enabled in order to scan the **Lock** parameter barcode. Once parameter scanning is locked, scanning the **Enable** or **Disable Parameter Scanning** barcode results in a parameter error beep.

To lock parameter scanning:

1. Scan the **Lock** barcode.
2. Scan four barcodes from [Numeric Barcodes](#) that represent the desired code. Enter leading zeros for numbers below 1000, e.g., to program a code of 29, enter **0, 0, 2, 9**. A "lock" beep sounds (two long high beeps) in addition to the parameter entry beep.

To unlock parameter scanning:

1. Scan the **Unlock** barcode.
2. Scan four barcodes from [Numeric Barcodes](#) that represent the correct code. An "unlock" beep sounds (two long low beeps) in addition to the parameter entry beep. Entering an incorrect code results in a parameter error beep.



Lock



Unlock

Beeper Volume

Parameter # 140 (SSI # 8Ch)

To select a beeper volume, scan the **Low Volume**, **Medium Volume**, or **High Volume** barcode.



Low Volume
(2)



Medium Volume
(1)



*** High Volume**
(0)

Beeper Tone

Parameter # 145 (SSI # 91h)

To select a beeper tone, scan one of the following barcodes.



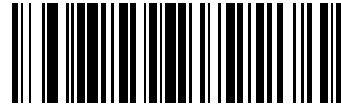
Off
(3)



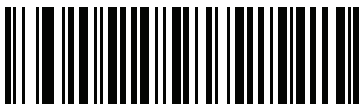
Low Tone
(2)



* Medium Tone
(1)



High Tone
(0)

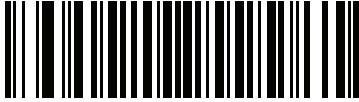


Medium to High Tone (2-tone)
(4)

Beeper Duration

Parameter # 628 (SSI # F1h 74h)

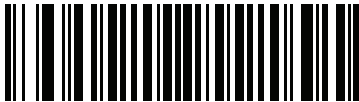
To select the duration for the beeper, scan one of the following barcodes.



**Short
(0)**



*** Medium
(1)**



**Long
(2)**

Suppress Power Up Beeps

Parameter # 721 (SSI # F1h D1h)

Scan a barcode below to select whether or not to suppress the imager's power-up beeps.



*** Do Not Suppress Power Up Beeps
(0)**



**Suppress Power Up Beeps
(1)**

Trigger Mode

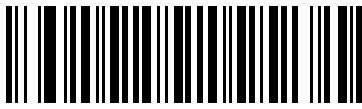
Parameter # 138 (SSI # 8Ah)



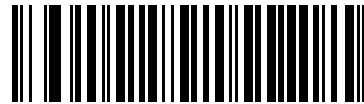
NOTE: 1. Before selecting Host trigger mode, see the USB CDC Host and HID Keyboard Emulation notes warning in [USB Device Type on page 116](#).

Select one of the following trigger modes for the digital scanner.

- **Host** - A start decode command from the host activates decode processing. Decode processing continues until barcode decodes, receipt of a stop decode command, or the [Decode Session Timeout on page 69](#) occurs.
- **Presentation Mode** - when the device detects an object in its field of view, it triggers and decodes.



Host
(0) Note 1



***Presentation Mode**
(7)

Presentation Decode Aiming Pattern

Parameter # 590 (SSI # F1h 4Eh)

Select **Enable Hands-free Decode Aiming Pattern** to project the aiming dot during barcode capture, **Disable Hands-free Decode Aiming Pattern** to turn the aiming dot off, or **Enable Hands-free Decode Aiming Pattern on PDF** to project the aiming dot when the imager detects a 2D barcode.



NOTE: With [Picklist Mode on page 68](#) enabled, the decode aiming dot flashes even when the **Decode Aiming Pattern** is disabled.



* **Enable Hands-free Decode Aiming Pattern**
(1)



Disable Hands-free Decode Aiming Pattern
(0)



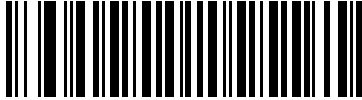
Enable Hands-free Decode Aiming Pattern on PDF
(2)

Picklist Mode

Parameter # 402 (SSI # F0h 92h)

Picklist mode enables the imager to decode only barcodes that are aligned under the LED aiming dot. Select one of the following picklist modes for the digital scanner:

- **Disabled Always** - Picklist mode is always disabled.
- **Enable Always** - Picklist mode is always enabled.



* Disabled Always
(0)



Enabled Always
(2)



NOTE: Picklist Mode temporarily overrides the Disable Decode Aiming Pattern parameter. You can not disable the decode aiming pattern when Picklist Mode is enabled.

Decode Session Timeout

Parameter # 136 (SSI # 88h)

This parameter sets the maximum time decode processing continues during a scan attempt. It is programmable in 0.1 second increments from 0.5 to 9.9 seconds. The default timeout is 9.9 seconds.

To set a Decode Session Timeout, scan the barcode below. Next, scan two numeric barcodes from [Numeric Barcodes](#) that correspond to the desired on time. Enter a leading zero for single digit numbers. For example, to set a Decode Session Timeout of 0.5 seconds, scan the barcode below, then scan the **0** and **5** barcodes. To correct an error or change the selection, scan [Cancel on page 413](#).



Decode Session Timeout

Hands-Free Decode Session Timeout

Parameter # 400 (SSI # F0h 90h)

This parameter is the Hands-free compliment to the **Decode Session Timeout**. It configures the minimum and maximum decode processing time during a Hands-free scan attempt. It only applies to the Hands-free trigger mode.

The minimum decode processing time is defined as the time in which the scanner stops decoding when an object is removed or left stationary in the imaging field of view.

The maximum decode processing time is defined as the time in which the scanner stops decoding when an object is left in or is moving in the field of view.

Both the maximum and minimum times are configured using a single setting. The relationship of this setting is as follows:

Table 11 Hands-free Decode Session Time

Setting Value	Minimum Time	Maximum Time
$X < 25$	250 ms	$X * 100$ ms
$X \geq 25$	$X * 10$ ms	$X * 100$ ms

For example, a setting value of 100 results in the scanner turning off approximately 1 second after an object is removed from the field of view or 10 seconds while an object is in the field of view moving.

The default value of the setting is 15 which results in a Minimum time of 250 ms and Maximum time of 1.5 seconds.

User Preferences

Adjust this setting based on your requirements. For example, when doing prioritization, this parameter should be set to a value where the maximum time is above the PDF prioritization timeout.



Hands-free Decode Session Timeout

Timeout Between Decodes, Same Symbol

Parameter # 137 (SSI # 89h)

Use this option in presentation mode to prevent the beeper from continuously beeping when a symbol is left in the imager's field of view. The barcode must be out of the field of view for the timeout period before the imager reads the same consecutive symbol. It is programmable in 0.1 second increments from 0.0 to 9.9 seconds. The default interval is 0.5 seconds.

To select the timeout between decodes for the same symbol, scan the barcode below, then scan two numeric barcodes from [Numeric Barcodes](#) that correspond to the desired interval, in 0.1 second increments.



Timeout Between Decodes, Same Symbol

Timeout Between Decodes, Different Symbols

Parameter # 144 (SSI # 90h)

Use this option in presentation mode to control the time the imager is inactive between decoding different symbols. It is programmable in 0.1 second increments from 0.1 to 9.9 seconds. The default is 0.1 seconds.

To select the timeout between decodes for different symbols, scan the barcode below, then scan two numeric barcodes from [Numeric Barcodes](#) that correspond to the desired interval, in 0.1 second increments.



NOTE: Timeout Between Decodes, Different Symbols cannot be greater than or equal to the Decode Session Timeout.



Timeout Between Decodes, Different Symbols

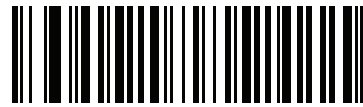
Mobile Phone/Display Mode

Parameter # 716 (SSI # F1h CCh)

This mode improves barcode reading performance off mobile phones and electronic displays. Select disable or enable Mobile Phone/Display Mode.



* Disable Mobile Phone/Display Mode
(0)



Enable Mobile Phone/Display Mode (3)

Scene Detect Mode (Wakeup)

Parameter # 2377 (SSI # F8 09 49)



NOTE: This parameter applies only to MS4727 and MS4777.

This parameter selects the method used to detect motion and activate a decode session.

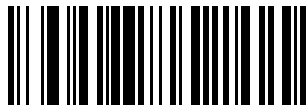
The available options are:

- Scene Detect - A decode session is triggered when a change in scene (for example, motion) is detected by the imaging sensor. Illumination is turned on and decoding is enabled. Scene Detect does not require illumination to detect a change in scene (for example, Motion). Susceptible to inadvertent wakeup from motion beyond decode zone (for example, people moving past scanner).



NOTE: Increase the [Hands-Free Decode Session Timeout on page 69](#) for a better performance.

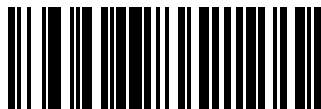
- Object Detect (Default) - A decode session is triggered when a barcode is detected by the imaging sensor. Illumination is increased and decoding is enabled. Object detect requires some illumination to detect the object (for example, Barcode). Less susceptible than Scene Detect to inadvertent wakeup from motion beyond decode zone (for example, people moving past scanner).
- Auto - It will automatically pick "Object Detect" if the scan engine supports it. Otherwise, it will pick "Scene Detect" motion detect mode.



Auto
(0)



***Object Detect**
(1)



Scene Detect
(2)

PDF Prioritization

Parameter # 719 (SSI # F1h CFh)

Enable this feature to delay decoding a 1D barcode (Code 128) by the value specified in [PDF Prioritization Timeout](#). During that time the imager attempts to decode a PDF417 symbol (e.g., on a US driver's license), and if successful, reports this only. If it does not decode (can not find) a PDF417 symbol, it reports the 1D symbol after the timeout. The 1D symbol must be in the imager's field of view for the imager to report it. This parameter does not affect decoding other symbologies.



NOTE: The 1D Code 128 barcode lengths include the following:

- 7 to 10 characters
- 14 to 22 characters
- 27 to 28 characters

In addition, a Code 39 barcode with the following lengths are considered to potentially be part of a US driver's license:

- 8 characters
- 12 characters



*** Disable PDF Prioritization
(0)**



**Enable PDF Prioritization
(1)**

PDF Prioritization Timeout

Parameter # 720 (SSI # F1h D0h)



NOTE: The [Hands-Free Decode Session Timeout on page 69](#) should be set to a longer duration than **PDF Prioritization Timeout** when configured.

When [PDF Prioritization on page 74](#) is enabled, this timeout specifies how long the imager attempts to decode a PDF417 symbol before reporting the 1D barcode in the field of view.

Scan the following barcode, then scan four digits from [Numeric Barcodes](#) that specify the timeout in milliseconds. For example, to enter 400 msec, scan the following barcode, then scan 0400. The range is 0 to 5000 msec, and the default is 200 msec.



PDF Prioritization Timeout

Low Light Motion Detection Assist

Parameter # 810 (SSI # F2h 2Ah)

In **Presentation Mode**, this feature allows motion detection in dim to dark illumination environments by using the aiming dot or dim illumination to assist in the detection of motion by providing a low light source.

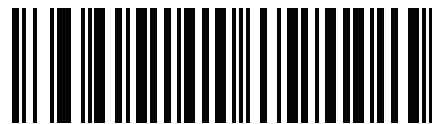


NOTE: If this parameter is **Dim Illumination for Low Light Motion Detection Assist** and [Decoding Illumination on page 79](#) is disabled, this parameter takes precedence.

The decoder does not support **Aiming Dot for Low Light Motion Detection Assist** for any scan engines with a laser aimer.



* Disable Low Light Motion Detection Assist
(00h)



Enable Aiming Dot for Low Light Motion
Detection Assist
(01h)



Enable Dim Illumination for Low Light Motion
Detection Assist
(02h)

Presentation Mode Field of View

Parameter # 609 (SSI # F1h 61h)

In presentation mode, by default the imager searches the larger area of the aiming pattern (**Full Field of View**).

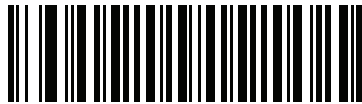
To search for a barcode in a smaller region around the aiming dot's center in order to speed search time, select **Small Field of View** or **Medium Field of View**.



**Small Field of View
(0)**



**Medium Field of View
(1)**



*** Full Field of View
(2)**

Scene Detect Sensitivity

Parameter # 1943 (SSI # F8h 97h)

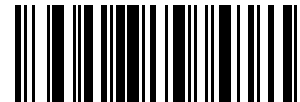


NOTE: This parameter is for the MS4717 only.

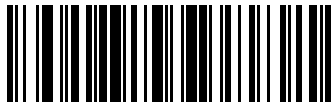
This parameter sets the illumination range sensitivity when motion is detected.



Low
(10)



***Medium**
(128)



High
(190)

Mirrored Image

Parameter # 624

SSI # F1h 70h

Enable this to scan images in reverse, or mirrored, as if seen through a mirror. This mode is useful in applications requiring scanning through a mirror and using symbologies that do not decode in reverse.

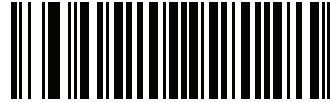
Enabling this mode when using snapshot, video, or video viewfinder mode transmits images as mirrored images.



NOTE: This parameter is enabled by default for the MS47 with Cone.



***Disable Mirrored Image
(00h)**



**Enable Mirrored Image
(01h)**

Decoding Illumination

Parameter # 298 (SSI # F0h 2Ah)

Selecting **Enable Decoding Illumination** causes the imager to flash illumination to aid decoding. Select **Disable Decoding Illumination** to prevent the imager from using decoding illumination.

Enabling illumination usually results in superior images. The effectiveness of the illumination decreases as the distance to the target increases.



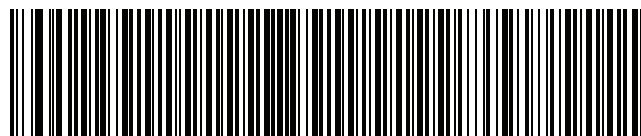
*** Enable Decoding Illumination
(1)**



**Disable Decoding Illumination
(0)**

Add an Enter Key

To add an Enter key (carriage return/line feed) after scanned data, scan the following barcode. To program other prefixes and/or suffixes, see [Prefix/Suffix Values on page 81](#).



Add Enter Key (Carriage Return/Line Feed)

Transmit Code ID Character

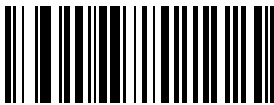
Parameter # 45 (SSI # 2Dh)

A Code ID character identifies the code type of a scanned barcode. This is useful when decoding more than one code type. In addition to any single character prefix already selected, the Code ID character is inserted between the prefix and the decoded symbol.

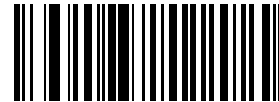
Select no Code ID character, a Symbol Code ID character, or an AIM Code ID character.



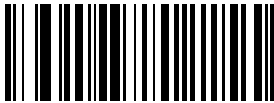
NOTE: If you enable Symbol Code ID Character or AIM Code ID Character, and enable [Transmit "No Read" Message on page 84](#), the imager appends the code ID for Code 39 to the NR message.



**Symbol Code ID Character
(2)**



**AIM Code ID Character
(1)**



*** None
(0)**

Prefix/Suffix Values

Key Category Parameter # P = 99, S1 = 98, S2 = 100 (SSI # P = 63h, S1 = 62h, S2 = 64h)

Decimal Value Parameter # P = 105, S1 = 104, S2 = 106 (SSI # P = 69h, S1 = 68h, S2 = 6Ah)

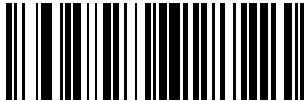
You can append a prefix and/or one or two suffixes to scan data for use in data editing. To set a value for a prefix or suffix, scan a four-digit number (i.e., four barcodes from [Numeric Barcodes](#)) that corresponds to that value. See [ASCII Character Sets](#) for the four-digit codes.

When using host commands to set the prefix or suffix, set the key category parameter to 1, then set the 3-digit decimal value. See [ASCII Character Sets](#) for the four-digit codes.

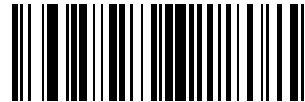
The default prefix and suffix value is 7013 <CR><LF> (the Enter key). To correct an error or change a selection, scan [Cancel on page 413](#).



NOTE: To use Prefix/Suffix values, first set the [Scan Data Transmission Format on page 82](#).



**Scan Prefix
(7)**



**Scan Suffix 1
(6)**



**Scan Suffix 2
(8)**



Data Format Cancel

Scan Data Transmission Format

Parameter # 235 (SSI # EBh)

To change the scan data format, scan one of the following eight barcodes corresponding to the desired format.



NOTE: If using this parameter do not use ADF rules to set the prefix/suffix.

To set values for the prefix and/or suffix, see [ASCII Character Sets](#)



* Data As Is
(0)



<DATA> <SUFFIX 1>
(1)



<DATA> <SUFFIX 2>
(2)



<DATA> <SUFFIX 1> <SUFFIX 2>
(3)



<PREFIX> <DATA >
(4)

Scan Data Transmission Format (continued)



<PREFIX> <DATA> <SUFFIX 1>
(5)



<PREFIX> <DATA> <SUFFIX 2>
(6)



<PREFIX> <DATA> <SUFFIX 1> <SUFFIX 2>
(7)

FN1 Substitution Values

Key Category Parameter # 103 (SSI # 67h)

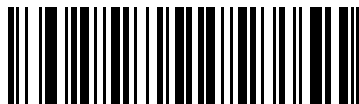
Decimal Value Parameter # 109 (SSI # 6Dh)

The USB HID keyboard hosts support a FN1 Substitution feature. Enabling this substitutes any FN1 character (0x1b) in an EAN128 barcode with a value. This value defaults to 7013 (Enter Key).

When using host commands to set the FN1 substitution value, set the key category parameter to 1, then set the 3-digit keystroke value. See the ASCII Character Set table for the current host interface for the desired value.

To select a FN1 substitution value via barcode menus:

1. Scan the barcode below.



Set FN1 Substitution Value

2. Locate the keystroke desired for FN1 Substitution in the ASCII Character Set table for the current host interface. Enter the 4-digit ASCII Value by scanning each digit in [Numeric Barcodes](#).

To correct an error or change the selection, scan **Cancel**.

To enable FN1 substitution for USB HID keyboard, scan the **Enable FN1 Substitution** barcode on page [83](#).

Transmit “No Read” Message

Parameter # 94 (SSI # 5Eh)

Scan a barcode below to select whether or not to transmit a No Read message. Enable this to transmit the characters NR when a successful decode does not occur before trigger release or the **Decode Session Timeout** expires. See [Decode Session Timeout on page 69](#). Disable this to send nothing to the host if a symbol does not decode.



NOTE: If you enable **Transmit No Read**, and also enable Symbol Code ID Character or AIM Code ID Character for [Transmit Code ID Character on page 80](#), the digital scanner appends the code ID for Code 39 to the NR message.



**Enable No Read
(1)**



*** Disable No Read
(0)**

Unsolicited Heartbeat Interval

Parameter # 1118 (SSI # F8h 04h 5Eh)

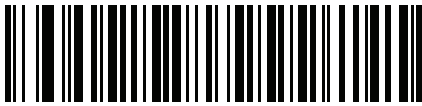
The imager supports sending *Unsolicited Heartbeat Messages* to assist in diagnostics. To enable this feature and set the desired unsolicited heartbeat interval, scan one of the time interval barcodes below, or scan **Set Another Interval** followed by four numeric barcodes from [Numeric Barcodes](#) (scan sequential numbers that correspond to the desired number of seconds). The range is 0 - 9999.

Scan **Disable Unsolicited Heartbeat Interval** to turn off the feature.

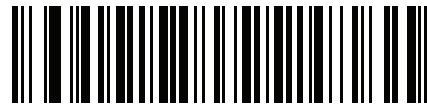
The heartbeat event is sent as decode data (with no decode beep) in the form of:

MOTEVTHB:nnn

where *nnn* is a three-digit sequence number starting at 001 and wrapping after 100.



10 Seconds
(10)



1 Minute
(60)



Set Another Interval



*** Disable Unsolicited Heartbeat Interval**
(0)

Report Version

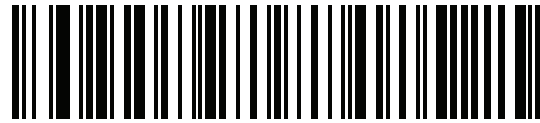
Scan the barcode below to report the version of software currently installed on the imager.



Report Software Version

Report Decoder Manufacturing Information

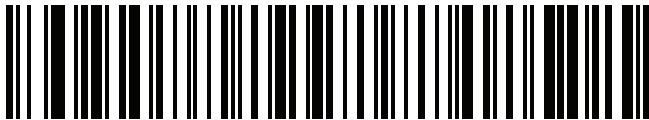
Scan the barcode below to report the part number, serial number, and manufacture date of the decoder.



Report Decoder Manufacturing Information

Report Engine Manufacturing Information

Scan the barcode below to report the part number, serial number, and manufacture date of the scan engine.



Report Engine Manufacturing Information

Imager Preferences

Introduction

Users can program the device to perform various functions, or activate different features. This chapter describes imaging preference features and provides programming barcodes for selecting these features.



NOTE: Only the Symbol Native API (SNAPI) with Imaging interface supports image capture. See [USB Device Type on page 116](#) to enable this host.

The imager ships with the settings in [Imaging Preferences Parameter Defaults on page 88](#) (also see [Standard Default Parameters](#) for all host device and defaults). If the default values suit requirements, programming is not necessary.

To set feature values, scan a single barcode or a short barcode sequence. The settings are stored in non-volatile memory and are preserved even when you power down the digital scanner.



NOTE: Most computer monitors allow scanning the barcodes directly on the screen. When scanning from the screen, be sure to set the document magnification to a level where you can see the barcode clearly, and bars and/or spaces are not merging.

To return all features to default values, scan the [Default Parameters on page 59](#). Throughout the programming barcode menus, asterisks (*) indicate default values.



Scanning Sequence Examples

In most cases scanning one barcode sets the parameter value. For example, to disable image capture illumination, scan the **Disable Image Capture Illumination** barcode under [In this mode the imager behaves as a video camera as long as the trigger is active. Upon trigger release, the imager returns to Decode Mode. Scan the Video Mode barcode to temporarily enter Video Capture Mode. on page 92](#). The imager issues a fast warble beep and the LED turns green, signifying a successful parameter entry.

Other parameters require scanning several barcodes. See these parameter descriptions for this procedure.

Errors While Scanning

Unless otherwise specified, to correct an error during a scanning sequence, just re-scan the correct parameter.

Imaging Preferences Parameter Defaults

[Table 12](#) lists the defaults for imaging preferences parameters. To change the default values, scan the appropriate barcodes in this guide. These new values replace the standard default values in memory.



NOTE: See [Standard Default Parameters](#) for all user preferences, hosts, symbologies, and default parameters.

Table 12 Imaging Preferences Parameter Defaults

Parameter	Parameter Number	SSI Number	Default	Page Number
Imaging Preferences				
Operational Modes	N/A	N/A	N/A	90
Aim Brightness	668	F1h 9Ch	High	91
Illumination Brightness	669	F1h 9Dh	10	91
Image Capture Illumination	361	F0h 69h	Enable	92
Image Capture Autoexposure	360	F0h 68h	Enable	92
Fixed Exposure	567	F4h F1h 37h	100	94
Gain / Exposure Priority for Snapshot Mode	562	F1h 32h	Autodetect	95
Snapshot Mode Timeout	323	F0h 43h	0 (30 Seconds)	96
Snapshot Aiming Pattern	300	F0h 2Ch	Enable	97
Silence Operational Mode Changes	1293	F8h 05h 0Dh	Do Not Silence (Disable)	97
Image Cropping	301	F0h 2Dh	Disable	98

Imager Preferences

Table 12 Imaging Preferences Parameter Defaults (Continued)

Parameter	Parameter Number	SSI Number	Default	Page Number
Crop to Pixel Addresses	315 316 317 318	F4h F0h 3Bh F4h F0h 3Ch F4h F0h 3Dh F4h F0h 3Eh	0 top 0 left 959 bottom 1279 right	99
Image Size (Number of Pixels)	302	F0h 2Eh	Full	100
Image Brightness (Target White)	390	F0h 86h	180	101
JPEG Image Options	299	F0h 2Bh	Quality	101
JPEG Target File Size	561	F1h 31h	160 kB	102
JPEG Quality	305	F0h 31h	65	102
Image Enhancement	564	F1h 34h	1 (Low)	103
Image File Format Selector	304	F0h 30h	JPEG	104
Image Rotation	665	F1h 99h	0°	105
Bits per Pixel (BPP)	303	F0h 2Fh	8 BPP	106
Signature Capture	93	5Dh	Disable	107
Signature Capture Image File Format Selection	313	F0h 39h	JPEG	108
Signature Capture Bits Per Pixel	314	F0h 3Ah	8 BPP	109
Signature Capture Width	366	F4h F0h 6Eh	400	110
Signature Capture Height	367	F4h F0h 6Fh	100	110
Signature Capture JPEG Quality	421	F0h A5h	65	110
Video View Finder	324	F0h 44h	Disable	111
Video View Finder Image Size	329	F0h 49h	1700 bytes	111

Imager Preferences

The parameters in this chapter control image capture characteristics. Image capture occurs in all modes of operation, including decode, video, and snapshot.

Operational Modes

The imager has three modes of operation:

- Decode Mode
- Snapshot Mode
 - Snapshot with Viewfinder Mode
- Video Mode.

Decode Mode

By default, upon a trigger event, the imager attempts to locate and decode barcodes within its field of view. The imager remains in this mode as long as the trigger is active, until it decodes a barcode, or it reaches the [Decode Session Timeout on page 69](#).

Snapshot Mode

Use Snapshot Mode to capture a high-quality image and transmit it to the host. To temporarily enter this mode scan the **Snapshot Mode** barcode. While in this mode the imager blinks the green LED at 1-second intervals to indicate it is not in standard operating (decode) mode.

In Snapshot Mode, the imager turns on its aiming pattern to highlight the area to capture in the image. The next trigger event instructs the imager to capture a high quality image and transmit it to the host. A short time may pass (less than 2 seconds) between trigger activation and image capture as the imager adjusts to the lighting conditions. Hold the imager steady until image capture, denoted by a single beep.

If a trigger event does not occur within the Snapshot Mode Timeout period, the imager returns to Decode Mode. Use [Snapshot Mode Timeout on page 96](#) to adjust this timeout period. The default timeout period is 30 seconds.

To disable the laser aiming pattern during Snapshot Mode, see [Snapshot Aiming Pattern on page 97](#).

Use [Video View Finder on page 112](#) to enable **Snapshot with Viewfinder Mode**. In this mode the imager behaves as a video camera until the trigger activates, at which time a Snapshot occurs as described above.

Aim Brightness

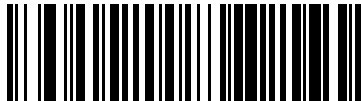
Parameter # 668

SSI # F1h 9Ch

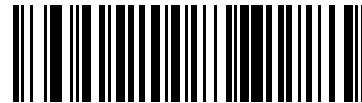
Scan one of the following bar codes to set the aim pattern brightness or power. Options are low, medium, and high.



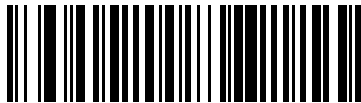
NOTE: This parameter is available for the MS4717 only.



Aim Brightness - Low (0)



Aim Brightness - Medium (1)



*Aim Brightness - High (2)

Illumination Brightness

Parameter # 669

SSI # F1h 9Dh

This feature sets the brightness of the illumination by altering LED power. The default is 10, which is maximum LED brightness. For values from 1 to 10, LED brightness varies from lowest to highest level of brightness.

To program Illumination Brightness, scan this barcode followed by two numeric barcodes in [Numeric Barcodes](#) that correspond to the value of desired illumination brightness. For example, to set Illumination Brightness to 6, scan the barcode below followed by the 0 and 6 barcodes.



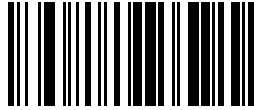
NOTE: This parameter is available for the MS4727/MS4777 only.



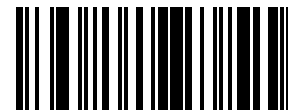
Illumination Brightness

Video Mode

In this mode the imager behaves as a video camera as long as the trigger is active. Upon trigger release, the imager returns to Decode Mode. Scan the **Video Mode** barcode to temporarily enter Video Capture Mode.



Snapshot Mode



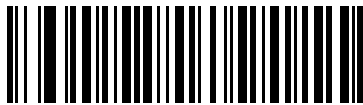
Video Mode

Image Capture Illumination

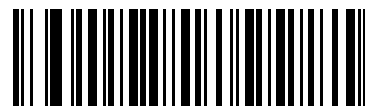
Parameter # 361 (SSI # F0h 69h)

Selecting **Enable Image Capture Illumination** causes illumination to turn on during every image capture. Disable illumination to prevent the imager from using illumination.

Enabling illumination usually results in superior images. The effectiveness of illumination decreases as the distance to the target increases.



*** Enable Image Capture Illumination
(1)**



**Disable Image Capture Illumination
(0)**

Image Capture Autoexposure

Parameter # 360 (SSI # F0h 68h)

Select **Enable Image Capture Autoexposure** to allow the imager to control gain settings and exposure (integration) time to best capture an image for the selected operation mode.

Select **Disable Image Capture Autoexposure** to manually adjust the gain and exposure time (see the following pages). This option is only recommended for advanced users with difficult image capture situations.



*** Enable Image Capture Autoexposure
(1)**



**Disable Image Capture Autoexposure
(0)**

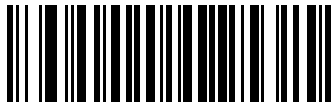
Fixed Exposure

Parameter # 567 (SSI # F4h F1h 37h)

This parameter configures the exposure used in manual mode for Snapshot.

Each integer value represents 100 ms worth of exposure. The default value is 100 which results in an exposure setting of 10 msec.

To set the Fixed Exposure parameter, scan **Fixed Exposure** followed by four numeric barcodes representing the value. Leading zeros are required. For example, to set a Fixed Exposure value of 99, scan 0, 0, 9, 9. See [Numeric Barcodes](#) for numeric barcodes.



Fixed Exposure
(4 digits)

Gain/Exposure Priority for Snapshot Mode

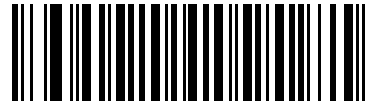
Parameter # 562 (SSI # F1h 32h)

This parameter alters the imager's gain exposure priority when it acquires an image in Snapshot Mode in auto exposure mode.

- Scan **Low Exposure Priority** to set a mode in which the imager favors higher gain over exposure to capture an image. This results in an image that is less susceptible to motion blur at the expense of noise artifacts. However, for most applications, the amount of noise is acceptable.
- Scan **Low Gain Priority** to set a mode in which the imager favors longer exposure time rather than higher gain to capture an image. This ensures that the image is less noisy and produces fewer artifacts during post processing activities like image enhancement (sharpening). The mode is recommended for fixed mount / fixed object image capture since the image acquired is susceptible to motion blur.
- Scan **Autodetect** (default) to set a mode in which the imager automatically selects Gain Priority or Low Exposure Priority mode for Snapshot Mode. If the imager is in a magnetic reed switch enabled stand (or it is configured in Blink Mode), it uses Low Gain Priority mode. Otherwise, it uses the Low Exposure Priority mode.



Low Gain Priority
(0)



Low Exposure Priority
(1)



*** Autodetect**
(2)

Snapshot Mode Timeout

Parameter # 323 (SSI # F0h 43h)

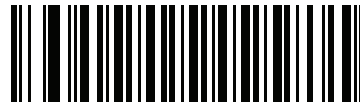
This parameter sets the amount of time the imager remains in Snapshot Mode. The imager exits Snapshot Mode when you pull the trigger, or when the Snapshot Mode Timeout elapses. To set this timeout value, scan the **Set Snapshot Mode Timeout** barcode below followed by a barcode from [Numeric Barcodes](#). The default value is 0 which represents 30 seconds; values increment by 30. For example, 1 = 60 seconds, 2 = 90 seconds, etc.

To quickly re-set the default timeout to 30 seconds, scan the **30 Seconds** barcode below.

If you select **No Timeout**, the imager remains in Snapshot Mode until you pull the trigger.



Set Snapshot Mode Timeout



*** 30 Seconds
(0)**



**No Timeout
(255)**

Snapshot Aiming Pattern

Parameter # 300 (SSI # F0h 2Ch)

Select **Enable Snapshot Aiming Pattern** to project the aiming pattern when in Snapshot Mode, or **Disable Snapshot Aiming Pattern** to turn the aiming pattern off.



* Enable Snapshot Aiming Pattern
(1)



Disable Snapshot Aiming Pattern
(0)

Silence Operational Mode Changes

Parameter # 1293 (SSI # F8h 05h 0Dh)

Enable this feature to silence the beeper when switching between operational modes (e.g., from Decode Mode to Snapshot Mode).



Silence Operational Mode Changes (Enable)
(1)

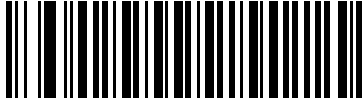


* Do Not Silence Operational Mode Changes (Disable)
(0)

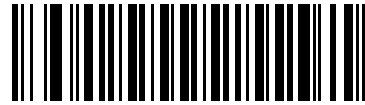
Image Cropping

Parameter # 301 (SSI # F0h 2Dh)

This parameter crops a captured image. Select **Disable Image Cropping** to present the full 1280 x 800 pixels. Select **Enable Image Cropping** to crop the image to the pixel addresses set in [Crop to Pixel Addresses on page 99](#).



Enable Image Cropping
(1)



*** Disable Image Cropping**
(Use Full 1280 x 800 Pixels)
(0)

Crop to Pixel Addresses

Parameter # 315 (SSI # F4h F0h 3Bh) (Top)

Parameter # 316 (SSI # F4h F0h 3Ch) (Left)

Parameter # 317 (SSI # F4h F0h 3Dh) (Bottom)

Parameter # 318 (SSI # F4h F0h 3Eh) (Right)

If you selected **Enable Image Cropping**, set the pixel addresses from (0,0) to (1279 x 959) to crop to.

Columns are numbered from 0 to 1279, rows from 0 to 799. Specify four values for Top, Left, Bottom, and Right, where Top and Bottom correspond to row pixel addresses, and Left and Right correspond to column pixel addresses. For example, for a 4 row x 8 column image in the extreme bottom-right section of the image set the following values:

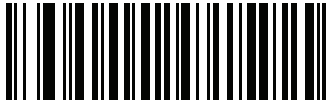
Top = 959, Bottom = 959, Left = 1272, Right = 1279

To set the crop to pixel address, scan each pixel address barcode below followed by four numeric barcodes representing the value. Leading zeros are required. For example, to crop the top pixel address to 3, scan 0, 0, 0, 3. See [Numeric Barcodes](#) for numeric barcodes. The defaults are:

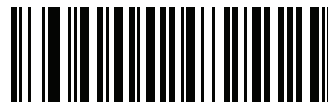
Top = 0, Bottom = 959, Left = 0, Right = 1279



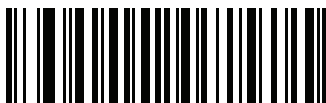
NOTE: The imager has a cropping resolution of 4 pixels. Setting the cropping area to less than 4 pixels (after resolution adjustment, see [Image Size \(Number of Pixels\) on page 100](#)) transfers the entire image.



Top Pixel Address
(0 - 959 Decimal)



Left Pixel Address
(0 - 1279 Decimal)



Bottom Pixel Address
(0 - 959 Decimal)



Right Pixel Address
(0 - 1279 Decimal)

Image Size (Number of Pixels)

Parameter # 302 (SSI # F0h 2Eh)

This option alters image resolution before compression. Multiple pixels are combined to one pixel, resulting in a smaller image containing the original content with reduced resolution.

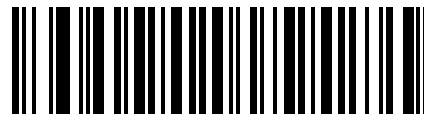
Select one of the following values:

Table 13 Image Size

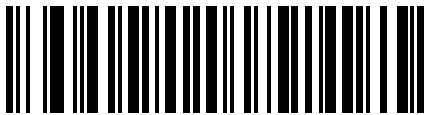
Resolution Value	Uncropped Image Size
Full	1280 x 800
1/2	640 x 400
1/4	320 x 200



* Full Resolution
(0)



1/2 Resolution
(1)



1/4 Resolution
(3)

Image Brightness (Target White)

Parameter # 390 (SSI # F0h 86h)

This parameter sets the Target White value used in Snapshot mode when using auto exposure. White and black are defined as 240 decimal and 1, respectively. Setting the value to the factory default of 180 sets the white level of the image to ~180.

To set the Image Brightness parameter, scan **Image Brightness** below followed by three numeric barcodes representing the value. Leading zeros are required. For example, to set an Image Brightness value of 99, scan 0, 9, 9. See [Numeric Barcodes](#) for numeric barcodes.



JPEG Image Options

Parameter # 299 (SSI # F0h 2Bh)

Select an option to optimize JPEG images for either size or for quality. Scan the **JPEG Quality Selector** barcode to use a quality value; the imager then selects the corresponding image size. Scan the **JPEG Size Selector** barcode to use a size value; the imager then selects the best image quality.



JPEG Target File Size

Parameter # 561 (SSI # F1h 31h)

This parameter defines the target JPEG file size in terms 1 Kilobytes (1024 bytes). The default value is 160 kB which represents 160 Kilobytes.



CAUTION JPEG compress may take 10 to 15 seconds based on the amount of information in the target image. Scanning **JPEG Quality Selector** (default setting) produces a compressed image that is consistent in quality and compression time.

To set the JPEG Target File Size parameter, scan **JPEG Target File Size** below followed by three numeric barcodes representing the value. Leading zeros are required. For example, to set an image file size value of 99, scan 0, 9, 9 in [Numeric Barcodes](#).

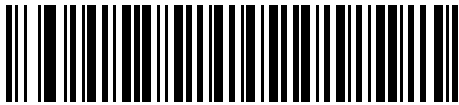


JPEG Target File Size
(3 digits)

JPEG Quality

Parameter # 305 (SSI # F0h 31h)

If you selected **JPEG Quality Selector**, scan the **JPEG Quality Value** barcode followed by 3 barcodes from [Numeric Barcodes](#) corresponding to a value from 5 to 100, where 100 represents the highest quality image.



JPEG Quality Value
(Default: 065)
(5 - 100 Decimal)

Image Enhancement

Parameter # 564 (SSI # F1h 34h)

This parameter configures the imager's Image Enhance feature. This feature uses a combination of edge sharpening and contrast enhancement to produce an image that is visually pleasing.

The levels of image enhancement are:

- Off (0)
- Low (1) - Default
- Med (2)
- High (3)



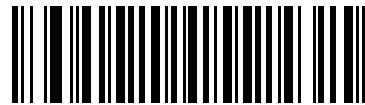
Off
(0)



* Low
(1)



Medium
(2)



High
(3)

Image File Format Selector

Parameter # 304 (SSI # F0h 30h)

Select an image format appropriate for the system (BMP, TIFF, or JPEG). The imager stores captured images in the selected format.



BMP File Format
(3)



*** JPEG File Format**
(1)



TIFF File Format
(4)

Image Rotation

Parameter # 665 (SSI # F1h 99h)

This parameter controls the rotation of the image by 0, 90, 180, or 270°.



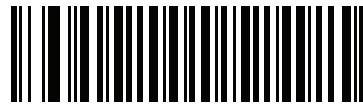
* Rotate 0°
(0)



Rotate 90°
(1)



Rotate 180°
(2)



Rotate 270°
(3)

Bits Per Pixel (BPP)

Parameter # 303 (SSI # F0h 2Fh)

Select the number of significant bits per pixel (BPP) to use when capturing an image. Select **1 BPP** for a black and white image, **4 BPP** to assign 1 of 16 levels of grey to each pixel, or **8 BPP** to assign 1 of 256 levels of grey to each pixel.



NOTE The digital scanner ignores these settings for JPEG file formats, which only support **8 BPP**.

The digital scanner ignores 1 BPP for TIFF file formats, which only support **4 BPP** and **8 BPP**. 1 BPP is coerced to 4 BPP for TIFF file formats.



1 BPP
(0)



4 BPP
(1)



*** 8 BPP**
(2)

Signature Capture

Parameter # 93 (SSI # 5Dh)

A signature capture barcode is a special-purpose symbology which delineates a signature capture area in a document with a machine-readable format. The recognition pattern is variable so it can optionally provide an index to various signatures. The region inside the barcode pattern is considered the signature capture area. See [Signature Capture Code](#) for more information.

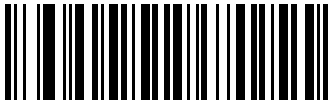
Output File Format

Decoding a signature capture barcode de-skews the signature image and converts the image to a BMP, JPEG, or TIFF file format. The output data includes the file descriptor followed by the formatted signature image.

Table 14 Output File Format

File Descriptor			Signature Image
Output Format (1 byte)	Signature Type (1 byte)	Signature Image Size (4 bytes) (BIG Endian)	
JPEG - 1 BMP - 3 TIFF - 4	1-8	0x00000400	0x00010203....

To enable or disable Signature Capture, scan the appropriate barcode below.



**Enable Signature Capture
(1)**



*** Disable Signature Capture
(0)**

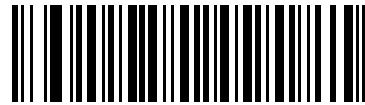
Signature Capture Image File Format Selection

Parameter # 313 (SSI # F0h 39h)

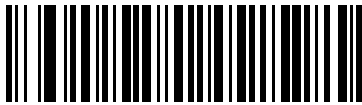
Select a signature file format appropriate for the system (BMP, TIFF, or JPEG). The digital scanner stores captured signatures in the selected format.



BMP Signature Format
(3)



*** JPEG Signature Format**
(1)



TIFF Signature Format
(4)

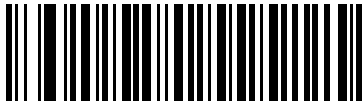
Signature Capture Bits Per Pixel

Parameter # 314 (SSI # F0h 3Ah)

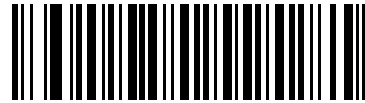
Select the number of significant bits per pixel (BPP) to use when capturing a signature. Select **1 BPP** for a black and white image, **4 BPP** to assign 1 of 16 levels of grey to each pixel, or **8 BPP** to assign 1 of 256 levels of grey to each pixel.



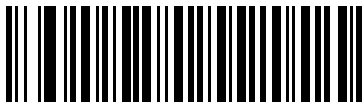
NOTE The digital scanner ignores these settings for JPEG file formats, which only support **8 BPP**.



1 BPP
(0)



4 BPP
(1)



*** 8 BPP**
(2)

Signature Capture Width

Parameter # 366 (SSI # F4h F0h 6Eh)

The aspect ratio of the Signature Capture Width and Signature Capture Height parameters must match that of the signature capture area. For example, a 4 x 1 inch signature capture area would require a 4 to 1 aspect ratio of width to height.

To set the width of the signature capture box, scan the **Signature Capture Width** barcode, followed by 3 barcodes from [Numeric Barcodes](#) corresponding to a value in the range of 016 to 640 decimal.



Signature Capture Width
(Default: 400)
(016 - 640 Decimal)

Signature Capture Height

Parameter # 367 (SSI # F4h F0h 6Fh)

To set the height of the signature capture box, scan the **Signature Capture Height** barcode, followed by 3 barcodes from [Numeric Barcodes](#) corresponding to a value in the range of 016 to 480 decimal.



Signature Capture Height (Default: 100)
(016 - 480 Decimal)

Signature Capture JPEG Quality

Parameter # 421 (SSI # F0h A5h)

Scan the **JPEG Quality Value** barcode followed by 3 barcodes from [Numeric Barcodes](#) corresponding to a value from 005 to 100, where 100 represents the highest quality image.



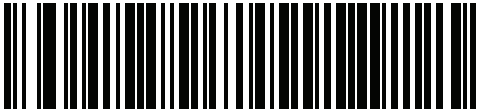
JPEG Quality Value (Default: 065)
(5 - 100 Decimal)

Video View Finder Image Size

Parameter # 329 (SSI # F0h 49h)

Select the number of 100-byte blocks. Values range from 800 to 12,000 bytes. Selecting a smaller value transmits more frames per second; selecting a larger value increases video quality.

To set the Video View Finder Image Size, scan the barcode below followed by three barcodes from [Numeric Barcodes](#) corresponding to the 100-byte value from 800 to 12,000 bytes. For example, to select 1500 bytes, enter 0, 1, 5. To select 900 bytes, enter 0, 0, 9. The default is 1700 bytes.

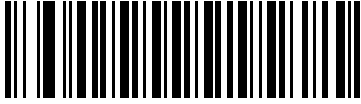


Video View Finder Image Size

Video View Finder

Parameter # 324 (SSI # F0h 44h)

Select **Enable Video View Finder** to project the video view finder while in Video Mode, or **Disable Video View Finder** to turn the video view finder off.



* **Disable Video View Finder**
(0)



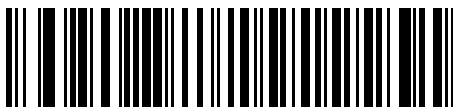
Enable Video View Finder
(1)

USB Interface

Introduction

This chapter provides instructions for programming the imager to interface with a USB host. The imager connects directly to a USB host, or a powered USB hub. The USB host can power the imager.

Throughout the programming barcode menus, default values are indicated with asterisks (*).



*Indicates Default — * **North American Standard USB Keyboard** — Feature/Option

Connecting a USB Interface

The imager connects with USB capable hosts including:

- TGIS (IBM) terminals
- Apple™ desktops and notebooks
- Other network computers that support more than one keyboard.

The following operating systems support the imager through USB:

- Windows XP, 7, 8, 10, and 11
- MacOS 8.5 - MacOS 10.7

To connect the imager to a USB host:

1. Attach the USB-Micro B connector to the scanner and the remaining USB-A end to the host.
2. Ensure all connections are secure.
3. Select the USB device type by scanning the appropriate barcode from [USB Device Type on page 116](#).
4. On first installation when using Windows, the software displays a prompt to select or install the *Human Interface Device* driver. To install the Human Interface Device driver provided by Windows, click **Next** through all the choices and click **Finished** on the last choice. The imager powers up during this installation.
5. To modify any other parameter options, scan the appropriate barcodes in this chapter.

If problems occur, see [Troubleshooting on page 54](#).

USB Parameter Defaults

Table 15 lists the defaults for USB host parameters. If any option needs to be changed, scan the appropriate barcode(s) provided in the Parameter Descriptions section beginning on [page 116](#).



NOTE: See [Standard Default Parameters](#) for all user preferences, hosts, symbologies, and default parameters.



NOTE: See [Country Codes](#) for USB Country Keyboard Types (Country Codes).

Table 15 USB Host Default Table

Parameter	Default	Page Number
USB Host Parameters		
USB Device Type	HID Keyboard Emulation	116
Symbol Native API (SNAPI) Status Handshaking	Enable	118
USB Keystroke Delay	No Delay	118
USB CAPS Lock Override	Disable	119
USB Ignore Unknown Characters	Send	120
USB Convert Unknown to Code 39	Disable	120
Emulate Keypad	Enable	121
Emulate Keypad with Leading Zero	Enable	121
Quick Keypad Emulation	Enable	122
USB FN1 Substitution	Disable	122
Function Key Mapping	Disable	123
Simulated Caps Lock	Disable	123
Convert Case	No Case Conversion	124
USB CDC Host Variant	Standard USB CDC	125
USB Static CDC	Enable	125
Product ID (PID) Type	Host Type Unique	126
Product ID (PID) Value	N/A	126
Datalogic Host Format	Enable	127
Datalogic Supported Commands	Disable	127
Ignore Beep Directive	Enable	128
Ignore Barcode Configuration	Enable	128
USB Polling Interval	3 msec	129

Table 15 USB Host Default Table (Continued)

Parameter	Default	Page Number
USB Fast HID	Enable	131
IBM Specification Version	Version 2.2	131

USB Host Parameter

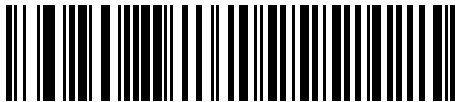
USB Device Type

Select the desired USB device type.



NOTES

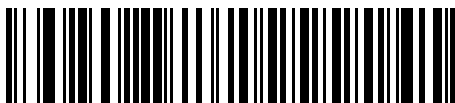
1. When changing USB device types, the scanner automatically restarts. The scanner issues a power-up beep sequence.
2. Before selecting USB CDC Host, install the Zebra USB CDC Driver (located at: zebra.com/us/en/support-downloads/software/drivers/usb-cdc-driver.html) on the host to ensure the scanner does not stall during power up (due to a failure to enumerate USB). To recover a stalled scanner, first disconnect scanner from host. Install the CDC driver then reconnect the scanner.
3. When USB HID Keyboard Emulation or USB CDC Host is selected, and the **Trigger Mode** is set to Host, the scanner will be in locked mode and no scanning is possible. The scanner will exit this mode if the host sends the following commands to the scanner. The scanner's trigger mode can then be changed by the host.
 - For HID Keyboard Emulation send switch to SNAPI host command. Use the Zebra SDK's C Sharp Sample Application or 123Scan to do this.
 - For USB CDC Host, send the following two-byte sequences to the scanner. ESC is ASCII 27.
 - Temporarily switch to SSI Over USB CDC: ESC s (lower case s or ASCII 115)
 - Permanently switch to SSI Over USB CDC: ESC S (upper case S or ASCII 83)
 - Temporarily switch to SNAPI: ESC a (lower case a or ASCII 97)
 - Permanently switch to SNAPI: ESC A (upper case A or ASCII 65)
4. Select IBM Hand-held USB to disable data transmission when an IBM register issues a Scan Disable command. Aim, illumination, and decoding is still permitted. Select OPOS (IBM Hand-held with Full Disable) to completely shut off the scanner when an IBM register issues a Scan Disable command, including aim, illumination, decoding, and data transmission.



*** HID Keyboard Emulation
(Note 3)**



IBM Table-top USB



IBM Hand-held USB



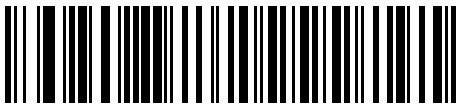
OPOS (IBM Hand-held with Full Disable)



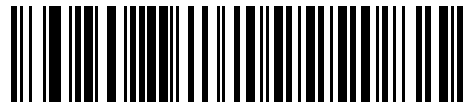
SSI over USB CDC



USB CDC Host
(Note 2 and 3)



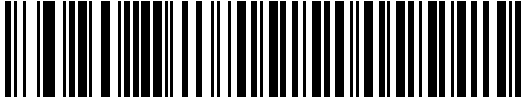
Symbol Native API (SNAPI) without Imaging Interface



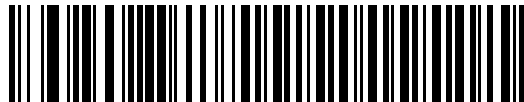
Symbol Native API (SNAPI) with Imaging Interface

Symbol Native API (SNAPI) Status Handshaking

After selecting a SNAPI interface as the USB device type, select whether to enable or disable status handshaking.



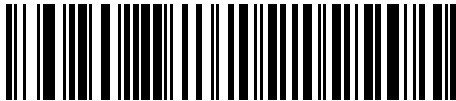
*** Enable SNAPI Status Handshaking**



Disable SNAPI Status Handshaking

USB Keystroke Delay

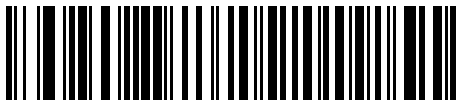
This parameter sets the delay, in milliseconds, between emulated keystrokes. Scan a barcode below to increase the delay when hosts require a slower transmission of data.



*** No Delay**



Medium Delay (20 msec)



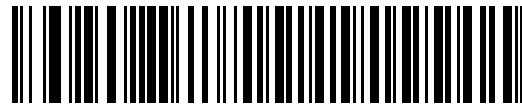
Long Delay (40 msec)

USB CAPS Lock Override

This option applies only to the HID Keyboard Emulation device. When enabled, the case of the data is preserved regardless of the state of the caps lock key. This setting is always enabled for the “Japanese, Windows (ASCII)” keyboard type and can not be disabled.



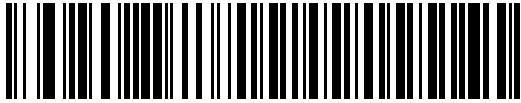
**Override Caps Lock Key
(Enable)**



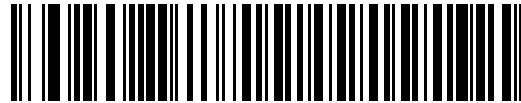
*** Do Not Override Caps Lock Key
(Disable)**

USB Ignore Unknown Characters

This option applies only to the HID Keyboard Emulation device and IBM device. Unknown characters are characters the host does not recognize. When **Send Barcodes With Unknown Characters** is selected, all barcode data is sent except for unknown characters, and no error beeps sound. When **Do Not Send Barcodes With Unknown Characters** is selected, barcode data is sent up to the first unknown character, then the imager issues an error beep.



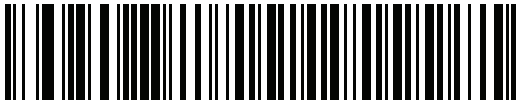
* **Send Barcodes with Unknown Characters**



Do Not Send Barcodes with Unknown Characters

USB Convert Unknown to Code 39

This option applies only to IBM Table-top, and OPOS devices. Scan a barcode below to enable or disable converting unknown barcode type data to Code 39.



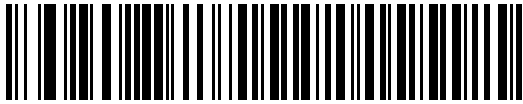
* **Disable Convert Unknown to Code 39**



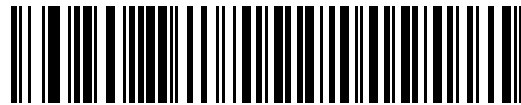
Enable Convert Unknown to Code 39

Emulate Keypad

When enabled, all characters are sent as ASCII sequences over the numeric keypad. For example ASCII A would be sent as “ALT make” 0 6 5 “ALT Break.”



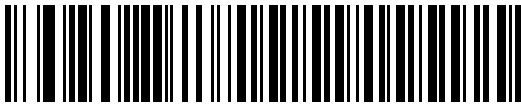
Disable Keypad Emulation



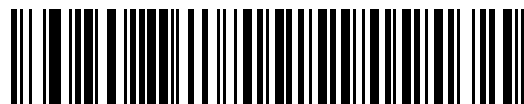
*** Enable Keypad Emulation**

Emulate Keypad with Leading Zero

Enable this to send character sequences sent over the numeric keypad as ISO characters which have a leading zero. For example ASCII A transmits as “ALT MAKE” 0 0 6 5 “ALT BREAK”.



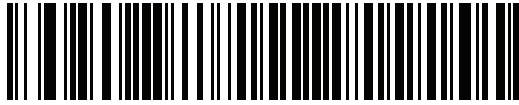
Disable Keypad Emulation with Leading Zero



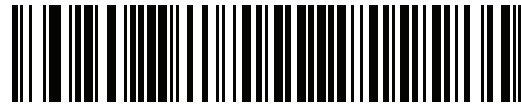
*** Enable Keypad Emulation with Leading Zero**

Quick Keypad Emulation

This option applies only to the HID Keyboard Emulation Device and if Emulate Keypad is enabled. This parameter enables a quicker method of keypad emulation where ASCII sequences are only sent for ASCII characters not found on the keyboard. The default value is **Enable**.



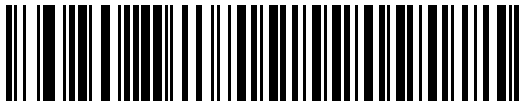
* **Enable**



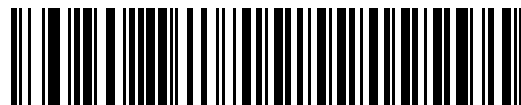
Disable

USB Keyboard FN 1 Substitution

This option applies only to the USB HID Keyboard Emulation device. When enabled, this allows replacement of any FN 1 characters in an EAN 128 barcode with a Key Category and value chosen by the user (see [FN1 Substitution Values on page 83](#) to set the Key Category and Key Value).



Enable FN1 Substitution



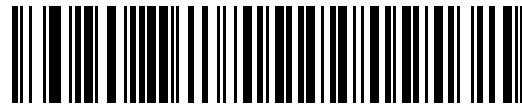
* **Disable FN1 Substitution**

Function Key Mapping

ASCII values under 32 are normally sent as a control-key sequences. When this parameter is enabled, the keys in bold are sent in place of the standard key mapping. Table entries that do not have a bold entry remain the same whether or not this parameter is enabled.



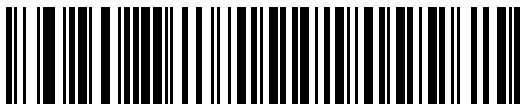
* **Disable Function Key Mapping**



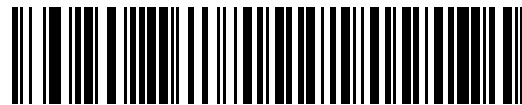
Enable Function Key Mapping

Simulated Caps Lock

When enabled, the imager inverts upper and lower case characters on the imager barcode as if the Caps Lock state is enabled on the keyboard. This inversion is done regardless of the current state of the keyboard's Caps Lock state.



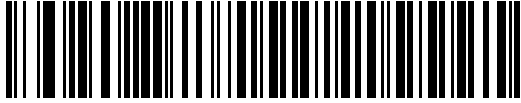
* **Disable Simulated Caps Lock**



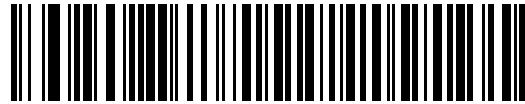
Enable Simulated Caps Lock

Convert Case

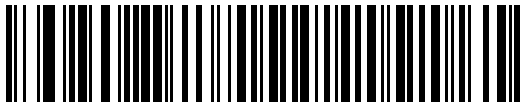
When enabled, the imager converts all barcode data to the selected case.



*** No Case Conversion**



Convert All to Upper Case

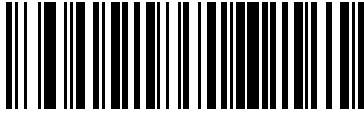


Convert All to Lower Case

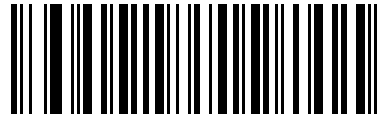
USB CDC Host Variant

Parameter # 1713

When USB Device Type is set to USB CDC Host, the CDC Host Variant selects which type of CDC variant is used. The default USB CDC host variant is Standard CDC Host Mode.



*** Standard USB CDC
(0)**



**Datalogic USB CDC Host Variant
(10)**

USB Static CDC

Parameter # 670

When disabled, each device connected consumes another COM port (first device = COM1, second device = COM2, third device = COM3, etc.)

When enabled, each device connects to the same COM port.



*** Enable USB Static CDC
(1)**



**Disable USB Static CDC
(0)**

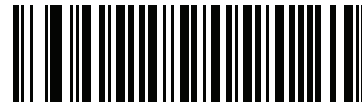
Product ID (PID) Type

Parameter # 1281 (SSI # F8h 05h 01h)

Scan one of the following barcodes to define the PID value reported in USB enumeration.



***Host Type Unique
(0)**



**Product Unique
(1)**



**IBM Unique
(2)**

Product ID (PID) Value

Parameter # 1725 (SSI # F8h 06h BDh)

This parameter sets a Product ID (PID) value.



NOTE: This parameter applies to customers using a Firmware Flash Update per the Toshiba Global Commerce Solutions (TGCS) Universal Serial Bus OEM Point-of-Sale Device Interface.

To set a Product ID value, scan Set PID Value, and then scan four numeric barcodes in [Numeric Barcodes](#) that correspond to the value. Enter a leading zero for single-digit numbers. To correct an error, or change a selection, scan [Cancel](#). The range is (0, 1600 - 1649).

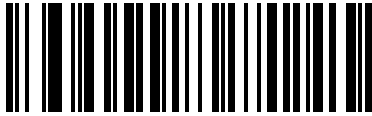


Set PID Value

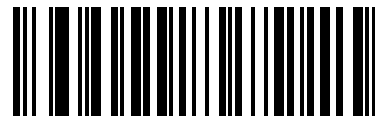
Datalogic Host Format

Parameter # 2253 (SSI # F8 08 CD)

When this parameter is enabled (default), the Datalogic host variant appends a code ID and a suffix value (CR) to the decoded data. When this parameter is disabled, only the decode data is transmitted. These commands are supported over USB CDC.



* Enable (1)



Disable (0)

Datalogic Supported Commands

Parameter # 2260 (SSI # F8 08 D4)

This parameter allows serial scan to enable or disable commands for a standard USB CDC host.

- 'E' or 'e' = Enable Scanning
- 'D' or 'd' = Disable Scanning
- 'R' = Reset the scanner
- 'F' = Indicate to the scanner that Datalogic is not on file
- 'B' = Issue a good read beep
- 1 (Not an ASCII Character – This is a decimal number 1) = Force a good read beep
- 7 (Not an ASCII Character – This is a decimal number 7) = Force a good read beep



Enable (1)



* Disable (0)

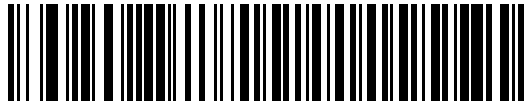
Optional USB Parameters

If you configure the imager and find the settings were not saved, or changed, when the system is restarted scan the barcodes that follow to override USB interface defaults.

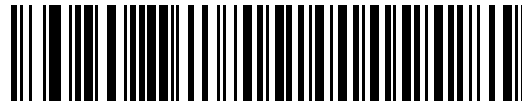
Scan a barcode below after setting defaults and before configuring the imager.

Ignore Beep Directive

The host can send a beep request to the imager. When this parameter is enabled, the request is not sent to the attached imager. All directives are still acknowledged to the USB host as if it were processed.



Disable



*** Enable**

Ignore Barcode Configuration

The host has the ability to enable/disable code types. When this parameter is enabled, the request is not sent to the attached imager. All directives are still acknowledged to the USB host as if it were processed.



Disable



*** Enable**

USB Polling Interval

Scan a barcode below to set the polling interval. The polling interval determines the rate at which data can be sent between the imager and host computer. A lower number indicates a faster data rate.



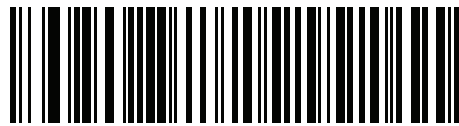
IMPORTANT Ensure your host machine can handle the selected data rate.



NOTE: When changing USB Device Types, the imager automatically restarts and issues a disconnect-reconnect beep sequence.



1 msec



2 msec



*** 3 msec**



4 msec

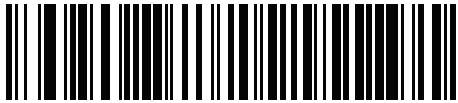
USB Polling Interval (continued)



5 msec



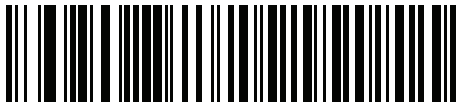
6 msec



7 msec



8 msec



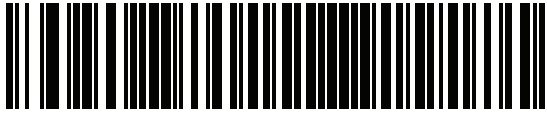
9 msec



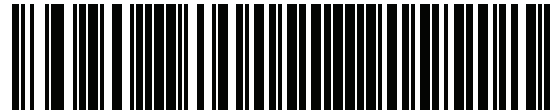
10 msec

USB Fast HID

This option transmits USB HID data at a faster rate.



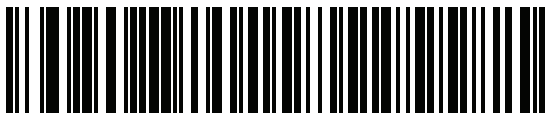
* Enable



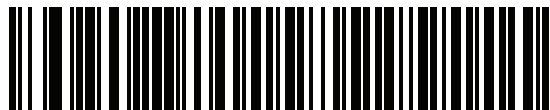
Disable

IBM Specification Version

The IBM USB interface specification version selected defines how code types are reported over the IBM USB interface.



Original Specification



* Version 2.2

ASCII Character Set for USB

See [Numeric Barcodes](#) for the following:

- ASCII Character Set ([Table 33 on page 414](#))
- ALT Key Character Set ([Table 34 on page 418](#))
- GUI Key Character Set ([Table 35 on page 420](#))
- F Key Character Set ([Table 37 on page 423](#))

SSI Interface

Introduction

This chapter describes the system requirements of the Simple Serial Interface (SSI), which provides a communications link between Zebra decoders (e.g., scan engines, slot imagers, Hand-held imagers, two-dimensional imagers, Hands-free imagers, and RF base stations) and a serial host. It provides the means for the host to control the decoder or imager.

Communications

All communication between the digital imager and host occurs over the hardware interface lines using the SSI protocol. Refer to the *Simple Serial Interface Programmer's Guide*, p/n 72-40451-xx, for more information on SSI.

The host and the digital imager exchange messages in packets. A packet is a collection of bytes framed by the proper SSI protocol formatting bytes. The maximum number of bytes per packet that the SSI protocol allows for any transaction is 257 (255 bytes + 2 byte checksum).

Decode data can be sent as ASCII data (unpacketed), or as part of a larger message (packeted), depending on the imager configuration.

SSI performs the following functions for the host device:

- Maintains a bi-directional interface with the imager
- Allows the host to send commands that control the imager
- Passes data from the imager to a host device in SSI packet format or straight decode message.

The working environment of the SSI consists of a digital imager, a serial cable which attaches to the host device, and in some instances, a power supply.

SSI transmits all decode data including special formatting (e.g., AIM ID). Parameter settings can control the format of the transmitted data.

The imager can also send parameter information, product identification information, or event codes to the host.

All commands sent between the imager and host must use the format described in the SSI Message Formats section. [SSI Transactions on page 134](#) describes the required sequence of messages in specific cases.

Table 16 lists all the SSI opcodes the imager supports. It identifies the SSI partner allowed to send a message of each type. The host transmits opcodes designated type H. The imager transmits type D opcodes, and either partner can transmit Host/Decoder (H/D) types.

Table 16 SSI Commands

Name	Type	Opcode	Description
AIM_OFF	H	0xC4	Deactivate aim pattern.
AIM_ON	H	0xC5	Activate aim pattern.
BEEP	H	0xE6	Sound the beeper.
CAPABILITIES_REPLY	D	0xD4	Reply to CAPABILITIES_REQUEST; contains a list of the capabilities and commands the decoder supports.
CAPABILITIES_REQUEST	H	0xD3	Request capabilities report from the decoder.
CMD_ACK	H/D	0xD0	Positive acknowledgment of received packet.
CMD_NAK	H/D	0xD1	Negative acknowledgment of received packet.
DECODE_DATA	D	0xF3	Decode data in SSI packet format.
EVENT	D	0xF6	Event indicated by associated event code.
LED_OFF	H	0xE8	De-activate LED output.
LED_ON	H	0xE7	Activate LED output.
PARAM_DEFAULTS	H	0xC8	Set parameter default values.
PARAM_REQUEST	H	0xC7	Request values of certain parameters.
PARAM_SEND	H/D	0xC6	Send parameter values.
REPLY_REVISION	D	0xA4	Reply to REQUEST_REVISION contains decoder's software/hardware configuration.
REQUEST_REVISION	H	0xA3	Request the decoder's configuration.
SCAN_DISABLE	H	0xEA	Prevent the operator from scanning barcodes.
SCAN_ENABLE	H	0xE9	Permit barcode scanning.
START_DECODE	H	0xE4	Tell decoder to attempt to decode a barcode.
STOP_DECODE	H	0xE5	Tell decoder to abort a decode attempt.
WAKEUP	H	N/A	Wakeup decoder after it has entered low power mode.

For details of the SSI protocol, refer to the *Simple Serial Interface Programmer's Guide (72-40451-xx)*.

SSI Transactions

General Data Transactions

ACK/NAK Handshaking

If you enable ACK/NAK handshaking, all packeted messages must have a CMD_ACK or CMD_NAK response, unless the command description states otherwise. This parameter is enabled by default. Zebra recommends leaving this handshaking enabled to provide feedback to the host. Raw decode data and WAKEUP do not use ACK/NAK handshaking since they are not packeted data.

Following is an example of a problem which can occur if you disable ACK/NAK handshaking:

- The host sends a PARAM_SEND message to the digital imager to change the baud rate from 9600 to 19200.
- The imager cannot interpret the message.
- The imager does not implement the change the host requested.
- The host assumes that the parameter change occurred and acts accordingly.
- Communication is lost because the change did not occur on both sides.

If you enable ACK/NAK handshaking, the following occurs:

- The host sends a PARAM_SEND message.
- The imager cannot interpret the message.
- The imager CMD_NAKs the message.
- The host resends the message.
- The imager receives the message successfully, responds with CMD_ACK, and implements parameter changes.

Transfer of Decode Data

The Decode Data Packet Format parameter controls how decode data is sent to the host. Set this parameter to send the data in a DECODE_DATA packet. Clear this parameter to transmit the data as raw ASCII data.

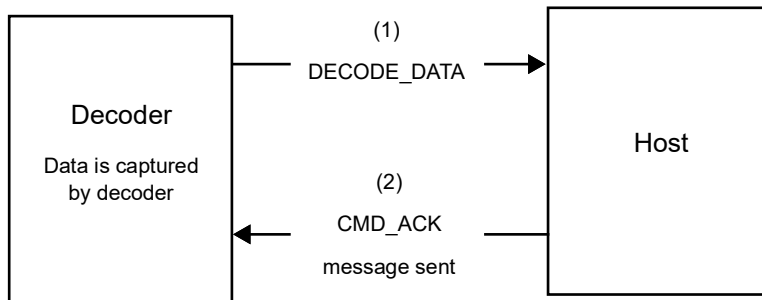


NOTE: When transmitting decode data as raw ASCII data, ACK/NAK handshaking does not apply regardless of the state of the ACK/NAK handshaking parameter.

ACK/NAK Enabled and Packeted Data

The imager sends a DECODE_DATA message after a successful decode. The imager waits for a programmable time-out for a CMD_ACK response. If it does not receive the response, the imager tries to send two more times before issuing a host transmission error. If the imager receives a CMD_NAK from the host, it may attempt a retry depending on the cause field of the CMD_NAK message.

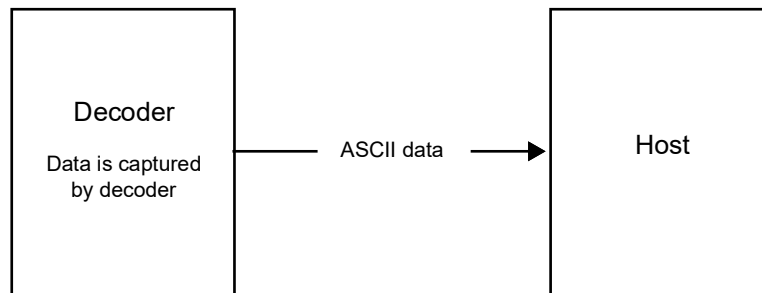
Figure 21 ACK/NAK Enabled and Packeted Data



ACK/NAK Enabled and Unpacketed ASCII Data

Even though the ACK/NAK handshaking is enabled, no handshaking occurs because the handshaking applies only to packeted data. In this example the **packeted_decode** parameter is disabled.

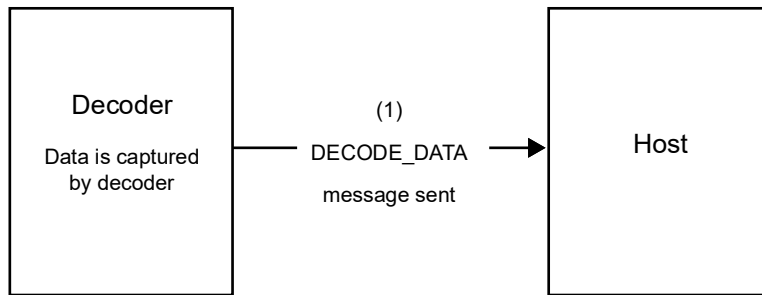
Figure 22 ACK/NAK Enabled and Unpacketed ASCII Data



ACK/NAK Disabled and Packeted DECODE_DATA

In this example ACK/NAK does not occur even though **packeted_decode** is enabled because the ACK/NAK handshaking parameter is disabled.

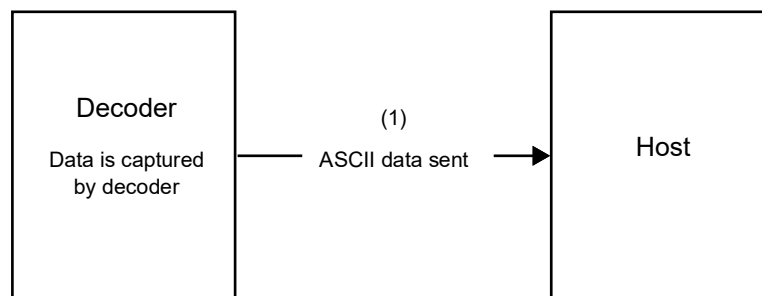
Figure 23 ACK/NAK Disabled and Packeted DECODE_DATA



ACK/NAK Disabled and Unpacketed ASCII Data

Data captured by the imager is sent to the host.

Figure 24 ACK/NAK Disabled and Unpacketed ASCII Data



Communication Summary

ACK/NAK Option

Enable or disable ACK/NAK handshaking. This handshaking is enabled by default and Zebra recommends leaving it enabled. Disabling this handshaking can cause communication problems, as handshaking is the only acknowledgment that a message was received, and if it was received correctly. ACK/NAK is not used with unpacketed decode data regardless of whether or not it is enabled.

Number of Data Bits

All communication with the digital imager must use 8-bit data.

Serial Response Time-out

The Serial Response Time-out parameter determines how long to wait for a handshaking response before trying again, or aborting any further attempts. Set the same value for both the host and digital imager.



NOTE: You can temporarily change the Serial Response Time-out when the host takes longer to process an ACK or longer data string. Zebra does not recommend frequent permanent changes due to limited write cycles of non-volatile memory.

Retries

When sending data, the host should resend twice after the initial send if the imager does not respond with an ACK or NAK (if ACK/NAK handshaking is enabled), or response data (e.g., PARAM_SEND, REPLY_REVISION). If the imager replies with a NAK RESEND, the host resends the data. All resent messages must have the resend bit set in the Status byte.

The imager resends data two times after the initial send if the host fails to reply with an ACK or NAK (if ACK/NAK handshaking is enabled).

Response Time-out and ACK/NAK Handshake

If you use PARAM_SEND to change these serial parameters, the ACK response to the PARAM_SEND uses the previous values for these parameters. The new values then take effect for the next transaction.

Errors

The imager issues a communication error when:

- Failure to receive an ACK or NAK after initial transmit and two resends.

Things to Remember When Using SSI Communication

When using hardware handshaking, frame each message properly with the handshaking signals. Do not try to send two commands within the same handshaking frame.

There is a permanent/temporary bit in the PARAM_SEND message. Removing power from the imager discards temporary changes. Permanent changes are written to non-volatile memory. Frequent changes shorten the life of the non-volatile memory.

Encapsulation of RSM Commands/Responses over SSI

The SSI protocol allows the host to send a command that is variable in length up to 255 bytes. Although there is a provision in the protocol to multi-packet commands from the host, the scan engine does not support this. The host must fragment packets using the provisions in the RSM protocol.

Command Structure

Byte	7	6	5	4	3	2	1	0
0	Length (not including the checksum)							
1	SSI_MGMT_COMMAND (0x80)							
2	Message Source (4 - Host)							
3	Reserved (0)			Reserved (0)		Reserved (0)	Cont'd packet	Retransmit
4	Payload data (see the following example)							
...								
Length -1								
Length	2's complement checksum (MSB)							
Length +1	2's complement checksum (LSB)							

The expected response in the positive case is SSI_MGMT_COMMAND which may be a multi-packet response. For devices that do not support the SSI_MGMT_COMMAND, the response is the standard SSI_NAK.

Response Structure

Byte	7	6	5	4	3	2	1	0
0	Length (not including the checksum)							
1	SSI_MGMT_COMMAND (0x80)							
2	Message Source (0 - Decoder)							
3	Reserved (0)			Reserved (0)		Reserved (0)	Cont'd packet	Retransmit
4	Payload data (see the following example)							
...								
Length -1								
Length	2's complement checksum (MSB)							
Length +1	2's complement checksum (LSB)							

Example Transaction

The following example illustrates how to retrieve diagnostic information (Diagnostic Testing and Reporting (Attribute #10061) decimal) from the engine using encapsulation of RSM commands over SSI. Before sending any RSM command, the host must send the RSM Get Packet Size command to query the packet size supported by the device.

Command from Host to Query Packet Size Supported by Device

```
0A 80 04 00 00 06 20 00 FF FF FD 4E
```

Where:

- 0A 80 04 00 is encapsulation of RSM commands over SSI command header
- 00 06 20 00 FF FF is RSM Get Packet Size command
- FD 4E is SSI command checksum

Response from Device with Packet Size Information

```
0C 80 00 00 00 08 20 00 00 F0 00 F0 FD 6C
```

Where:

- 0C 80 00 00 is encapsulation of RSM command over SSI command header
- 00 08 20 00 00 F0 00 F0 is RSM Get Packet Size response
- FD 6C is SSI response checksum

Command from Host to Retrieve Diagnostic Information

```
0C 80 04 00 00 08 02 00 27 4D 42 00 FE B0
```

Where:

- 0C 80 04 00 is encapsulation of RSM commands over SSI command header
- 00 08 02 00 27 4D 42 00 is attribute Get command requesting attribute 10061 decimal
- FE B0 is SSI command checksum

Response from Device with Diagnostic Information

```
21 80 00 00 00 1D 02 00 27 4D 41 01 42 00 0E 00 00 00 00 01 03 02 03 03 03 04 03 05 03 06 03 FF FF FC 15
```

Where:

- 21 80 00 00 00 1D 02 00 27 4D 41 01 42 00 0E 00 00 is encapsulation of RSM responses over SSI command header
- 00 00 01 03 02 03 03 03 04 03 05 03 06 03 is attribute Get response which includes diagnostic report value
- FF FF is attribute Get response, packet termination
- FC 15 is SSI response checksum

Simple Serial Interface Default Parameters

This section describes how to set up the digital imager with an SSI host. When using SSI, program the imager via barcode menu or SSI hosts commands.

Throughout the programming barcode menus, asterisks (*) indicate default values.



NOTE: Most computer monitors allow scanning the barcodes directly on the screen. When scanning from the screen, be sure to set the document magnification to a level where you can see the barcode clearly, and bars and/or spaces are not merging.

Table 17 lists the defaults for the SSI host. There are two ways to change the default values:

- Scan the appropriate barcodes in this guide. These new values replace the standard default values in memory.
- Download data through the device's serial port using SSI. Hexadecimal parameter numbers appear in this chapter below the parameter title, and options appear in parenthesis beneath the accompanying barcodes. Refer to the *Simple Serial Interface (SSI) Programmer's Guide* for detailed instructions for changing parameters using this method.



NOTE: See [Standard Default Parameters](#) for all user preferences, hosts, symbologies, and default parameters.

Table 17 SSI Default Table

Parameter	Parameter Number	SSI Number	Default	Page Number
Software Handshaking	159	9Fh	ACK/NAK	141
Decode Data Packet Format	238	EEh	Send Raw Decode Data	142
Host Serial Response Time-out	155	9Bh	2 Seconds	143
Host Character Time-out	239	EFh	200 msec	144
Multipacket Option	334	F0h 4Eh	Option 1	145
Interpacket Delay	335	F0h 4Fh	0 msec	146
Event Reporting				
Decode Event	256	F0h 00h	Disable	147
Boot Up Event	258	F0h 02h	Disable	148
Parameter Event	259	F0h 03h	Disable	148

SSI Host Parameters

Software Handshaking

Parameter # 159 (SSI # 9Fh)

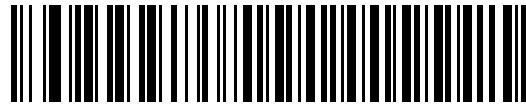
This parameter offers control of data transmission in addition to the control hardware handshaking offers. Hardware handshaking is always enabled; you cannot disable it.

- **Disable ACK/NAK Handshaking:** When this option is selected, the imager neither generates nor expects ACK/NAK handshaking packets.
- **Enable ACK/NAK Handshaking:** When this option is selected, after transmitting data, the digital imager expects either an ACK or NAK response from the host. The imager also ACKs or NAKs messages from the host.

The imager waits up to the programmable Host Serial Response Time-out to receive an ACK or NAK. If the imager does not get a response in this time, it resends its data up to two times before discarding the data and declaring a transmit error.



**Disable ACK/NAK
(0)**



*** Enable ACK/NAK
(1)**

Decode Data Packet Format

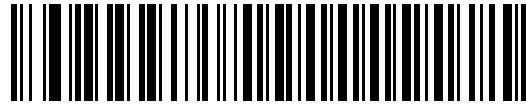
Parameter # 238 (SSI # EEh)

This parameter selects whether to transmit decoded data in raw format (unpacketed), or with the packet format defined by the serial protocol.

Selecting the raw format disables ACK/NAK handshaking for decode data.



*** Send Raw Decode Data
(0)**



**Send Packeted Decode Data
(1)**

Host Serial Response Time-out

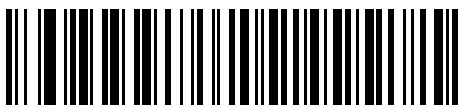
Parameter # 155 (SSI # 9Bh)

This parameter specifies how long the imager waits for an ACK or NAK before resending. Also, if the imager wants to send, and the host has already been granted permission to send, the imager waits for the designated time-out before declaring an error.

To set the delay period (options are 2, 5, 7.5, or 9.9 seconds), scan one of the following barcodes.



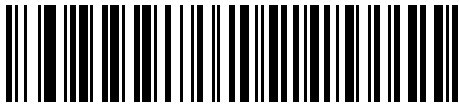
NOTE: Other values are available via SSI command.



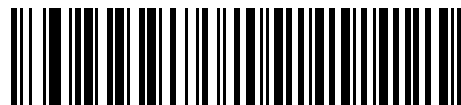
*** Low - 2 Seconds
(20)**



**Medium - 5 Seconds
(50)**



**High - 7.5 Seconds
(75)**



**Maximum - 9.9 Seconds
(99)**

Host Character Time-out

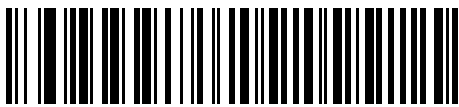
Parameter # 239 (SSI # EFh)

This parameter determines the maximum time the imager waits between characters transmitted by the host before discarding the received data and declaring an error.

To set the delay period (options are 200, 500, 750, or 990 msec), scan one of the following barcodes.



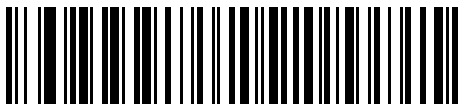
NOTE: Other values are available via SSI command.



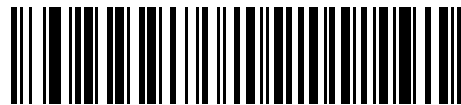
*** Low - 200 msec
(20)**



**Medium - 500 msec
(50)**



**High - 750 msec
(75)**



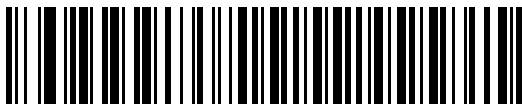
**Maximum - 990 msec
(99)**

Multipacket Option

Parameter # 334 (SSI # F0h 4Eh)

This parameter controls ACK/NAK handshaking for multi-packet transmissions.

- **Multi-Packet Option 1:** The host sends an ACK / NAK for each data packet during a multi-packet transmission.
- **Multi-Packet Option 2:** The imager sends data packets continuously, with no ACK/NAK handshaking to pace the transmission. The host, if overrun, can use hardware handshaking to temporarily delay imager transmissions. At the end of transmission, the imager waits for a CMD_ACK or CMD_NAK.
- **Multi-Packet Option 3:** Option 3 is the same as option 2 with the addition of a programmable interpacket delay.



* Multipacket Option 1
(0)



Multipacket Option 2
(1)



Multipacket Option 3
(2)

Interpacket Delay

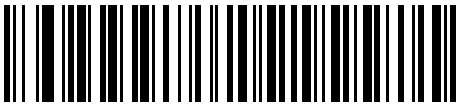
Parameter # 335 (SSI # F0h 4Fh)

This parameter specifies the interpacket delay if you selected **Multipacket Option 3**.

To set the delay period (options are 0, 25, 50, 75, or 99 msec), scan one of the following barcodes.



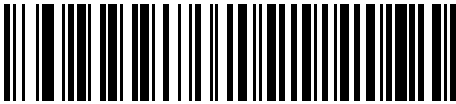
NOTE: Other values are available via SSI command.



* Minimum - 0 msec
(0)



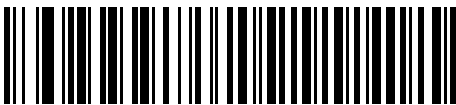
Low - 25 msec
(25)



Medium - 50 msec
(50)



High - 75 msec
(75)



Maximum - 99 msec
(99)

Event Reporting

The host can request the imager to provide certain information (events) relative to the imager's behavior. Enable or disable the events listed in [Table 18](#) and on the following pages by scanning the appropriate barcodes.

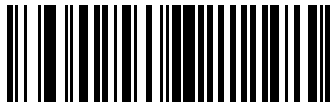
Table 18 Event Codes

Event Class	Event	Code Reported
Decode Event	Non parameter decode	0x01
Boot Up Event	System power-up	0x03
Parameter Event	Parameter entry error	0x07
	Parameter stored	0x08
	Defaults set (and parameter event is enabled by default)	0x0A
	Number expected	0x0F

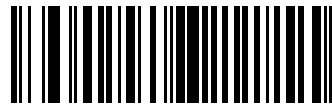
Decode Event

Parameter # 256 (SSI # F0h 00h)

When enabled, the imager generates a message to the host upon a successful barcode decode. When disabled, no notification is sent.



**Enable Decode Event
(1)**

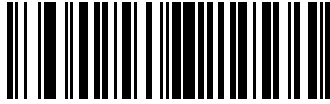


*** Disable Decode Event
(0)**

Boot Up Event

Parameter # 258 (SSI # F0h 02h)

When enabled, the imager generates a message to the host whenever power is applied. When disabled, no notification is sent.



**Enable Boot Up Event
(1)**

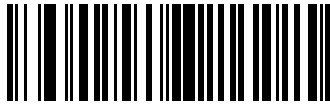


*** Disable Boot Up Event
(0)**

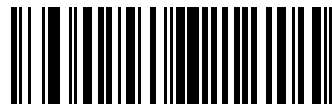
Parameter Event

Parameter # 259 (SSI # F0h 03h)

When enabled, the imager generates a message to the host when one of the events specified in [Table 18 on page 147](#) occurs. When disabled, no notification is sent.



**Enable Parameter Event
(1)**



*** Disable Parameter Event
(0)**

Symbologies

Introduction

This chapter describes symbology features and provides programming barcodes for selecting these features.

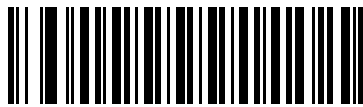
To set feature values, scan a single barcode or a short barcode sequence. The settings are stored in non-volatile memory and are preserved even when the imager powers down.



NOTE: Most computer monitors allow scanning the barcodes directly on the screen. When scanning from the screen, be sure to set the document magnification to a level where you can see the barcode clearly, and bars and/or spaces are not merging.

Select a host type (see each host chapter for specific host information) after the power-up beeps sound. This is only necessary upon the first power-up when connected to a new host.

To return all features to default values, see [Default Parameters on page 59](#). Throughout the programming barcode menus, asterisks (*) indicate default values.



* Indicates Default — * Enable UPC-A — Feature/Option
(1) — Option Value

Scanning Sequence Examples

In most cases, scanning one barcode sets the parameter value. For example, to transmit barcode data without the UPC-A check digit, simply scan the **Do Not Transmit UPC-A Check Digit** barcode under [Transmit UPC-A Check Digit on page 165](#). The imager issues a fast warble beep and the LED turns green, signifying a successful parameter entry.

Other parameters, such as **Set Length(s) for D 2 of 5** require scanning several barcodes. See the individual parameter, such as **Set Length(s) for D 2 of 5**, for this procedure.

Errors While Scanning

Unless otherwise specified, to correct an error during a scanning sequence, just re-scan the correct parameter.

Symbology Parameter Defaults

Table 19 lists the defaults for all symbology parameters. To change the default values, scan the appropriate barcodes in this guide. These new values replace the standard default values in memory. To recall the default parameter values, see [Default Parameters on page 59](#).



NOTE: See [Standard Default Parameters](#) for all user preferences, hosts, and default parameters.

Table 19 Symbology Parameter Defaults

Parameter	Parameter Number	SSI Number	Default	Page Number
Enable/Disable All Code Types				156
1D Symbologies				
UPC/EAN				
UPC-A	1	01h	Enable	157
UPC-E	2	02h	Enable	157
UPC-E1	12	0Ch	Disable	158
EAN-8/JAN 8	4	04h	Enable	158
EAN-13/JAN 13	3	03h	Enable	159
Bookland EAN	83	53h	Disable	159
Decode UPC/EAN/JAN Supplementals (2 and 5 digits)	16	10h	Ignore	160
User-Programmable Supplementals			000	163
Supplemental 1:	579	F1h 43h		
Supplemental 2:	580	F1h 44h		
UPC/EAN/JAN Supplemental Redundancy	80	50h	10	163
Decode UPC/EAN/JAN Supplemental AIM ID Format	672	F1h A0h	Combined	164
UPC Reduced Quiet Zone	1289	F8h 05h 09h	Disable	165
Transmit UPC-A Check Digit	40	28h	Enable	165
Transmit UPC-E Check Digit	41	29h	Enable	166
Transmit UPC-E1 Check Digit	42	2Ah	Enable	166
UPC-A Preamble	34	22h	System Character	167
UPC-E Preamble	35	23h	System Character	168
UPC-E1 Preamble	36	24h	System Character	169
Convert UPC-E to A	37	25h	Disable	170

Table 19 Symbology Parameter Defaults (Continued)

Parameter	Parameter Number	SSI Number	Default	Page Number
Convert UPC-E1 to A	38	26h	Disable	170
EAN-8/JAN-8 Extend	39	27h	Disable	171
Bookland ISBN Format	576	F1h 40h	ISBN-10	171
UCC Coupon Extended Code	85	55h	Disable	172
Coupon Report	730	F1h DAh	New Coupon Format	173
ISSN EAN	617	F1h 69h	Disable	173
Code 128				
Code 128	8	08h	Enable	174
Set Length(s) for Code 128	209, 210	D1h, D2h	1 to 55	175
GS1-128 (formerly UCC/EAN-128)	14	0Eh	Enable	176
ISBT 128	84	54h	Disable	176
ISBT Concatenation	577	F1h 41h	Autodiscriminate	177
Check ISBT Table	578	F1h 42h	Enable	178
ISBT Concatenation Redundancy	223	DFh	10	178
Code 128 Security Level	751	F1h EFh	Security Level 1	179
Code 128 Reduced Quiet Zone	1208	F8h 04h B8h	Disable	180
Ignore Code 128 <FNC4>	1254	F8h 04h E6h	Disable	180
Code 39				
Code 39	0	00h	Enable	181
Trioptic Code 39	13	0Dh	Disable	181
Convert Code 39 to Code 32 (Italian Pharmacy Code)	86	56h	Disable	182
Code 32 Prefix	231	E7h	Disable	182
Set Length(s) for Code 39	18, 19	12h, 13h	1 to 55	183
Code 39 Check Digit Verification	48	30h	Disable	184
Transmit Code 39 Check Digit	43	2Bh	Disable	184
Code 39 Full ASCII Conversion	17	11h	Disable	185
Code 39 Security Level	750	F1h EEh	Security Level 1	186
Code 39 Reduced Quiet Zone	1209	F8h 04h B9h	Disable	187

Table 19 Symbology Parameter Defaults (Continued)

Parameter	Parameter Number	SSI Number	Default	Page Number
Code 93				
Code 93	9	09h	Enable	187
Set Length(s) for Code 93	26, 27	1Ah, 1Bh	1 to 55	188
Code 11				
Code 11	10	0Ah	Disable	189
Set Lengths for Code 11	28, 29	1Ch, 1Dh	4 to 55	190
Code 11 Check Digit Verification	52	34h	Disable	191
Transmit Code 11 Check Digit(s)	47	2Fh	Disable	192
Interleaved 2 of 5 (ITF)				
Interleaved 2 of 5 (ITF)	6	06h	Disable	192
Set Lengths for I 2 of 5	22, 23	16h, 17h	6 to 55	193
I 2 of 5 Check Digit Verification	49	31h	Disable	194
Transmit I 2 of 5 Check Digit	44	2Ch	Disable	195
Convert I 2 of 5 to EAN 13	82	52h	Disable	195
I 2 of 5 Security Level	1121	F8h 04h 61h	Security Level 1	196
I 2 of 5 Reduced Quiet Zone	1210	F8h 04h BAh	Disable	197
Discrete 2 of 5 (DTF)				
Discrete 2 of 5	5	05h	Disable	197
Set Length(s) for D 2 of 5	20, 21	14h 15h	1 to 55	198
Codabar (NW - 7)				
Codabar	7	07h	Enable	199
Set Lengths for Codabar	24, 25	18h, 19h	4 to 55	200
CLSI Editing	54	36h	Disable	201
NOTIS Editing	55	37h	Disable	201
Codabar Upper or Lower Case Start/Stop Characters Detection	855	F2h 57h	Upper Case	202
Codabar Security Level	1776	F8h 06h F0h	Security Level 1	203
Codabar Mod 16 Check Digit Verification	1784	F8h 06h F8h	Disable	204
Transmit Codabar Check Digit	704	F1h C0h	Disable	204
MSI				
MSI	11	0Bh	Disable	205

Table 19 Symbology Parameter Defaults (Continued)

Parameter	Parameter Number	SSI Number	Default	Page Number
Set Length(s) for MSI	30, 31	1Eh, 1Fh	4 to 55	206
MSI Check Digits	50	32h	One	207
Transmit MSI Check Digit(s)	46	2Eh	Disable	207
MSI Check Digit Algorithm	51	33h	Mod 10/Mod 10	208
Chinese 2 of 5				
Chinese 2 of 5	408	F0h 98h	Disable	208
Matrix 2 of 5				
Matrix 2 of 5	618	F1h 6Ah	Disable	209
Matrix 2 of 5 Lengths	619 620	F1h 6Bh F1h 6Ch	4 to 55	210
Matrix 2 of 5 Check Digit	622	F1h 6Eh	Disable	211
Transmit Matrix 2 of 5 Check Digit	623	F1h 6Fh	Disable	211
Korean 3 of 5				
Korean 3 of 5	581	F1h 45h	Disable	212
Inverse 1D	586	F1h 4Ah	Regular	213
GS1 DataBar				
GS1 DataBar-14	338	F0h 52h	Enable	214
GS1 DataBar Limited	339	F0h 53h	Enable	214
GS1 DataBar Expanded	340	F0h 54h	Enable	215
Convert GS1 DataBar to UPC/EAN	397	F0h 8Dh	Disable	215
GS1 DataBar Security Level	1706	F8h 06h AAh	Security Level 1	216
GS1 DataBar Limited Security Level	728	F1h D8h	Level 3	217
GS1 Digital Link				
GS1 Digital Link	2373	F8h 09h 45h	Disable	218
GS1 Digital Link Mode	2374	F8h 09h 46h	Mode 1 (GTIN Only)	218
GS1 Digital Link Prioritization Timeout	2491	F8h 09h BBh	200 ms	219
Composite				
Composite CC-C	341	F0h 55h	Disable	220
Composite CC-A/B	342	F0h 56h	Disable	220
Composite TLC-39	371	F0h 73h	Disable	221
Composite Inverse	1113	F8h 04h 59h	Regular Only	221

Table 19 Symbology Parameter Defaults (Continued)

Parameter	Parameter Number	SSI Number	Default	Page Number
UPC Composite Mode	344	F0h 58h	UPC Never Linked	222
Composite Beep Mode	398	F0h 8Eh	Beep As Each Code Type is Decoded	223
GS1-128 Emulation Mode for UCC/EAN Composite Codes	427	F0h ABh	Disable	223
2D Symbologies				
PDF417	15	0Fh	Enable	224
MicroPDF417	227	E3h	Disable	224
Code 128 Emulation	123	7Bh	Disable	225
Data Matrix	292	F0h 24h	Enable	226
GS1 Data Matrix	1336	F8h 05h 38h	Disable	226
Data Matrix Inverse	588	F1h 4Ch	Inverse Autodetect	227
Maxicode	294	F0h 26h	Disable	227
QR Code	293	F0h 25h	Enable	228
GS1 QR	1343	F8h 05h 3Fh	Disable	228
MicroQR	573	F1h 3Dh	Enable	229
Linked QR Mode	1847	737h	Linked QR Only	229
Aztec	574	F1h 3Eh	Enable	230
Aztec Inverse	589	F1h 4Dh	Inverse Autodetect	230
Han Xin	1167	F8h 04h 8Fh	Disable	231
Han Xin Inverse	1168	F8h 04h 90h	Regular	231
Grid Matrix	1718	F8 06h B6h	Disable	232
Grid Matrix Inverse	1719	F8h 06h B7h	Regular Only	232
Grid Matrix Mirrored	1736	F8h 06h C8h	Non-Mirrored Only	233
DotCode	1906	F8 07 72h	Disable	234
DotCode Inverse	1907	F8 07 73h	Autodetect	234
DotCode Mirrored	1908	F8 07 74h	Autodetect	235
DotCode Prioritize	1937	F8 07 91h	Disable	235
DotCode Erasure Limit	2063	F8 08 0F	10	236
Postal Codes				
US Postnet	89	59h	Disable	237

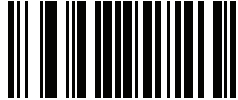
Table 19 Symbology Parameter Defaults (Continued)

Parameter	Parameter Number	SSI Number	Default	Page Number
US Planet	90	5Ah	Disable	237
Transmit US Postal Check Digit	95	5Fh	Enable	238
UK Postal	91	5Bh	Disable	238
Transmit UK Postal Check Digit	96	60h	Enable	239
Japan Postal	290	F0h 22h	Disable	239
Australia Post	291	F0h 23h	Disable	240
Australia Post Format	718	F1h CEh	Autodiscriminate	241
Netherlands KIX Code	326	F0h 46h	Disable	242
USPS 4CB/One Code/Intelligent Mail	592	F1h 50h	Disable	242
UPU FICS Postal	611	F1h 63h	Disable	243
Mailmark	1337	F8h 05h 39h	Disable	243
Symbology-Specific Security Levels				
Redundancy Level	78	4Eh	1	244
Security Level	77	4Dh	1	246
1D Quiet Zone Level	1288	F8h 05h 08h	1	247
Intercharacter Gap Size	381	F0h 7Dh	Normal	248
Report Version				248
Macro PDF				
Flush Macro PDF Buffer	N/A	N/A	N/A	249
Abort Macro PDF Entry	N/A	N/A	N/A	249

Enable/Disable All Code Types

To disable all symbologies, scan **Disable All Code Types** below. This is useful when enabling only a few code types.

Scan **Enable All Code Types** turn on (enable) all code types. This is useful when you want to read all codes, or when you want to disable only a few code types.



Disable All Code Types



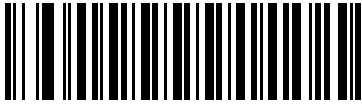
Enable All Code Types

UPC/EAN

Enable/Disable UPC-A

Parameter # 1 (SSI # 01h)

To enable or disable UPC-A, scan the appropriate barcode below.



*** Enable UPC-A
(1)**

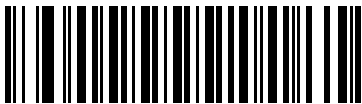


**Disable UPC-A
(0)**

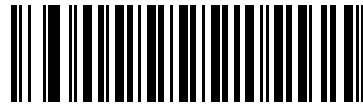
Enable/Disable UPC-E

Parameter # 2 (SSI # 02h)

To enable or disable UPC-E, scan the appropriate barcode below.



*** Enable UPC-E
(1)**



**Disable UPC-E
(0)**

Enable/Disable UPC-E1

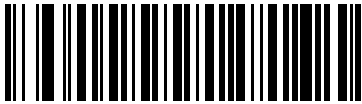
Parameter # 12 (SSI # 0Ch)

UPC-E1 is disabled by default.

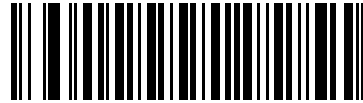
To enable or disable UPC-E1, scan the appropriate barcode below.



NOTE: UPC-E1 is not a UCC (Uniform Code Council) approved symbology.



**Enable UPC-E1
(1)**

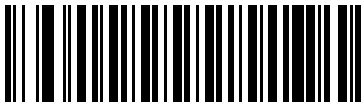


*** Disable UPC-E1
(0)**

Enable/Disable EAN-8/JAN-8

Parameter # 4 (SSI # 04h)

To enable or disable EAN-8/JAN-8, scan the appropriate barcode below.



*** Enable EAN-8/JAN-8
(1)**

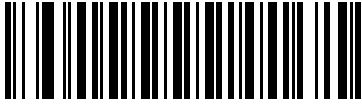


**Disable EAN-8/JAN-8
(0)**

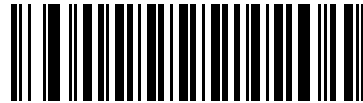
Enable/Disable EAN-13/JAN-13

Parameter # 3 (SSI # 03h)

To enable or disable EAN-13/JAN-13, scan the appropriate barcode below.



*** Enable EAN-13/JAN-13
(1)**

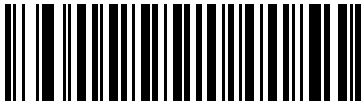


**Disable EAN-13/JAN-13
(0)**

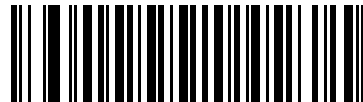
Enable/Disable Bookland EAN

Parameter # 83 (SSI # 53h)

To enable or disable Bookland EAN, scan the appropriate barcode below.



**Enable Bookland EAN
(1)**



*** Disable Bookland EAN
(0)**



NOTE: If you enable Bookland EAN, select a [Bookland ISBN Format on page 171](#). Also select either Decode UPC/EAN Supplementals, Autodiscriminate UPC/EAN Supplementals, or Enable 978/979 Supplemental Mode in [Decode UPC/EAN/JAN Supplementals on page 160](#).

Decode UPC/EAN/JAN Supplementals

Parameter # 16 (SSI # 10h)

Supplementals are barcodes appended according to specific format conventions (e.g., UPC A+2, UPC E+2, EAN 13+2). The following options are available:

- If you select **Ignore UPC/EAN with Supplementals**, and the imager is presented with a UPC/EAN plus supplemental symbol, the imager decodes UPC/EAN and ignores the supplemental characters.
- If you select **Decode UPC/EAN with Supplementals**, the imager only decodes UPC/EAN symbols with supplemental characters, and ignores symbols without supplementals.
- If you select **Autodiscriminate UPC/EAN Supplementals**, the imager decodes UPC/EAN symbols with supplemental characters immediately. If the symbol does not have a supplemental, the imager must decode the barcode the number of times set via [UPC/EAN/JAN Supplemental Redundancy on page 163](#) before transmitting its data to confirm that there is no supplemental.
- If you select one of the following **Supplemental Mode** options, the imager immediately transmits EAN-13 barcodes starting with that prefix that have supplemental characters. If the symbol does not have a supplemental, the imager must decode the barcode the number of times set via [UPC/EAN/JAN Supplemental Redundancy on page 163](#) before transmitting its data to confirm that there is no supplemental. The digital scanner transmits UPC/EAN barcodes that do not have that prefix immediately.
 - **Enable 378/379 Supplemental Mode**
 - **Enable 978/979 Supplemental Mode**



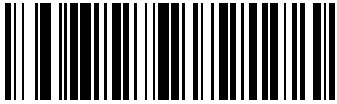
NOTE: If you select 978/979 Supplemental Mode and are scanning Bookland EAN barcodes, see [Enable/Disable Bookland EAN on page 159](#) to enable Bookland EAN, and select a format using [Bookland ISBN Format on page 171](#).

- **Enable 977 Supplemental Mode**
- **Enable 414/419/434/439 Supplemental Mode**
- **Enable 491 Supplemental Mode**
- **Enable Smart Supplemental Mode** - applies to EAN-13 barcodes starting with any prefix listed previously.
- **Supplemental User-Programmable Type 1** - applies to EAN-13 barcodes starting with a 3-digit user-defined prefix. Set this 3-digit prefix using [User-Programmable Supplementals on page 163](#).
- **Supplemental User-Programmable Type 1 and 2** - applies to EAN-13 barcodes starting with either of two 3-digit user-defined prefixes. Set the 3-digit prefixes using [User-Programmable Supplementals on page 163](#).
- **Smart Supplemental Plus User-Programmable 1** - applies to EAN-13 barcodes starting with any prefix listed previously or the user-defined prefix set using [User-Programmable Supplementals on page 163](#).
- **Smart Supplemental Plus User-Programmable 1 and 2** - applies to EAN-13 barcodes starting with any prefix listed previously or one of the two user-defined prefixes set using [User-Programmable Supplementals on page 163](#).



NOTE: To minimize the risk of invalid data transmission, select either to decode or ignore supplemental characters.

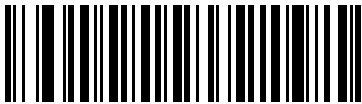
Decode UPC/EAN/JAN Supplementals (continued)



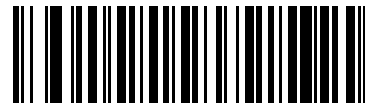
**Decode UPC/EAN/JAN Only With Supplementals
(1)**



*** Ignore Supplementals
(0)**



**Autodiscriminate UPC/EAN/JAN Supplementals
(2)**



**Enable 378/379 Supplemental Mode
(4)**

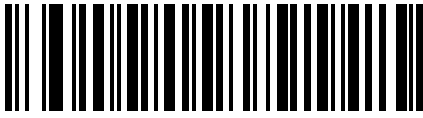


**Enable 978/979 Supplemental Mode
(5)**



**Enable 977 Supplemental Mode
(7)**

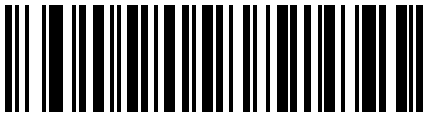
Decode UPC/EAN/JAN Supplementals (continued)



Enable 414/419/434/439 Supplemental Mode
(6)



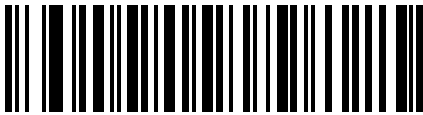
Enable 491 Supplemental Mode
(8)



Enable Smart Supplemental Mode
(3)



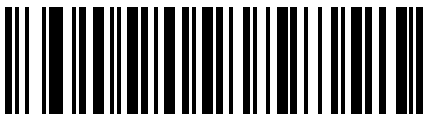
Supplemental User-Programmable Type 1
(9)



Supplemental User-Programmable Type 1 and 2
(10)



Smart Supplemental Plus User-Programmable 1
(11)



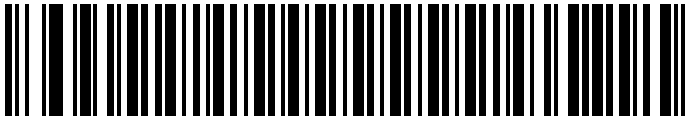
Smart Supplemental Plus User-Programmable 1 and 2
(12)

User-Programmable Supplementals

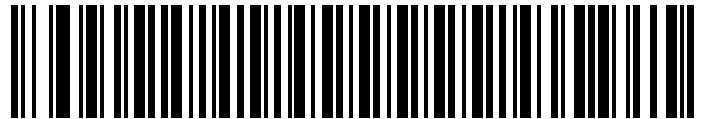
Supplemental 1: Parameter # 579 (SSI # F1h 43h)

Supplemental 2: Parameter # 580 (SSI # F1h 44h)

If you selected a Supplemental User-Programmable option from [Decode UPC/EAN/JAN Supplementals on page 160](#), select **User-Programmable Supplemental 1** to set the 3-digit prefix. Then select the 3 digits using the numeric barcodes beginning on [Numeric Barcodes on page 412](#). Select **User-Programmable Supplemental 2** to set a second 3-digit prefix. Then select the 3 digits using the numeric barcodes beginning on [Numeric Barcodes on page 412](#). The default is 000 (zeroes).



User-Programmable Supplemental 1



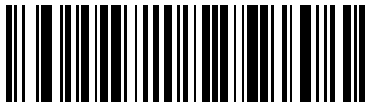
User-Programmable Supplemental 2

UPC/EAN/JAN Supplemental Redundancy

Parameter # 80 (SSI # 50h)

If you selected **Autodiscriminate UPC/EAN/JAN Supplementals**, this option adjusts the number of times to decode a symbol without supplementals before transmission. The range is from two to thirty times. Five or above is recommended when decoding a mix of UPC/EAN/JAN symbols with and without supplementals. The default is 10.

Scan the barcode below to set a decode redundancy value. Next, scan two numeric barcodes in [Numeric Barcodes](#). Enter a leading zero for single digit numbers. To correct an error or change a selection, scan [Cancel on page 413](#).



UPC/EAN/JAN Supplemental Redundancy

UPC/EAN/JAN Supplemental AIM ID Format

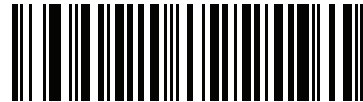
Parameter # 672 (SSI # F1h A0h)

Select an output format when reporting UPC/EAN/JAN barcodes with Supplementals with [Transmit Code ID Character on page 80](#) set to **AIM Code ID Character**:

- **Separate** - transmit UPC/EAN with supplementals with separate AIM IDs but one transmission, i.e.:
]E<0 or 4><data>]E<1 or 2>[supplemental data]
- **Combined** – transmit UPC/EAN with supplementals with one AIM ID and one transmission, i.e.:
]E3<data+supplemental data>
- **Separate Transmissions** - transmit UPC/EAN with supplementals with separate AIM IDs and separate transmissions, i.e.:
]E<0 or 4><data>
]E<1 or 2>[supplemental data]



Separate
(0)



*** Combined**
(1)



Separate Transmissions
(2)

UPC Reduced Quiet Zone

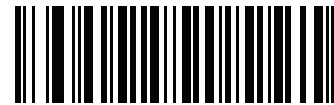
Parameter # 1289 (SSI # F8h 05h 09h)

Scan one of the following barcodes to enable or disable decoding UPC barcodes with reduced quiet zones. If you select **Enable**, select a [1D Quiet Zone Level on page 247](#).



Enable UPC Reduced Quiet Zone

(1)



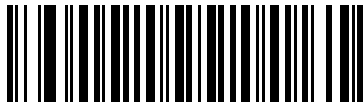
*** Disable UPC Reduced Quiet Zone**

(0)

Transmit UPC-A Check Digit

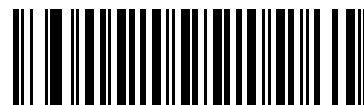
Parameter # 40 (SSI # 28h)

The check digit is the last character of the symbol used to verify the integrity of the data. Scan the appropriate barcode below to transmit the barcode data with or without the UPC-A check digit. It is always verified to guarantee the integrity of the data.



*** Transmit UPC-A Check Digit**

(1)



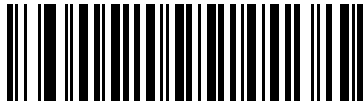
Do Not Transmit UPC-A Check Digit

(0)

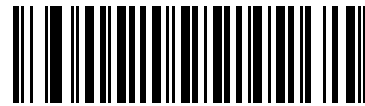
Transmit UPC-E Check Digit

Parameter # 41 (SSI # 29h)

The check digit is the last character of the symbol used to verify the integrity of the data. Scan the appropriate barcode below to transmit the barcode data with or without the UPC-E check digit. It is always verified to guarantee the integrity of the data.



*** Transmit UPC-E Check Digit
(1)**

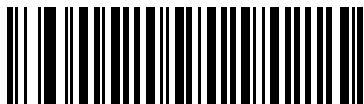


**Do Not Transmit UPC-E Check Digit
(0)**

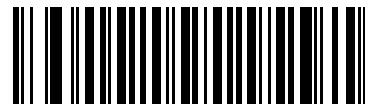
Transmit UPC-E1 Check Digit

Parameter # 42 (SSI # 2Ah)

The check digit is the last character of the symbol used to verify the integrity of the data. Scan the appropriate barcode below to transmit the barcode data with or without the UPC-E1 check digit. It is always verified to guarantee the integrity of the data.



*** Transmit UPC-E1 Check Digit
(1)**



**Do Not Transmit UPC-E1 Check Digit
(0)**

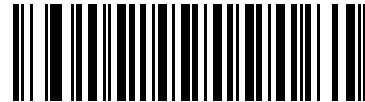
UPC-A Preamble

Parameter # 34 (SSI # 22h)

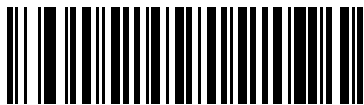
Preamble characters are part of the UPC symbol, and include Country Code and System Character. There are three options for transmitting a UPC-A preamble to the host device: transmit System Character only, transmit System Character and Country Code ("0" for USA), and transmit no preamble. Select the appropriate option to match the host system.



No Preamble (<DATA>
(0)



* System Character (<SYSTEM CHARACTER>
<DATA>
(1)

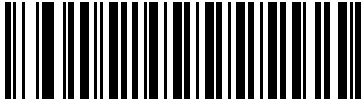


System Character & Country Code
(< COUNTRY CODE> <SYSTEM CHARACTER>
<DATA>
(2)

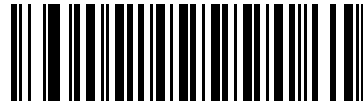
UPC-E Preamble

Parameter # 35 (SSI # 23h)

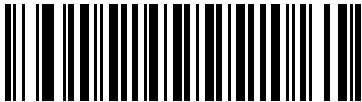
Preamble characters are part of the UPC symbol, and include Country Code and System Character. There are three options for transmitting a UPC-E preamble to the host device: transmit System Character only, transmit System Character and Country Code ("0" for USA), and transmit no preamble. Select the appropriate option to match the host system.



No Preamble (<DATA>
(0)



* System Character (<SYSTEM CHARACTER>
<DATA>
(1)



System Character & Country Code
(< COUNTRY CODE> <SYSTEM CHARACTER>
<DATA>
(2)

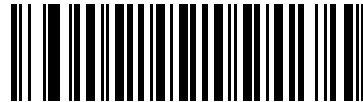
UPC-E1 Preamble

Parameter # 36 (SSI # 24h)

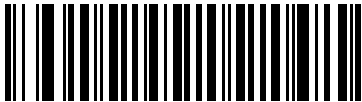
Preamble characters are part of the UPC symbol, and include Country Code and System Character. There are three options for transmitting a UPC-E1 preamble to the host device: transmit System Character only, transmit System Character and Country Code ("0" for USA), and transmit no preamble. Select the appropriate option to match the host system.



No Preamble (<DATA>
(0)



* System Character (<SYSTEM CHARACTER>
<DATA>
(1)



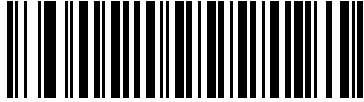
System Character & Country Code
(< COUNTRY CODE> <SYSTEM CHARACTER>
<DATA>
(2)

Convert UPC-E to UPC-A

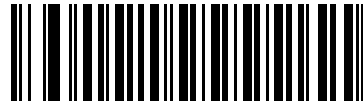
Parameter # 37 (SSI # 25h)

Enable this to convert UPC-E (zero suppressed) decoded data to UPC-A format before transmission. After conversion, the data follows UPC-A format and is affected by UPC-A programming selections (e.g., Preamble, Check Digit).

Disable this to transmit UPC-E decoded data as UPC-E data, without conversion.



Convert UPC-E to UPC-A (Enable)
(1)



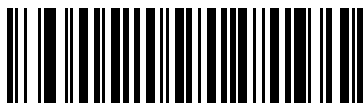
*** Do Not Convert UPC-E to UPC-A (Disable)**
(0)

Convert UPC-E1 to UPC-A

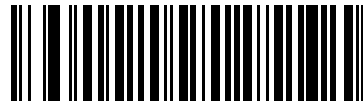
Parameter # 38 (SSI # 26h)

Enable this to convert UPC-E1 decoded data to UPC-A format before transmission. After conversion, the data follows UPC-A format and is affected by UPC-A programming selections (e.g., Preamble, Check Digit).

Disable this to transmit UPC-E1 decoded data as UPC-E1 data, without conversion.



Convert UPC-E1 to UPC-A (Enable)
(1)

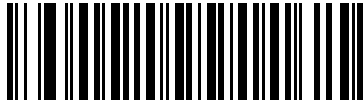


*** Do Not Convert UPC-E1 to UPC-A (Disable)**
(0)

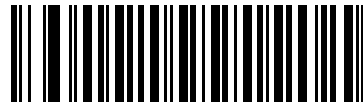
EAN-8/JAN-8 Extend

Parameter # 39 (SSI # 27h)

Enable this parameter to add five leading zeros to decoded EAN-8 symbols to make them compatible in format to EAN-13 symbols. Disable this to transmit EAN-8 symbols as is.



**Enable EAN/JAN Zero Extend
(1)**



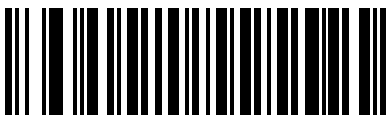
*** Disable EAN/JAN Zero Extend
(0)**

Bookland ISBN Format

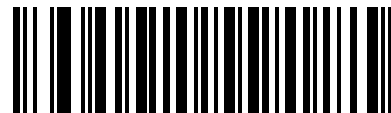
Parameter # 576 (SSI # F1h 40h)

If you enabled Bookland EAN using [Enable/Disable Bookland EAN on page 159](#), select one of the following formats for Bookland data:

- **Bookland ISBN-10** - The digital scanner reports Bookland data starting with 978 in traditional 10-digit format with the special Bookland check digit for backward-compatibility. Data starting with 979 is not considered Bookland in this mode.
- **Bookland ISBN-13** - The digital scanner reports Bookland data (starting with either 978 or 979) as EAN-13 in 13-digit format to meet the 2007 ISBN-13 protocol.



*** Bookland ISBN-10
(0)**



**Bookland ISBN-13
(1)**



NOTE: Most computer monitors allow scanning the barcodes directly on the screen. When scanning from the screen, be sure to set the document magnification to a level where you can see the barcode clearly, and bars and/or spaces are not merging.

UCC Coupon Extended Code

Parameter # 85 (SSI # 55h)

Enable this parameter to decode UPC-A barcodes starting with digit '5', EAN-13 barcodes starting with digit '99', and UPC-A/GS1-128 Coupon Codes. UPCA, EAN-13, and GS1-128 must be enabled to scan all types of Coupon Code.



**Enable UCC Coupon Extended Code
(1)**



*** Disable UCC Coupon Extended Code
(0)**



NOTE: See [UPC/EAN/JAN Supplemental Redundancy on page 163](#) to control autodiscrimination of the GS1-128 (right half) of a coupon code.

Coupon Report

Parameter # 730 (SSI # F1h DAh)

Select an option to determine which type of coupon format to support.

- Select **Old Coupon Format** to support UPC-A/GS1-128 and EAN-13/GS1-128.
- Select **New Coupon Format** as an interim format to support UPC-A/GS1-DataBar and EAN-13/GS1-DataBar.
- If you select **Autodiscriminate Format**, the digital scanner supports both **Old Coupon Format** and **New Coupon Format**.



Old Coupon Format
(0)



*** New Coupon Format**
(1)



Autodiscriminate Coupon Format
(2)

ISSN EAN

Parameter # 617 (SSI # F1h 69h)

To enable or disable ISSN EAN, scan the appropriate barcode below.



Enable ISSN EAN
(1)



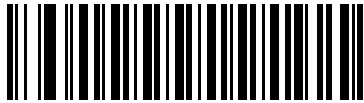
*** Disable ISSN EAN**
(0)

Code 128

Enable/Disable Code 128

Parameter # 8 (SSI # 08h)

To enable or disable Code 128, scan the appropriate barcode below.



*** Enable Code 128
(1)**



**Disable Code 128
(0)**

Set Lengths for Code 128

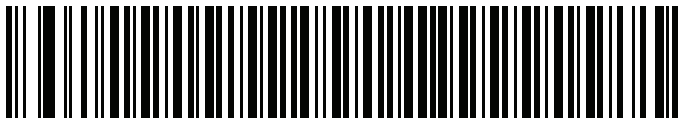
Parameter # L1 = 209 (SSI # D1h), L2 = 210 (SSI # D2h)

The length of a code refers to the number of characters (i.e., human readable characters), including check digit(s) the code contains. Set lengths for Code 128 to any length, one or two discrete lengths, or lengths within a specific range. The default is 1 to 55.

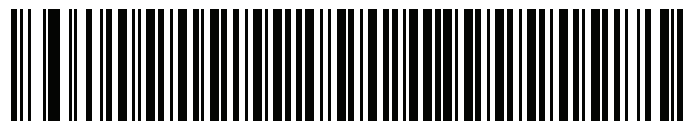


NOTE: When setting lengths for different barcode types, enter a leading zero for single digit numbers.

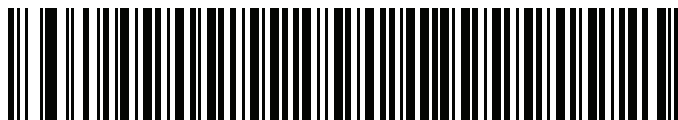
- **One Discrete Length** - Select this option to decode only Code 128 symbols containing a selected length. Select the length using the numeric barcodes in [Numeric Barcodes](#). For example, to decode only Code 128 symbols with 14 characters, scan Code 128 - One Discrete Length, then scan 1 followed by 4. To correct an error or change the selection, scan [Cancel on page 413](#).
- **Two Discrete Lengths** - Select this option to decode only Code 128 symbols containing either of two selected lengths. Select lengths using the numeric barcodes in [Numeric Barcodes](#). For example, to decode only Code 128 symbols containing either 2 or 14 characters, select Code 128 - Two Discrete Lengths, then scan 0, 2, 1, and then 4. To correct an error or change the selection, scan [Cancel on page 413](#).
- **Length Within Range** - Select this option to decode a Code 128 symbol with a specific length range. Select lengths using numeric barcodes in [Numeric Barcodes](#). For example, to decode Code 128 symbols containing between 4 and 12 characters, first scan Code 128 - Length Within Range. Then scan 0, 4, 1, and 2 (enter a leading zero for single digit numbers). To correct an error or change the selection, scan [Cancel on page 413](#).
- **Any Length** - Select this option to decode Code 128 symbols containing any number of characters within the digital scanner's capability.



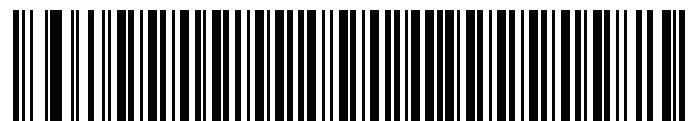
Code 128 - One Discrete Length



Code 128 - Two Discrete Lengths



Code 128 - Length Within Range

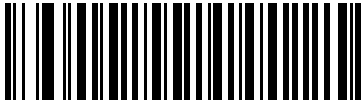


Code 128 - Any Length

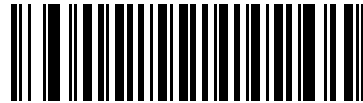
Enable/Disable GS1-128 (formerly UCC/EAN-128)

Parameter # 14 (SSI # 0Eh)

To enable or disable GS1-128, scan the appropriate barcode below.



*** Enable GS1-128
(1)**



**Disable GS1-128
(0)**

Enable/Disable ISBT 128

Parameter # 84 (SSI # 54h)

ISBT 128 is a variant of Code 128 used in the blood bank industry. Scan a barcode below to enable or disable ISBT 128. If necessary, the host must perform concatenation of the ISBT data.



**Enable ISBT 128
(1)**



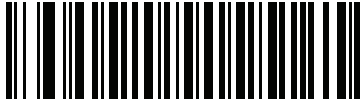
*** Disable ISBT 128
(0)**

ISBT Concatenation

Parameter # 577 (SSI # F1h 41h)

Select an option for concatenating pairs of ISBT code types:

- If you select **Disable ISBT Concatenation**, the imager does not concatenate pairs of ISBT codes it encounters.
- If you select **Enable ISBT Concatenation**, there must be two ISBT codes in order for the imager to decode and perform concatenation. The imager does not decode single ISBT symbols.
- If you select **Autodiscriminate ISBT Concatenation**, the imager decodes and concatenates pairs of ISBT codes immediately. If only a single ISBT symbol is present, the imager must decode the symbol the number of times set via [ISBT Concatenation Redundancy on page 178](#) before transmitting its data to confirm that there is no additional ISBT symbol.



**Disable ISBT Concatenation
(0)**



**Enable ISBT Concatenation
(1)**



*** Autodiscriminate ISBT Concatenation
(2)**

Check ISBT Table

Parameter # 578 (SSI # F1h 42h)

The ISBT specification includes a table that lists several types of ISBT barcodes that are commonly used in pairs. If you set **ISBT Concatenation** to **Enable**, enable **Check ISBT Table** to concatenate only those pairs found in this table. Other types of ISBT codes are not concatenated.



* Enable Check ISBT Table
(1)



Disable Check ISBT Table
(0)

ISBT Concatenation Redundancy

Parameter # 223 (SSI # DFh)

If you set **ISBT Concatenation** to **Autodiscriminate**, use this parameter to set the number of times the digital scanner must decode an ISBT symbol before determining that there is no additional symbol.

Scan the barcode below, then scan two numeric barcodes in [Numeric Barcodes](#) to set a value between 2 and 20. Enter a leading zero for single digit numbers. To correct an error or change a selection, scan [Cancel on page 413](#). The default is 10.



ISBT Concatenation Redundancy

Code 128 Security Level

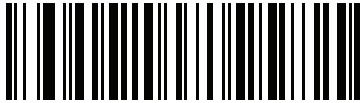
Parameter # 751 (SSI # F1h EFh)

Code 128 barcodes are vulnerable to misdecodes, particularly when Code 128 Lengths is set to **Any Length**. The imager offers four levels of decode security for Code 128 barcodes. There is an inverse relationship between security and imager aggressiveness. Increasing the level of security can reduce scanning aggressiveness, so select only the level of security necessary.

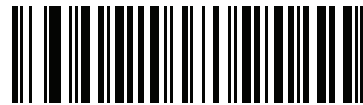
- **Code 128 Security Level 0:** This setting allows the imager to operate in its most aggressive state, while providing sufficient security in decoding most in-spec barcodes.
- **Code 128 Security Level 1:** A barcode must be successfully read twice, and satisfy certain safety requirements before being decoded. This default setting eliminates most misdecodes.
- **Code 128 Security Level 2:** Select this option with greater barcode security requirements if **Security Level 1** fails to eliminate misdecodes.
- **Code 128 Security Level 3:** If you selected **Security Level 2**, and misdecodes still occur, select this security level to apply the highest safety requirements. A barcode must be successfully read three times before being decoded.



NOTE: Selecting this option is an extreme measure against mis-decoding severely out-of-spec barcodes. Selecting this level of security significantly impairs the decoding ability of the digital scanner. If this level of security is required, try to improve the quality of the barcodes.



Code 128 Security Level 0
(0)



* Code 128 Security Level 1
(1)



Code 128 Security Level 2
(2)



Code 128 Security Level 3
(3)

Code 128 Reduced Quiet Zone

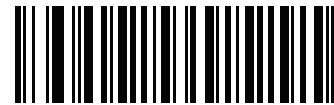
Parameter # 1208 (SSI # F8h 04h B8h)

Scan one of the following barcodes to enable or disable decoding Code 128 barcodes with reduced quiet zones. If you select **Enable**, select a [1D Quiet Zone Level on page 247](#).



Enable Code 128 Reduced Quiet Zone

(1)



*** Disable Code 128 Reduced Quiet Zone**

(0)

Ignore Code 128 <FNC4>

Parameter # 1254 (SSI # F8h 04h E6h)

This feature applies to Code 128 barcodes with an embedded <FNC4> character. Enable this to strip the <FNC4> character from the decode data. The remaining characters are sent to the host unchanged. When disabled, the <FNC4> character is processed normally as per Code 128 standard.



Enable Ignore Code 128 <FNC4>

(1)



*** Disable Ignore Code 128 <FNC4>**

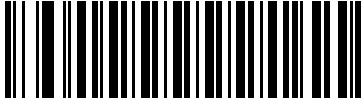
(0)

Code 39

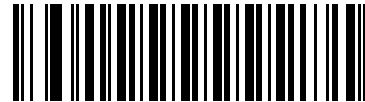
Enable/Disable Code 39

Parameter # 0 (SSI # 00h)

To enable or disable Code 39, scan the appropriate barcode below.



*** Enable Code 39**
(1)

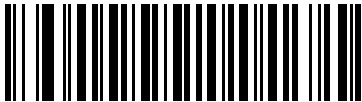


Disable Code 39
(0)

Enable/Disable Trioptic Code 39

Parameter # 13 (SSI # 0Dh)

Trioptic Code 39 is a variant of Code 39 used in the marking of computer tape cartridges. Trioptic Code 39 symbols always contain six characters. To enable or disable Trioptic Code 39, scan the appropriate barcode below.



Enable Trioptic Code 39
(1)



*** Disable Trioptic Code 39**
(0)



NOTE: You cannot enable Trioptic Code 39 and Code 39 Full ASCII simultaneously.

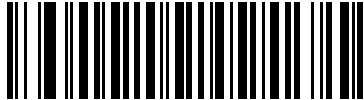
Convert Code 39 to Code 32

Parameter # 86 (SSI # 56h)

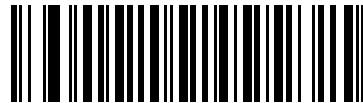
Code 32 is a variant of Code 39 used by the Italian pharmaceutical industry. Scan the appropriate barcode below to enable or disable converting Code 39 to Code 32.



NOTE: Code 39 must be enabled for this parameter to function.



Enable Convert Code 39 to Code 32
(1)



*** Disable Convert Code 39 to Code 32**
(0)

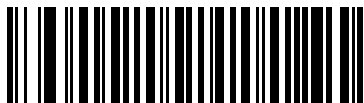
Code 32 Prefix

Parameter # 231 (SSI # E7h)

Scan the appropriate barcode below to enable or disable adding the prefix character “A” to all Code 32 barcodes.



NOTE: Convert Code 39 to Code 32 must be enabled for this parameter to function.



Enable Code 32 Prefix
(1)



*** Disable Code 32 Prefix**
(0)

Set Lengths for Code 39

Parameter # L1 = 18 (SSI # 12h), L2 = 19 (SSI # 13h)

The length of a code refers to the number of characters (i.e., human readable characters), including check digit(s) the code contains. Set lengths for Code 39 to any length, one or two discrete lengths, or lengths within a specific range. If Code 39 Full ASCII is enabled, **Length Within a Range** or **Any Length** are the preferred options. The default is 1 to 55.

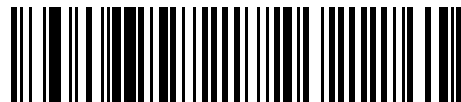


NOTE: When setting lengths for different barcode types, enter a leading zero for single digit numbers.

- **One Discrete Length** - Select this option to decode only Code 39 symbols containing a selected length. Select the length using the numeric barcodes in [Numeric Barcodes](#). For example, to decode only Code 39 symbols with 14 characters, scan Code 39 - One Discrete Length, then scan 1 followed by 4. To correct an error or change the selection, scan [Cancel on page 413](#).
- **Two Discrete Lengths** - Select this option to decode only Code 39 symbols containing either of two selected lengths. Select lengths using the numeric barcodes in [Numeric Barcodes](#). For example, to decode only Code 39 symbols containing either 2 or 14 characters, select Code 39 - Two Discrete Lengths, then scan 0, 2, 1, and then 4. To correct an error or change the selection, scan [Cancel on page 413](#).
- **Length Within Range** - Select this option to decode a Code 39 symbol with a specific length range. Select lengths using numeric barcodes in [Numeric Barcodes](#). For example, to decode Code 39 symbols containing between 4 and 12 characters, first scan Code 39 - Length Within Range. Then scan 0, 4, 1, and 2 (enter a leading zero for single digit numbers). To correct an error or change the selection, scan [Cancel on page 413](#).
- **Any Length** - Select this option to decode Code 39 symbols containing any number of characters within the digital scanner's capability.



Code 39 - One Discrete Length



Code 39 - Two Discrete Lengths



Code 39 - Length Within Range

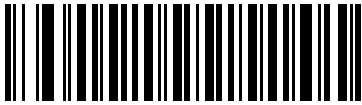


Code 39 - Any Length

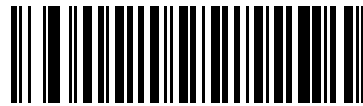
Code 39 Check Digit Verification

Parameter # 48 (SSI # 30h)

Enable this feature to check the integrity of all Code 39 symbols to verify that the data complies with specified check digit algorithm. Only Code 39 symbols which include a modulo 43 check digit are decoded. Enable this feature if the Code 39 symbols contain a Modulo 43 check digit.



Enable Code 39 Check Digit
(1)



*** Disable Code 39 Check Digit**
(0)

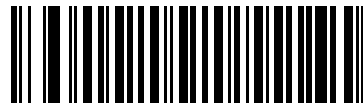
Transmit Code 39 Check Digit

Parameter # 43 (SSI # 2Bh)

Scan a barcode below to transmit Code 39 data with or without the check digit.



Transmit Code 39 Check Digit (Enable)
(1)



*** Do Not Transmit Code 39 Check Digit (Disable)**
(0)



NOTE: Code 39 Check Digit Verification must be enabled for this parameter to function.

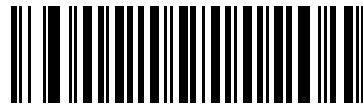
Code 39 Full ASCII Conversion

Parameter # 17 (SSI # 11h)

Code 39 Full ASCII is a variant of Code 39 which pairs characters to encode the full ASCII character set. To enable or disable Code 39 Full ASCII, scan the appropriate barcode below.



**Enable Code 39 Full ASCII
(1)**



*** Disable Code 39 Full ASCII
(0)**



NOTE You cannot enable Trioptic Code 39 and Code 39 Full ASCII simultaneously.

Code 39 Full ASCII to Full ASCII Correlation is host-dependent, and is therefore described in the ASCII Character Set Table for the appropriate interface. See [ASCII](#).

Code 39 Security Level

Parameter # 750 (SSI # F1h EEh)

The imager offers four levels of decode security for Code 39 barcodes. There is an inverse relationship between security and imager aggressiveness. Increasing the level of security can reduce scanning aggressiveness, so select only the level of security necessary.

- **Code 39 Security Level 0:** This setting allows the digital scanner to operate in its most aggressive state, while providing sufficient security in decoding most in-spec barcodes.
- **Code 39 Security Level 1:** This default setting eliminates most misdecodes.
- **Code 39 Security Level 2:** Select this option with greater barcode security requirements if **Security Level 1** fails to eliminate misdecodes.
- **Code 39 Security Level 3:** If you selected **Security Level 2**, and misdecodes still occur, select this security level to apply the highest safety requirements.



NOTE: Selecting this option is an extreme measure against mis-decoding severely out-of-spec barcodes. Selecting this level of security significantly impairs the decoding ability of the digital scanner. If this level of security is required, try to improve the quality of the barcodes.



Code 39 Security Level 0
(0)



*** Code 39 Security Level 1**
(1)



Code 39 Security Level 2
(2)



Code 39 Security Level 3
(3)

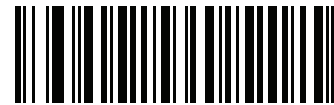
Code 39 Reduced Quiet Zone

Parameter # 1209 (SSI # F8h 04h B9h)

Scan one of the following barcodes to enable or disable decoding Code 39 barcodes with reduced quiet zones. If you select **Enable**, select a [1D Quiet Zone Level on page 247](#).



**Enable Code 39 Reduced Quiet Zone
(1)**



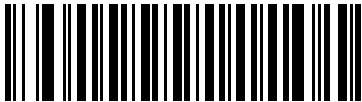
*** Disable Code 39 Reduced Quiet Zone
(0)**

Code 93

Enable/Disable Code 93

Parameter # 9 (SSI # 09h)

To enable or disable Code 93, scan the appropriate barcode below.



*** Enable Code 93
(1)**



**Disable Code 93
(0)**

Set Lengths for Code 93

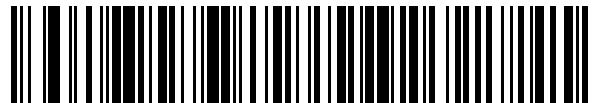
Parameter # L1 = 26 (SSI # 1Ah), L2 = 27 (SSI # 1Bh)

The length of a code refers to the number of characters (i.e., human readable characters), including check digit(s) the code contains. Set lengths for Code 93 to any length, one or two discrete lengths, or lengths within a specific range. The default is 1 to 55.

- **One Discrete Length** - Select this option to decode only Code 93 symbols containing a selected length. Select the length using the numeric barcodes in [Numeric Barcodes](#). For example, to decode only Code 93 symbols with 14 characters, scan Code 93 - One Discrete Length, then scan 1 followed by 4. To correct an error or to change the selection, scan [Cancel on page 413](#).
- **Two Discrete Lengths** - Select this option to decode only Code 93 symbols containing either of two selected lengths. Select lengths using the numeric barcodes in [Numeric Barcodes](#). For example, to decode only Code 93 symbols containing either 2 or 14 characters, select Code 93 - Two Discrete Lengths, then scan 0, 2, 1, and then 4. To correct an error or to change the selection, scan [Cancel on page 413](#).
- **Length Within Range** - Select this option to decode a Code 93 symbol with a specific length range. Select lengths using the numeric barcodes in [Numeric Barcodes](#). For example, to decode Code 93 symbols containing between 4 and 12 characters, first scan Code 93 - Length Within Range. Then scan 0, 4, 1, and 2 (enter a leading zero for single digit numbers). To correct an error or change the selection, scan [Cancel on page 413](#).
- **Any Length** - Scan this option to decode Code 93 symbols containing any number of characters within the digital scanner's capability.



Code 93 - One Discrete Length



Code 93 - Two Discrete Lengths



Code 93 - Length Within Range



Code 93 - Any Length

Code 11

Code 11

Parameter # 10 (SSI # 0Ah)

To enable or disable Code 11, scan the appropriate barcode below.



Enable Code 11
(1)



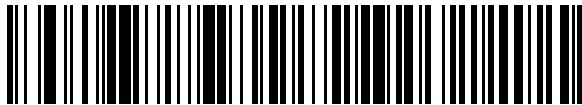
*** Disable Code 11**
(0)

Set Lengths for Code 11

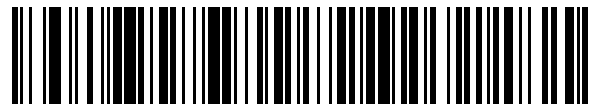
Parameter # L1 = 28 (SSI # 1Ch), L2 = 29 (SSI # 1Dh)

The length of a code refers to the number of characters (i.e., human readable characters), including check digit(s) the code contains. Set lengths for Code 11 to any length, one or two discrete lengths, or lengths within a specific range. The default is 4 to 55.

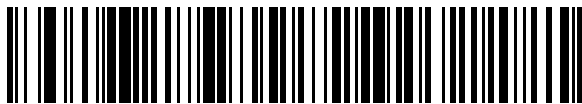
- **One Discrete Length** - Select this option to decode only Code 11 symbols containing a selected length. Select the length using the numeric barcodes in [Numeric Barcodes](#). For example, to decode only Code 11 symbols with 14 characters, scan Code 11 - One Discrete Length, then scan 1 followed by 4. To correct an error or to change the selection, scan [Cancel on page 413](#).
- **Two Discrete Lengths** - Select this option to decode only Code 11 symbols containing either of two selected lengths. Select lengths using the numeric barcodes in [Numeric Barcodes](#). For example, to decode only Code 11 symbols containing either 2 or 14 characters, select Code 11 - Two Discrete Lengths, then scan 0, 2, 1, and then 4. To correct an error or to change the selection, scan [Cancel on page 413](#).
- **Length Within Range** - Select this option to decode a Code 11 symbol with a specific length range. Select lengths using numeric barcodes in [Numeric Barcodes](#). For example, to decode Code 11 symbols containing between 4 and 12 characters, first scan Code 11 - Length Within Range. Then scan 0, 4, 1, and 2 (enter a leading zero for single digit numbers). To correct an error or change the selection, scan [Cancel on page 413](#).
- **Any Length** - Scan this option to decode Code 11 symbols containing any number of characters within the digital scanner's capability.



Code 11 - One Discrete Length



Code 11 - Two Discrete Lengths



Code 11 - Length Within Range



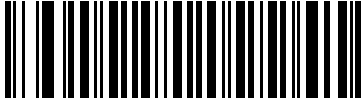
Code 11 - Any Length

Code 11 Check Digit Verification

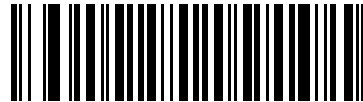
Parameter # 52 (SSI # 34h)

This feature allows the imager to check the integrity of all Code 11 symbols to verify that the data complies with the specified check digit algorithm. This selects the check digit mechanism for the decoded Code 11 barcode. The options are to check for one check digit, check for two check digits, or disable the feature.

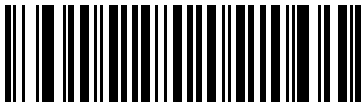
To enable this feature, scan the barcode below corresponding to the number of check digits encoded in the Code 11 symbols.



*** Disable**
(0)



One Check Digit
(1)

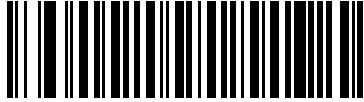


Two Check Digits
(2)

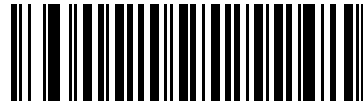
Transmit Code 11 Check Digit(s)

Parameter # 47 (SSI # 2Fh)

This feature selects whether or not to transmit the Code 11 check digit(s).



Transmit Code 11 Check Digit(s) (Enable)
(1)



*** Do Not Transmit Code 11 Check Digit(s) (Disable)**
(0)



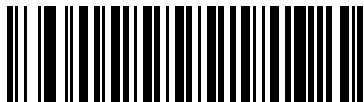
NOTE: Code 11 Check Digit Verification must be enabled for this parameter to function.

Interleaved 2 of 5 (ITF)

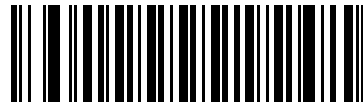
Enable/Disable Interleaved 2 of 5

Parameter # 6 (SSI # 06h)

To enable or disable Interleaved 2 of 5, scan the appropriate barcode below, and select an Interleaved 2 of 5 length from the following pages.



Enable Interleaved 2 of 5
(1)



*** Disable Interleaved 2 of 5**
(0)

Set Lengths for Interleaved 2 of 5

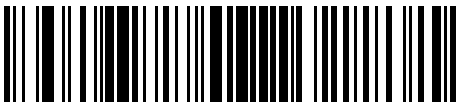
Parameter # L1 = 22 (SSI # 16h), L2 = 23 (SSI # 17h)

The length of a code refers to the number of characters (i.e., human readable characters), including check digit(s) the code contains. Set lengths for I 2 of 5 to any length, one or two discrete lengths, or lengths within a specific range. The range for Interleaved 2 of 5 lengths is 0 - 55. The default is 6 to 55.

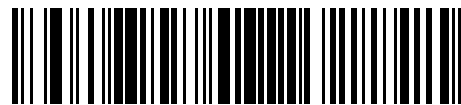
- **One Discrete Length** - Select this option to decode only I 2 of 5 symbols containing a selected length. Select the length using the numeric barcodes in [Numeric Barcodes](#). For example, to decode only I 2 of 5 symbols with 14 characters, scan I 2 of 5 - One Discrete Length, then scan 1 followed by 4. To correct an error or to change the selection, scan [Cancel on page 413](#).
- **Two Discrete Lengths** - Select this option to decode only I 2 of 5 symbols containing either of two selected lengths. Select lengths using the numeric barcodes in [Numeric Barcodes](#). For example, to decode only I 2 of 5 symbols containing either 2 or 14 characters, select I 2 of 5 - Two Discrete Lengths, then scan 0, 2, 1, and then 4. To correct an error or to change the selection, scan [Cancel on page 413](#).
- **Length Within Range** - Select this option to decode an I 2 of 5 symbol with a specific length range. Select lengths using numeric barcodes in [Numeric Barcodes](#). For example, to decode I 2 of 5 symbols containing between 4 and 12 characters, first scan I 2 of 5 - Length Within Range. Then scan 0, 4, 1, and 2 (enter a leading zero for single digit numbers). To correct an error or change the selection, scan [Cancel on page 413](#).
- **Any Length** - Scan this option to decode I 2 of 5 symbols containing any number of characters within the digital scanner's capability.



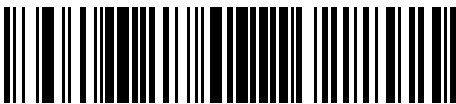
NOTE: Due to the construction of the I 2 of 5 symbology, it is possible for a scan covering only a portion of the code to transmit as a complete scan, yielding less data than is encoded in the barcode. To prevent this, select specific lengths (I 2 of 5 - One Discrete Length, Two Discrete Lengths) for I 2 of 5 applications.



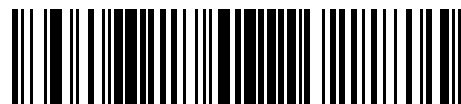
I 2 of 5 - One Discrete Length



I 2 of 5 - Two Discrete Lengths



I 2 of 5 - Length Within Range



I 2 of 5 - Any Length

I 2 of 5 Check Digit Verification

Parameter # 49 (SSI # 31h)

Enable this feature to check the integrity of all I 2 of 5 symbols to verify the data complies with either the specified Uniform Symbology Specification (USS), or the Optical Product Code Council (OPCC) check digit algorithm.



*** Disable**
(0)



USS Check Digit
(1)

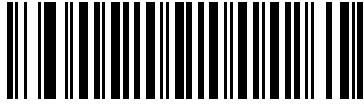


OPCC Check Digit
(2)

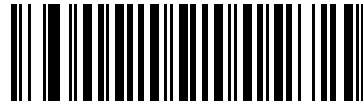
Transmit I 2 of 5 Check Digit

Parameter # 44 (SSI # 2Ch)

Scan the appropriate barcode below to transmit I 2 of 5 data with or without the check digit.



Transmit I 2 of 5 Check Digit (Enable)
(1)

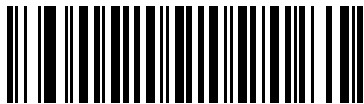


*** Do Not Transmit I 2 of 5 Check Digit (Disable)**
(0)

Convert I 2 of 5 to EAN-13

Parameter # 82 (SSI # 52h)

Enable this parameter to convert 14-character I 2 of 5 codes to EAN-13, and transmit to the host as EAN-13. To accomplish this, the I 2 of 5 code must be enabled, and the code must have a leading zero and a valid EAN-13 check digit.



Convert I 2 of 5 to EAN-13 (Enable)
(1)



*** Do Not Convert I 2 of 5 to EAN-13 (Disable)**
(0)

I 2 of 5 Security Level

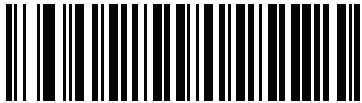
Parameter # 1121 (SSI # F8h 04h 61h)

Interleaved 2 of 5 barcodes are vulnerable to misdecodes, particularly when I 2 of 5 Lengths is set to **Any Length**. The imager offers four levels of decode security for Interleaved 2 of 5 barcodes. There is an inverse relationship between security and imager aggressiveness. Increasing the level of security can reduce scanning aggressiveness, so select only the level of security necessary.

- **I 2 of 5 Security Level 0:** This setting allows the imager to operate in its most aggressive state, while providing sufficient security in decoding most in-spec barcodes.
- **I 2 of 5 Security Level 1:** A barcode must be successfully read twice, and satisfy certain safety requirements before being decoded. This default setting eliminates most misdecodes.
- **I 2 of 5 Security Level 2:** Select this option with greater barcode security requirements if **Security Level 1** fails to eliminate misdecodes.
- **I 2 of 5 Security Level 3:** If you selected **Security Level 2**, and misdecodes still occur, select this security level. The highest safety requirements are applied. A barcode must be successfully read three times before being decoded.



NOTE: Selecting this option is an extreme measure against mis-decoding severely out-of-spec barcodes. Selecting this level of security significantly impairs the decoding ability of the digital scanner. If this level of security is required, try to improve the quality of the barcodes.



I 2 of 5 Security Level 0
(0)



* I 2 of 5 Security Level 1
(1)



I 2 of 5 Security Level 2
(2)



I 2 of 5 Security Level 3
(3)

I 2 of 5 Reduced Quiet Zone

Parameter # 1210 (SSI # F8h 04h BAh)

Scan one of the following barcodes to enable or disable decoding I 2 of 5 barcodes with reduced quiet zones. If you select **Enable**, select a [1D Quiet Zone Level on page 247](#).



Enable I 2 of 5 Reduced Quiet Zone
(1)



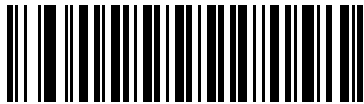
* Disable I 2 of 5 Reduced Quiet Zone
(0)

Discrete 2 of 5 (DTF)

Enable/Disable Discrete 2 of 5

Parameter # 5 (SSI # 05h)

To enable or disable Discrete 2 of 5, scan the appropriate barcode below.



Enable Discrete 2 of 5
(1)



* Disable Discrete 2 of 5
(0)

Set Lengths for Discrete 2 of 5

Parameter # L1 = 20 (SSI # 14h), L2 = 21 (SSI # 15h)

The length of a code refers to the number of characters (i.e., human readable characters), including check digit(s) the code contains. Set lengths for D 2 of 5 to any length, one or two discrete lengths, or lengths within a specific range. The range for Discrete 2 of 5 lengths is 1 - 55.

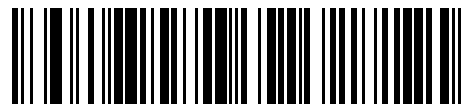
- **One Discrete Length** - Select this option to decode only D 2 of 5 symbols containing a selected length. Select the length using the numeric barcodes in [Numeric Barcodes](#). For example, to decode only D 2 of 5 symbols with 14 characters, scan D 2 of 5 - One Discrete Length, then scan 1 followed by 4. To correct an error or to change the selection, scan [Cancel on page 413](#).
- **Two Discrete Lengths** - Select this option to decode only D 2 of 5 symbols containing either of two selected lengths. Select lengths using the numeric barcodes in [Numeric Barcodes](#). For example, to decode only D 2 of 5 symbols containing either 2 or 14 characters, select D 2 of 5 - Two Discrete Lengths, then scan 0, 2, 1, and then 4. To correct an error or to change the selection, scan [Cancel on page 413](#).
- **Length Within Range** - Select this option to decode a D 2 of 5 symbol with a specific length range. Select lengths using numeric barcodes in [Numeric Barcodes](#). For example, to decode D 2 of 5 symbols containing between 4 and 12 characters, first scan D 2 of 5 - Length Within Range. Then scan 0, 4, 1, and 2 (enter a leading zero for single digit numbers). To correct an error or change the selection, scan [Cancel on page 413](#).
- **Any Length** - Scan this option to decode D 2 of 5 symbols containing any number of characters within the digital scanner's capability.



NOTE: Due to the construction of the D 2 of 5 symbology, it is possible for a scan covering only a portion of the code to transmit as a complete scan, yielding less data than is encoded in the barcode. To prevent this, select specific lengths (D 2 of 5 - One Discrete Length, Two Discrete Lengths) for D 2 of 5 applications.



D 2 of 5 - One Discrete Length



D 2 of 5 - Two Discrete Lengths



D 2 of 5 - Length Within Range



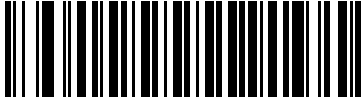
D 2 of 5 - Any Length

Codabar (NW - 7)

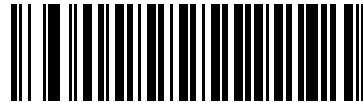
Enable/Disable Codabar

Parameter # 7 (SSI # 07h)

To enable or disable Codabar, scan the appropriate barcode below.



*** Enable Codabar
(1)**



**Disable Codabar
(0)**

Set Lengths for Codabar

Parameter # L1 = 24 (SSI # 18h), L2 = 25 (SSI # 19h)

The length of a code refers to the number of characters (i.e., human readable characters), including check digit(s) the code contains. Set lengths for Codabar to any length, one or two discrete lengths, or lengths within a specific range. The default is 4 to 55.

- **One Discrete Length** - Select this option to decode only Codabar symbols containing a selected length. Select the length using the numeric barcodes in [Numeric Barcodes](#). For example, to decode only Codabar symbols with 14 characters, scan Codabar - One Discrete Length, then scan 1 followed by 4. To correct an error or to change the selection, scan [Cancel on page 413](#).
- **Two Discrete Lengths** - Select this option to decode only Codabar symbols containing either of two selected lengths. Select lengths using the numeric barcodes in [Numeric Barcodes](#). For example, to decode only Codabar symbols containing either 2 or 14 characters, select Codabar - Two Discrete Lengths, then scan 0, 2, 1, and then 4. To correct an error or to change the selection, scan [Cancel on page 413](#).
- **Length Within Range** - Select this option to decode a Codabar symbol with a specific length range. Select lengths using numeric barcodes in [Numeric Barcodes](#). For example, to decode Codabar symbols containing between 4 and 12 characters, first scan Codabar - Length Within Range. Then scan 0, 4, 1, and 2 (enter a leading zero for single digit numbers). To correct an error or change the selection, scan [Cancel on page 413](#).
- **Any Length** - Scan this option to decode Codabar symbols containing any number of characters within the digital scanner's capability.



Codabar - One Discrete Length



Codabar - Two Discrete Lengths



Codabar - Length Within Range



Codabar - Any Length

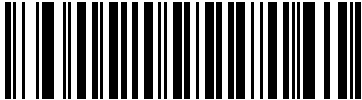
CLSI Editing

Parameter # 54 (SSI # 36h)

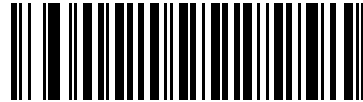
Enable this parameter to strip the start and stop characters and insert a space after the first, fifth, and tenth characters of a 14-character Codabar symbol. Enable this feature if the host system requires this data format.



NOTE: Symbol length does not include start and stop characters.



**Enable CLSI Editing
(1)**



*** Disable CLSI Editing
(0)**

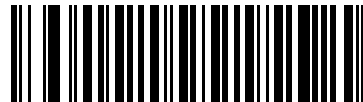
NOTIS Editing

Parameter # 55 (SSI # 37h)

Enable this parameter to strip the start and stop characters from a decoded Codabar symbol. Enable this feature if the host system requires this data format.



**Enable NOTIS Editing
(1)**

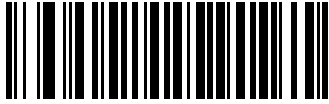


*** Disable NOTIS Editing
(0)**

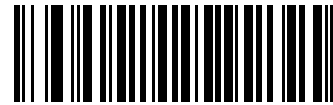
Codabar Upper or Lower Case Start/Stop Characters Detection

Parameter # 855 (SSI # F2h 57h)

Select whether to detect upper case or lower case Codabar start/stop characters.



Lower Case
(1)



*** Upper Case**
(0)

Codabar Security Level

Parameter # 1776 (SSI # F8h 06h F0h)

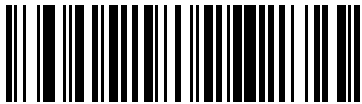
This parameter sets the security level for Codabar 39.

The scanner offers four levels of decode security for Codabar barcodes. There is an inverse relationship between security and scanner aggressiveness. Increasing the level of security can reduce scanning aggressiveness, so select only the level of security necessary.

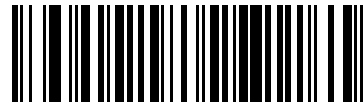
- Codabar Security Level 0: This setting allows the scanner to operate in its most aggressive state, while providing sufficient security in decoding most in-spec barcodes.
- Codabar Security Level 1: This default setting eliminates most misdecodes.
- Codabar Security Level 2: Select this option with greater barcode security requirements if Security Level 1 fails to eliminate misdecodes.
- Codabar Security Level 3: If you selected Security Level 2, and misdecodes still occur, select this security level to apply the highest safety requirements.



NOTE: Selecting this option is an extreme measure against mis-decoding severely out-of-spec barcodes, and significantly impairs the decoding ability of the scanner. If this level of security is required, try to improve the quality of the barcodes.



Codabar Security Level 0 (0)



* Codabar Security Level 1 (1)



Codabar Security Level 2 (2)



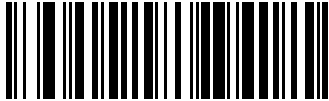
Codabar Security Level 3 (3)

Codabar Mod 16 Check Digit Verification

Parameter # 1784 (SSI # F8h 06h F8h)

This parameter checks the Codabar Mod 16 check digit to verify that the data complies with the specified check digit algorithm.

- Enabled - enables check digit
- *Disabled - disables check digit



Enable Codabar Mod 16 Check digit (1)



*** Disable Codabar Mod 16 Check digit (0)**

Transmit Codabar Check Digit

Parameter # 704 (SSI #F1h C0h)

This parameter selects whether or not to transmit the Codabar check digit(s).

- Enabled - enables check digit transmission.
- Enabled - disables check digit transmission.



Enable Codabar Check Digit Transmission (1)



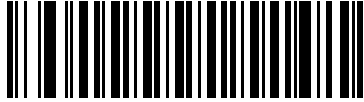
***Disable Codabar Check Digit Transmission (0)**

MSI

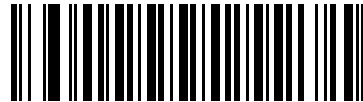
Enable/Disable MSI

Parameter # 11 (SSI # 0Bh)

To enable or disable MSI, scan the appropriate barcode below.



Enable MSI
(1)



*** Disable MSI**
(0)

Set Lengths for MSI

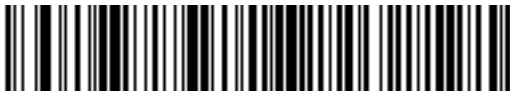
Parameter # L1 = 30 (SSI # 1Eh), L2 = 31 (SSI # 1Fh)

The length of a code refers to the number of characters (i.e., human readable characters), including check digit(s) the code contains. Set lengths for MSI to any length, one or two discrete lengths, or lengths within a specific range. The default is 4 to 55.

- **One Discrete Length** - Select this option to decode only MSI symbols containing a selected length. Select the length using the numeric barcodes in [Numeric Barcodes](#). For example, to decode only MSI symbols with 14 characters, scan MSI - One Discrete Length, then scan 1 followed by 4. To correct an error or to change the selection, scan [Cancel on page 413](#).
- **Two Discrete Lengths** - Select this option to decode only MSI symbols containing either of two selected lengths. Select lengths using the numeric barcodes in [Numeric Barcodes](#). For example, to decode only MSI symbols containing either 2 or 14 characters, select MSI - Two Discrete Lengths, then scan 0, 2, 1, and then 4. To correct an error or to change the selection, scan [Cancel on page 413](#).
- **Length Within Range** - Select this option to decode a MSI symbol with a specific length range. Select lengths using numeric barcodes in [Numeric Barcodes](#). For example, to decode MSI symbols containing between 4 and 12 characters, first scan MSI - Length Within Range. Then scan 0, 4, 1, and 2 (enter a leading zero for single digit numbers). To correct an error or change the selection, scan [Cancel on page 413](#).
- **Any Length** - Scan this option to decode MSI symbols containing any number of characters within the digital scanner's capability.



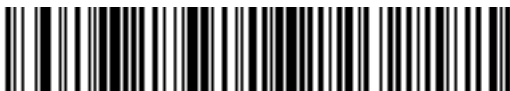
NOTE: Due to the construction of the MSI symbology, it is possible for a scan covering only a portion of the code to transmit as a complete scan, yielding less data than is encoded in the barcode. To prevent this, select specific lengths (**MSI - One Discrete Length, Two Discrete Lengths**) for MSI applications.



MSI - One Discrete Length



MSI - Two Discrete Lengths



MSI - Length Within Range



MSI - Any Length

MSI Check Digits

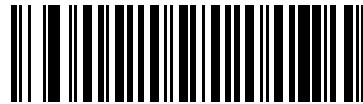
Parameter # 50 (SSI # 32h)

With MSI symbols, one check digit is mandatory and always verified by the reader. The second check digit is optional. If the MSI codes include two check digits, scan the **Two MSI Check Digits** barcode to enable verification of the second check digit.

See [MSI Check Digit Algorithm on page 208](#) for the selection of second digit algorithms.



* One MSI Check Digit
(0)



Two MSI Check Digits
(1)

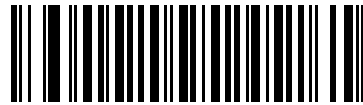
Transmit MSI Check Digit(s)

Parameter # 46 (SSI # 2Eh)

Scan a barcode below to transmit MSI data with or without the check digit.



Transmit MSI Check Digit(s) (Enable)
(1)



* Do Not Transmit MSI Check Digit(s) (Disable)
(0)

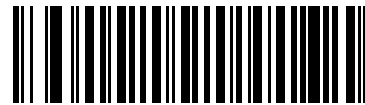
MSI Check Digit Algorithm

Parameter # 51 (SSI # 33h)

Two algorithms are possible for the verification of the second MSI check digit. Select the barcode below corresponding to the algorithm used to encode the check digit.



MOD 10/MOD 11
(0)



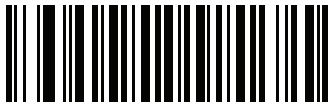
*** MOD 10/MOD 10**
(1)

Chinese 2 of 5

Enable/Disable Chinese 2 of 5

Parameter # 408 (SSI # F0h 98h)

To enable or disable Chinese 2 of 5, scan the appropriate barcode below.



Enable Chinese 2 of 5
(1)



*** Disable Chinese 2 of 5**
(0)

Matrix 2 of 5

Enable/Disable Matrix 2 of 5

Parameter # 618 (SSI # F1h 6Ah)

To enable or disable Matrix 2 of 5, scan the appropriate barcode below.



**Enable Matrix 2 of 5
(1)**



*** Disable Matrix 2 of 5
(0)**

Set Lengths for Matrix 2 of 5

Parameter # L1 = 619 (SSI # F1h 6Bh), L2 = 620 (SSI # F1h 6Ch)

The length of a code refers to the number of characters (i.e., human readable characters), including check digit(s) the code contains. Set lengths for Matrix 2 of 5 to any length, one or two discrete lengths, or lengths within a specific range. The default is 4 to 55.

- **One Discrete Length** - Select this option to decode only Matrix 2 of 5 symbols containing a selected length. Select the length using the numeric barcodes in [Numeric Barcodes](#). For example, to decode only Matrix 2 of 5 symbols with 14 characters, scan Matrix 2 of 5 - One Discrete Length, then scan 1 followed by 4. To correct an error or to change the selection, scan [Cancel on page 413](#).
- **Two Discrete Lengths** - Select this option to decode only Matrix 2 of 5 symbols containing either of two selected lengths. Select lengths using the numeric barcodes in [Numeric Barcodes](#). For example, to decode only Matrix 2 of 5 symbols containing either 2 or 14 characters, select Matrix 2 of 5 - Two Discrete Lengths, then scan 0, 2, 1, and then 4. To correct an error or to change the selection, scan [Cancel on page 413](#).
- **Length Within Range** - Select this option to decode a Matrix 2 of 5 symbol with a specific length range. Select lengths using the numeric barcodes in [Numeric Barcodes](#). For example, to decode Matrix 2 of 5 symbols containing between 4 and 12 characters, first scan Matrix 2 of 5 - Length Within Range. Then scan 0, 4, 1, and 2 (enter a leading zero for single digit numbers). To correct an error or change the selection, scan [Cancel on page 413](#).
- **Any Length** - Scan this option to decode Matrix 2 of 5 symbols containing any number of characters within the digital scanner's capability.



Matrix 2 of 5 - One Discrete Length



Matrix 2 of 5 - Two Discrete Lengths



Matrix 2 of 5 - Length Within Range



Matrix 2 of 5 - Any Length

Matrix 2 of 5 Check Digit

Parameter # 622 (SSI # F1h 6Eh)

The check digit is the last character of the symbol used to verify the integrity of the data. Scan the appropriate barcode below to transmit the barcode data with or without the Matrix 2 of 5 check digit.



**Enable Matrix 2 of 5 Check Digit
(1)**



*** Disable Matrix 2 of 5 Check Digit
(0)**

Transmit Matrix 2 of 5 Check Digit

Parameter # 623 (SSI # F1h 6Fh)

Scan a barcode below to transmit Matrix 2 of 5 data with or without the check digit.



**Transmit Matrix 2 of 5 Check Digit
(1)**



*** Do Not Transmit Matrix 2 of 5 Check Digit
(0)**

Korean 3 of 5

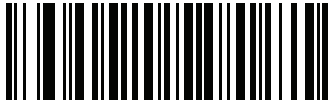
Enable/Disable Korean 3 of 5

Parameter # 581 (SSI # F1h 45h)

To enable or disable Korean 3 of 5, scan the appropriate barcode below.



NOTE: The length for Korean 3 of 5 is fixed at 6.



**Enable Korean 3 of 5
(1)**



*** Disable Korean 3 of 5
(0)**

Inverse 1D

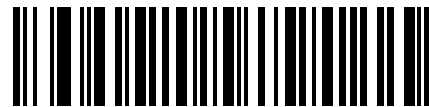
Parameter # 586 (SSI # F1h 4Ah)

This parameter sets the 1D inverse decoder setting. Options are:

- **Regular Only** - the digital scanner decodes regular 1D barcodes only.
- **Inverse Only** - the digital scanner decodes inverse 1D barcodes only.
- **Inverse Autodetect** - the digital scanner decodes both regular and inverse 1D barcodes.



* Regular
(0)



Inverse Only
(1)



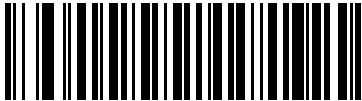
Inverse Autodetect
(2)

GS1 DataBar

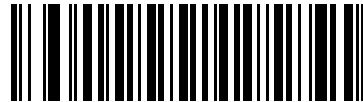
The variants of GS1 DataBar are DataBar-14, DataBar Expanded, and DataBar Limited. The limited and expanded versions have stacked variants. Scan the appropriate barcodes to enable or disable each variant of GS1 DataBar.

GS1 DataBar-14

Parameter # 338 (SSI # F0h 52h)



* Enable GS1 DataBar-14
(1)



Disable GS1 DataBar-14
(0)

GS1 DataBar Limited

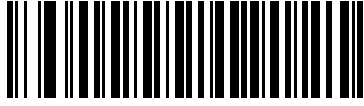
Parameter # 339 (SSI # F0h 53h)



* Enable GS1 DataBar Limited
(1)



Disable GS1 DataBar Limited
(0)

GS1 DataBar Expanded**Parameter # 340 (SSI # F0h 54h)**

*** Enable GS1 DataBar Expanded
(1)**

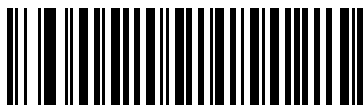


**Disable GS1 DataBar Expanded
(0)**

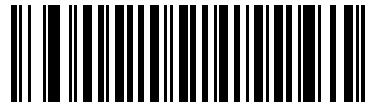
Convert GS1 DataBar to UPC/EAN**Parameter # 397 (SSI # F0h 8Dh)**

This parameter only applies to GS1 DataBar-14 and GS1 DataBar Limited symbols not decoded as part of a Composite symbol. Enable this to strip the leading '010' from DataBar-14 and DataBar Limited symbols encoding a single zero as the first digit, and report the barcode as EAN-13.

For barcodes beginning with two or more zeros but not six zeros, this parameter strips the leading '0100' and reports the barcode as UPC-A. The UPC-A Preamble parameter that transmits the system character and country code applies to converted barcodes. Note that neither the system character nor the check digit can be stripped.



**Enable Convert GS1 DataBar to UPC/EAN
(1)**



*** Disable Convert GS1 DataBar to UPC/EAN
(0)**

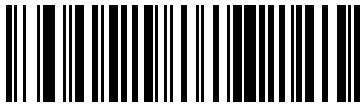
GS1 DataBar Security Level

Parameter # 1706 (SSI # F8h 06h AAh)

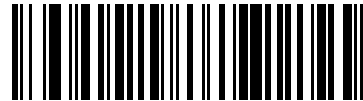
This parameter sets the security level for GS1 DataBar.

The scanner offers four levels of decode security for GS1 DataBar (GS1 DataBar Omnidirectional, GS1 DataBar Limited, GS1 DataBar Expanded) barcodes.

- Security Level 0 - The scanner operates in its most aggressive state, while providing sufficient security decoding most in-spec barcodes.
- *Security Level 1 - This setting eliminates most misdecodes while maintaining reasonable aggressiveness.
- Security Level 2 - Select this option with greater barcode security requirements if Security Level 1 fails to eliminate misdecodes.
- Security Level 3 - If you selected Security Level 2 and misdecodes still occur, select this security level to apply the highest safety requirements.



GS1 DataBar Security Level 0
(0)



***GS1 DataBar Security Level 1**
(1)



GS1 DataBar Security Level 2
(2)



GS1 DataBar Security Level 3
(3)

GS1 DataBar Limited Security Level

Parameter # 728 (SSI # F1h D8h)

The imager offers four levels of decode security for GS1 DataBar Limited barcodes. There is an inverse relationship between security and imager aggressiveness. Increasing the level of security may result in reduced aggressiveness in scanning, so choose only that level of security necessary.

- **Level 1** – No clear margin required. This complies with the original GS1 standard, yet might result in erroneous decoding of the DataBar Limited barcode when scanning some UPC symbols that start with digits “9” and “7”
- **Level 2** – Automatic risk detection. This level of security may result in erroneous decoding of DataBar Limited barcodes when scanning some UPC symbols. The imager defaults to Level 3, otherwise to Level 1.
- **Level 3** – Security level reflects newly proposed GS1 standard that requires a 5 times trailing clear margin.
- **Level 4** – Security level extends beyond the standard required by GS1. This level of security requires a 5 times leading and trailing clear margin.



GS1 DataBar Limited Security Level 1
(1)



GS1 DataBar Limited Security Level 2
(2)



* GS1 DataBar Limited Security Level 3
(3)



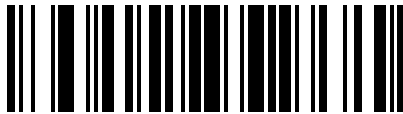
GS1 DataBar Limited Security Level 4
(4)

GS1 Digital Link Parameters

GS1 Digital Link

Parameter # 2373 (SSI #F8h 09h 45h)

Scan a bar code below to enable or disable GS1 Digital Link.



Enable
(1)



*Disable
(0)

GS1 Digital Link Mode

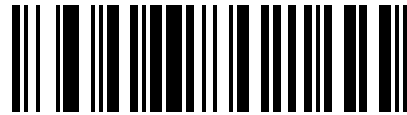
Parameter # 2374 (SSI #F8h 09h 46h)

This parameter selects the GS1 Digital Link Mode when the GS1 Digital Link is enabled.

- **Mode 1 - GTIN only:** This mode sends either the 1D GTIN or 2D GTIN, whichever is decoded first.
- **Mode 2 - Prioritize 2D:** This mode prioritizes the 2D GS1 Digital Link over 1D barcodes. If it sees the 2D within the GS1 Digital Link Timeout, it reports the 2D barcode only. If it does not decode a 2D GS1 Digital Link barcode within the GS1 Digital Link Timeout or the trigger is released, it will report the 1D barcode, assuming the 1D was in the field of view and decoded.
- **Mode 3 - Corroborate 1D and 2D GTINs Match:** The 1D barcode is reported if it is decoded before the 2D barcode. If a matching GTIN 2D barcode is seen within the GS1 Digital Link Timeout, the 2D is also reported. The matching 1D and 2D barcodes have the same unique 8-digit prefix to indicate they have the same data. If the 2D is decoded first before the 1D, only the 2D is reported.



*Mode 1 - GTIN only (1)



Mode 2 - Prioritize 2D



Mode 3 - Corroborate 1D and 2D GTINs Match

GS1 Digital Link Prioritization Timeout

Parameter # 2491 (SSI #F8h 09h BBh)

This parameter defines the maximum amount of time the scanner attempts to decode a 2D GS1 Digital Link barcode. The default value is 200 msec.

To set the GS1 Digital Link Timeout, scan the barcode below. Then, scan four numeric barcodes from the [Numeric Barcodes](#) corresponding to the desired prioritization time. Enter leading zeroes for times of less than 4 values. For example, to enter 250 msec, scan 0 2 5 0. To correct an error or change the selection, scan [Cancel](#).

- When the Digital Link Mode is set to **Mode 2**, this is the amount of time the scanner looks for the 2D GS1 Digital Link barcode. If the timer expires or the trigger is released before finding the 2D GS1 barcode, the 1D barcode is sent.
- When the Digital Link Mode is set to **Mode 3**, if the 1D barcode is decoded first, this is the amount of time the scanner continues to look for the 2D barcode.

NOTE This parameter is set in 1 msec increments.



GS1 Digital Link Prioritization Timeout

Composite

Composite CC-C

Parameter # 341 (SSI # F0h 55h)

Scan a barcode below to enable or disable Composite barcodes of type CC-C.



Enable CC-C
(1)

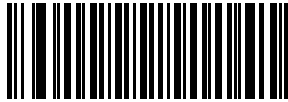


* Disable CC-C
(0)

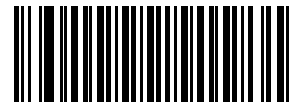
Composite CC-A/B

Parameter # 342 (SSI # F0h 56h)

Scan a barcode below to enable or disable Composite barcodes of type CC-A/B.



Enable CC-A/B
(1)

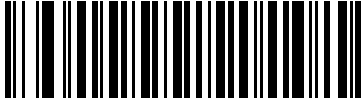


* Disable CC-A/B
(0)

Composite TLC-39

Parameter # 371 (SSI # F0h 73h)

Scan a barcode below to enable or disable Composite barcodes of type TLC-39.



Enable TLC39
(1)



* Disable TLC39
(0)

Composite Inverse

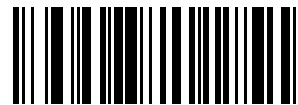
Parameter # 1113 (SSI #F8h 04h 59h)

This parameter sets Composite for either regular decode or inverse decode.

- *Regular Only - The scanner decodes regular Composite barcodes only. Before selecting this, set [Inverse 1D](#) to Regular Only or Inverse Autodetect.
- Inverse Only - The scanner decodes inverse Composite barcodes only. This mode only supports Composite Inverse that includes DataBar combined with CCAB, and does not support other 1D/2D combinations. Before selecting this, first enable [Composite CC-A/B](#), and set [Inverse 1D](#) to Inverse Only or Inverse Autodetect.



* Regular Only (0)



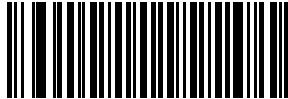
Inverse Only (1)

UPC Composite Mode

Parameter # 344 (SSI # F0h 58h)

Select an option for linking UPC symbols with a 2D symbol during transmission as if they were one symbol:

- Select **UPC Never Linked** to transmit UPC barcodes regardless of whether a 2D symbol is detected.
- Select **UPC Always Linked** to transmit UPC barcodes and the 2D portion. If 2D is not present, the UPC barcode does not transmit.
- If you select **Autodiscriminate UPC Composites**, the digital scanner determines if there is a 2D portion, then transmits the UPC, as well as the 2D portion if present.



* **UPC Never Linked**
(0)



UPC Always Linked
(1)

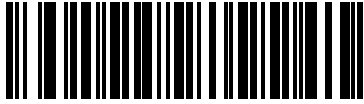


Autodiscriminate UPC Composites
(2)

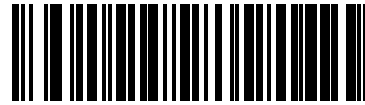
Composite Beep Mode

Parameter # 398 (SSI # F0h 8Eh)

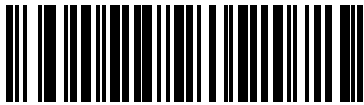
To select the number of decode beeps when a composite barcode is decoded, scan the appropriate barcode.



Single Beep after both are decoded
(0)



* Beep as each code type is decoded
(1)



Double Beep after both are decoded
(2)

GS1-128 Emulation Mode for UCC/EAN Composite Codes

Parameter # 427 (SSI # F0h ABh)

Select whether to enable or disable this mode.



Enable GS1-128 Emulation Mode for
UCC/EAN Composite Codes
(1)



* Disable GS1-128 Emulation Mode for
UCC/EAN Composite Codes
(0)

2D Symbologies

Enable/Disable PDF417

Parameter # 15 (SSI # 0Fh)

To enable or disable PDF417, scan the appropriate barcode below.



* Enable PDF417
(1)



Disable PDF417
(0)

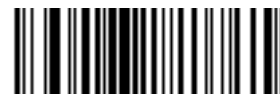
Enable/Disable MicroPDF417

Parameter # 227 (SSI # E3h)

To enable or disable MicroPDF417, scan the appropriate barcode below.



Enable MicroPDF417
(1)



* Disable MicroPDF417
(0)

Code 128 Emulation

Parameter # 123 (SSI # 7Bh)

Enable this parameter to transmit data from certain MicroPDF417 symbols as Code 128. [Transmit Code ID Character on page 80](#) must be enabled for this parameter to work.

Enable Code 128 Emulation to transmit these MicroPDF417 symbols with one of the following prefixes:

-]C1 if the first codeword is 903-905
-]C2 if the first codeword is 908 or 909
-]C0 if the first codeword is 910 or 911

Disable Code 128 Emulation to transmit these MicroPDF417 symbols with one of the following prefixes:

-]L3 if the first codeword is 903-905
-]L4 if the first codeword is 908 or 909
-]L5 if the first codeword is 910 or 911

Scan a barcode below to enable or disable Code 128 Emulation.



NOTE: Linked Micro PDF codewords 906, 907, 912, 914, and 915 are not supported. Use GS1 Composites instead.



Enable Code 128 Emulation
(1)

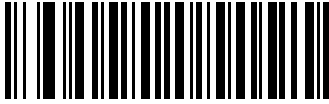


*** Disable Code 128 Emulation**
(0)

Data Matrix

Parameter # 292 (SSI # F0h 24h)

To enable or disable Data Matrix, scan the appropriate barcode below.



*** Enable Data Matrix
(1)**

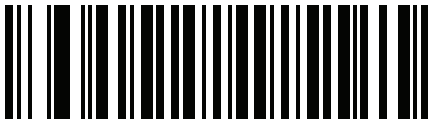


**Disable Data Matrix
(0)**

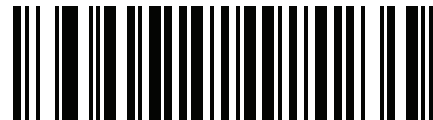
GS1 Data Matrix

Parameter # 1336 (SSI # F8h 05h 38h)

To enable or disable GS1 Data Matrix, scan the appropriate barcode below.



*** Disable GS1 Data Matrix
(0)**



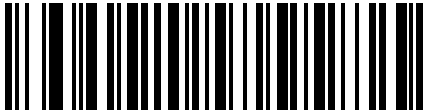
**Enable GS1 Data Matrix
(1)**

Data Matrix Inverse

Parameter # 588 (SSI # F1h 4Ch)

This parameter sets the Data Matrix inverse decoder setting. Options are:

- **Regular Only** - the imager decodes regular Data Matrix barcodes only.
- **Inverse Only** - the imager decodes inverse Data Matrix barcodes only.
- **Inverse Autodetect** - the imager decodes both regular and inverse Data Matrix barcodes.



Regular
(0)



Inverse Only
(1)

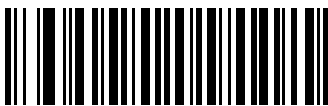


* Inverse Autodetect
(2)

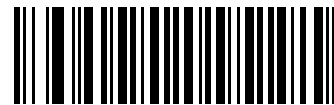
Maxicode

Parameter # 294 (SSI # F0h 26h)

To enable or disable Maxicode, scan the appropriate barcode below.



Enable Maxicode
(1)



* Disable Maxicode
(0)

QR Code

Parameter # 293 (SSI # F0h 25h)



NOTE: Inverse QR barcodes decode if QR Code is enabled.

To enable or disable QR Code, scan the appropriate barcode below.



* Enable QR Code
(1)



Disable QR Code
(0)

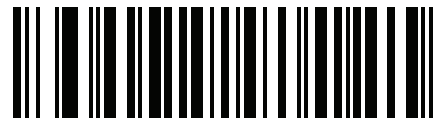
GS1 QR

Parameter # 1343 (SSI # F8h 05h 3Fh)

To enable or disable, scan the appropriate barcode below.



* Disable
(0)

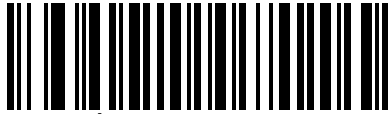


Enable
(1)

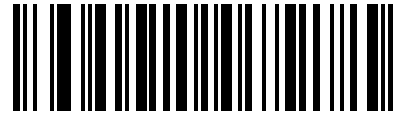
MicroQR

Parameter # 573 (SSI # F1h 3Dh)

To enable or disable MicroQR, scan the appropriate barcode below.



* Enable MicroQR
(1)



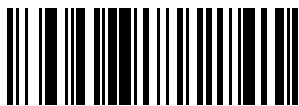
Disable MicroQR
(0)

Linked QR Mode

Parameter # 1847 (SSI # 737h)

This parameter selects a linked QR mode.

- *Linked QR Only - The scanner does not decode individual QR symbols from a set of linked QR codes.
- Individual QR With Headers - The scanner decodes individual QR symbols from a set of linked QR codes and retains the header information and data.
- Individual QR No Headers - The scanner decodes individual QR symbols from a set of linked QR codes and transmits the data without header information.



*Linked QR Only
(0)



Individual QR With Headers
(1)

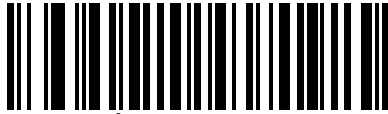


Individual QR No Headers
(2)

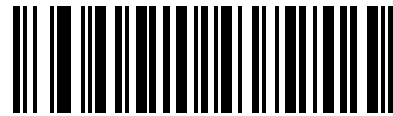
Aztec

Parameter # 574 (SSI # F1h 3Eh)

To enable or disable Aztec, scan the appropriate barcode below.



* Enable Aztec
(1)



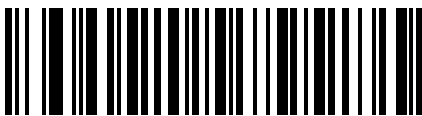
Disable Aztec
(0)

Aztec Inverse

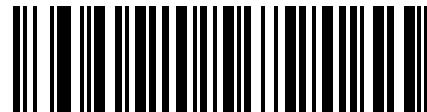
Parameter # 589 (SSI # F1h 4Dh)

This parameter sets the Aztec inverse decoder setting. Options are:

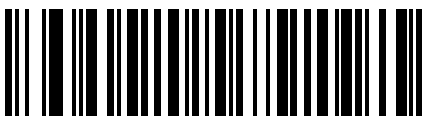
- **Regular Only** - the digital scanner decodes regular Aztec barcodes only.
- **Inverse Only** - the digital scanner decodes inverse Aztec barcodes only.
- **Inverse Autodetect** - the digital scanner decodes both regular and inverse Aztec barcodes.



Regular
(0)



Inverse Only
(1)



* Inverse Autodetect
(2)

Han Xin

Parameter # 1167 (SSI # F8h 04h 8Fh)

To enable or disable Han Xin, scan the appropriate barcode below.



Enable Han Xin
(1)



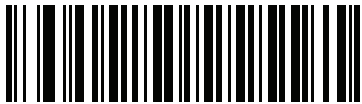
* Disable Han Xin
(0)

Han Xin Inverse

Parameter # 1168 (SSI # F8h 04h 90h)

Select a Han Xin inverse decoder setting:

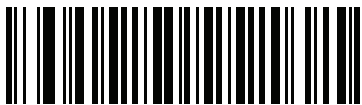
- **Regular Only** - the decoder decodes Han Xin barcodes with normal reflectance only.
- **Inverse Only** - the decoder decodes Han Xin barcodes with inverse reflectance only.
- **Inverse Autodetect** - the decoder decodes both regular and inverse Han Xin barcodes.



* Regular
(0)



Inverse Only
(1)



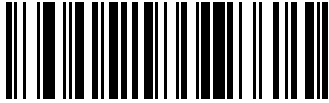
Inverse Autodetect
(2)

Grid Matrix

Parameter # 1718 (SSI #F8 06h B6h)

This parameter enables or disables Grid Matrix.

- Enabled - enables Grid Matrix.
- *Disabled - disables Grid Matrix.



Enable Grid Matrix (1)



* Disable Grid Matrix (0)

Grid Matrix Inverse

Parameter # 1719 (SSI #F8h 06h B7h)

This parameter selects a Grid Matrix inverse decoder setting.

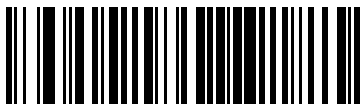
- *Regular Only - the imager decodes Grid Matrix barcodes with normal reflectance only.
- Inverse Only - the imager decodes Grid Matrix barcodes with inverse reflectance only.
- Inverse Autodetect - the imager decodes both regular and inverse Grid Matrix barcodes.



* Regular Only (0)



Inverse Only (1)



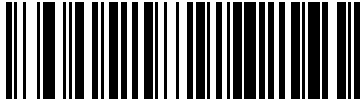
Inverse Autodetect (2)

Grid Matrix Mirrored

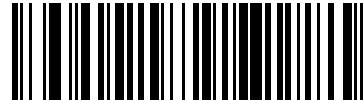
Parameter # 1736 (SSI #F8h 06h C8h)

This parameter selects a mirror image Grid Matrix setting.

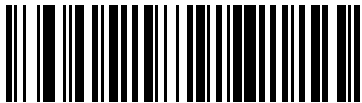
- ***Non-Mirrored Only** - the imager decodes non-mirrored Grid Matrix barcodes only.
- **Mirrored Only** - the imager decodes mirrored Grid Matrix barcodes only.
- **Mirrored Autodetect** - the imager decodes both mirrored and non-mirrored Grid Matrix barcodes.



*** Non-Mirrored Only**
(0)



Mirrored Only
(1)

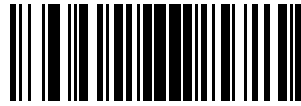


Mirrored Autodetect
(2)

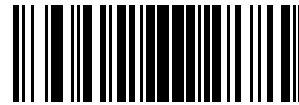
DotCode

Parameter # 1906 (SSI # F8 07 72h)

Scan one of the following barcodes to enable or disable DotCode.



* Disable DotCode
(0)



Enable DotCode
(1)

DotCode Inverse

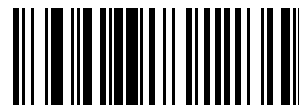
Parameter # 1907 (SSI # F8 07 73h)

Scan one of the following barcodes to select a DotCode Inverse decoder setting. Setting options are:

- **Regular Only** - Decoder decodes DotCode barcodes with normal reflectance only.
- **Inverse Only** - Decoder decodes DotCode barcodes with inverse reflectance only.
- **Autodetect** - Decoder decodes both regular and inverse DotCode barcodes.



Regular
(0)



Inverse Only
(1)



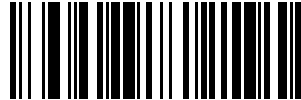
* Autodetect
(2)

DotCode Mirrored

Parameter # 1908 (SSI # F8 07 74h)

Scan one of the following barcodes to select a DotCode Mirror decoder setting:

- **Non-Mirrored Only** - Digital scanner decodes non-mirrored DotCode barcodes only.
- **Mirrored Only** - Digital scanner decodes mirrored DotCode barcodes only.
- **Autodetect** - Digital scanner decodes both mirrored and non-mirrored DotCode barcodes.



**Non-Mirrored Only
(0)**



**Mirrored Only
(1)**

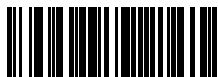


*** Autodetect
(2)**

DotCode Prioritize

Parameter # 1937 (SSI # F8 07 91h)

Enable DotCode Prioritize to give priority to DotCode decoding as compared to other symbologies.



*** Disable**



Enable

DotCode Erasure Limit

Parameter # 2063 (SSI # F8 08 0F)

This parameter sets the maximum number of erasures in DotCode codewords before passing the codewords for error correction. The value range is from 4 to 20. The default value is 10.

A bigger value means that DotCode barcodes are easier to decode, but the chance of getting a misdecode is higher.

To set a DotCode Erasure Limit value, scan the following barcode, and then scan two barcodes from [Numeric Barcodes on page 412](#) that correspond to the desired value. Enter a leading zero for single digit numbers. For example, to set an erasure value of 4, scan this barcode, and then scan the **0** and **4** barcodes. To correct an error or change the selection, scan [Cancel](#).



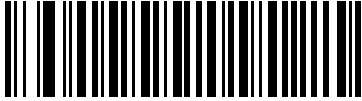
DotCode Erasure Limit

Postal Codes

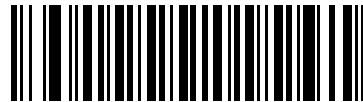
US Postnet

Parameter # 89 (SSI # 59h)

To enable or disable US Postnet, scan the appropriate barcode below.



**Enable US Postnet
(1)**



*** Disable US Postnet
(0)**

US Planet

Parameter # 90 (SSI # 5Ah)

To enable or disable US Planet, scan the appropriate barcode below.



**Enable US Planet
(1)**



*** Disable US Planet
(0)**

Transmit US Postal Check Digit

Parameter # 95 (SSI # 5Fh)

Select whether to transmit US Postal data, which includes both US Postnet and US Planet, with or without the check digit.



* Transmit US Postal Check Digit
(1)



Do Not Transmit US Postal Check Digit
(0)

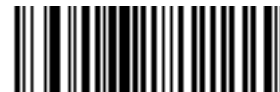
UK Postal

Parameter # 91 (SSI # 5Bh)

To enable or disable UK Postal, scan the appropriate barcode below.



Enable UK Postal
(1)



* Disable UK Postal
(0)

Transmit UK Postal Check Digit

Parameter # 96 (SSI # 60h)

Select whether to transmit UK Postal data with or without the check digit.



* Transmit UK Postal
Check Digit
(1)

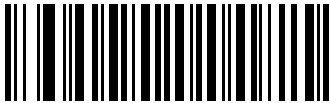


Do Not Transmit UK Postal Check Digit
(0)

Japan Postal

Parameter # 290 (SSI # F0h 22h)

To enable or disable Japan Postal, scan the appropriate barcode below.



Enable Japan Postal
(1)



* Disable Japan Postal
(0)

Australia Post

Parameter # 291 (SSI # F0h 23h)

To enable or disable Australia Post, scan the appropriate barcode below.



Enable Australia Post
(1)



*** Disable Australia Post**
(0)

Australia Post Format

Parameter # 718 (SSI # F1h CEh)

To select one of the following formats for Australia Post, scan the appropriate barcode below:

- **Autodiscriminate** (or Smart mode) - Attempt to decode the Customer Information Field using the N and C Encoding Tables.



NOTE: This option increases the risk of misdecodes because the encoded data format does not specify the Encoding Table used for encoding.

- **Raw Format** - Output raw bar patterns as a series of numbers 0 through 3.
- **Alphanumeric Encoding** - Decode the Customer Information Field using the C Encoding Table.
- **Numeric Encoding** - Decode the Customer Information Field using the N Encoding Table.

For more information on Australia Post Encoding Tables, refer to the *Australia Post Customer Barcoding Technical Specifications* available at auspost.com.au



* Autodiscriminate
(0)



Raw Format
(1)



Alphanumeric Encoding
(2)

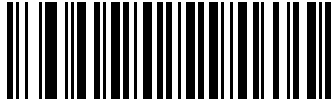


Numeric Encoding
(3)

Netherlands KIX Code

Parameter # 326 (SSI # F0h 46h)

To enable or disable Netherlands KIX Code, scan the appropriate barcode below.



Enable Netherlands KIX Code
(1)

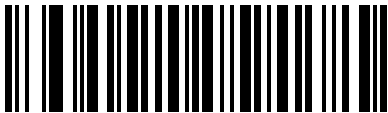


*** Disable Netherlands KIX Code**
(0)

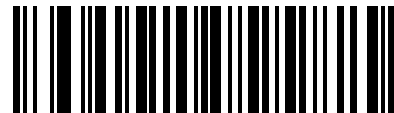
USPS 4CB/One Code/Intelligent Mail

Parameter # 592 (SSI # F1h 50h)

To enable or disable USPS 4CB/One Code/Intelligent Mail, scan the appropriate barcode below.



Enable USPS 4CB/One Code/Intelligent Mail
(1)



*** Disable USPS 4CB/One Code/Intelligent Mail**
(0)

UPU FICS Postal

Parameter # 611 (SSI # F1h 63h)

To enable or disable UPU FICS Postal, scan the appropriate barcode below.



**Enable UPU FICS Postal
(1)**

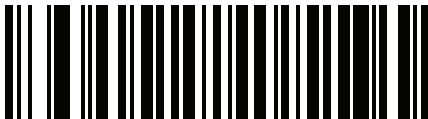


*** Disable UPU FICS Postal
(0)**

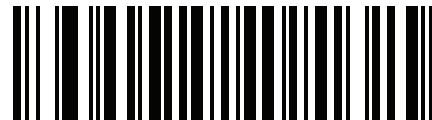
Mailmark

Parameter # 1337 (SSI # F8h 05h 39h)

To enable or disable Mailmark, scan the appropriate barcode below.



*** Disable Mailmark
(0)**



**Enable Mailmark
(1)**

Symbology-Specific Security Levels

Redundancy Level

Parameter # 78 (SSI # 4Eh)

The imager offers four levels of decode redundancy. Select higher redundancy levels for decreasing levels of barcode quality. As redundancy levels increase, the imager's aggressiveness decreases.

Select the redundancy level appropriate for the barcode quality.

Redundancy Level 1

The following code types must be successfully read twice before being decoded:

Table 20 Redundancy Level 1 Codes

Code Type	Code Length
Codabar	8 characters or less
MSI	4 characters or less
D 2 of 5	8 characters or less
I 2 of 5	8 characters or less

Redundancy Level 2

The following code types must be successfully read twice before being decoded:

Table 21 Redundancy Level 2 Codes

Code Type	Code Length
All	All

Redundancy Level 3

Code types other than the following must be successfully read twice before being decoded. The following codes must be read three times:

Table 22 Redundancy Level 3 Codes

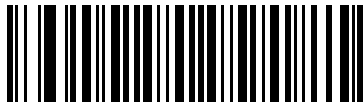
Code Type	Code Length
MSI	4 characters or less
D 2 of 5	8 characters or less
I 2 of 5	8 characters or less
Codabar	8 characters or less

Redundancy Level 4

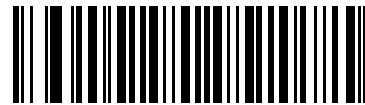
The following code types must be successfully read three times before being decoded:

Table 23 Redundancy Level 4 Codes

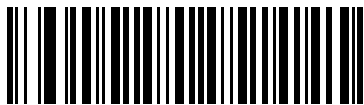
Code Type	Code Length
All	All



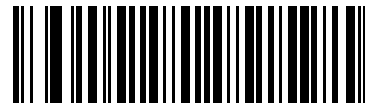
* Redundancy Level 1
(1)



Redundancy Level 2
(2)



Redundancy Level 3
(3)



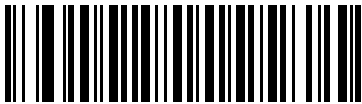
Redundancy Level 4
(4)

Security Level

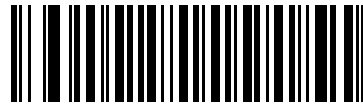
Parameter # 77 (SSI # 4Dh)

The imager offers four levels of decode security for delta barcodes, which include the Code 128 family, UPC/EAN, and Code 93. Select increasing levels of security for decreasing levels of barcode quality. There is an inverse relationship between security and imager aggressiveness, so choose only that level of security necessary for any given application.

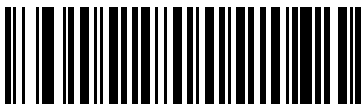
- **Security Level 0:** This setting allows the imager to operate in its most aggressive state, while providing sufficient security in decoding most “in-spec” barcodes.
- **Security Level 1:** This default setting eliminates most misdecodes.
- **Security Level 2:** Select this option if Security level 1 fails to eliminate misdecodes.
- **Security Level 3:** If you selected Security Level 2 and misdecodes still occur, select this security level. Be advised, selecting this option is an extreme measure against mis-decoding severely out of spec barcodes. Selecting this level of security significantly impairs the decoding ability of the digital scanner. If you need this level of security, try to improve the quality of the barcodes.



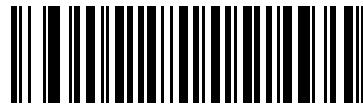
Security Level 0
(0)



* Security Level 1
(1)



Security Level 2
(2)



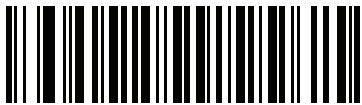
Security Level 3
(3)

1D Quiet Zone Level

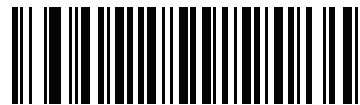
Parameter # 1288 (SSI # F8h 05h 08h)

This feature sets the level of aggressiveness in decoding barcodes with a reduced quiet zone (the area in front of and at the end of a barcode), and applies to symbologies enabled by a Reduced Quiet Zone parameter. Because higher levels increase the decoding time and risk of misdecodes, Symbol Technologies strongly recommends enabling only the symbologies which require higher quiet zone levels, and leaving Reduced Quiet Zone disabled for all other symbologies. Options are:

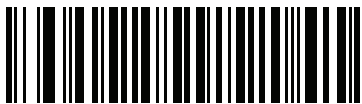
- 0 - The imager performs normally in terms of quiet zone.
- 1 - The imager performs more aggressively in terms of quiet zone.
- 2 - The imager only requires one side EB (end of barcode) for decoding.
- 3 - The imager decodes anything in terms of quiet zone or end of barcode.



1D Quiet Zone Level 0
(0)



* 1D Quiet Zone Level 1
(1)



1D Quiet Zone Level 2
(2)

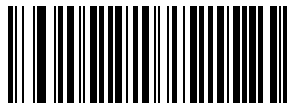


1D Quiet Zone Level 3
(3)

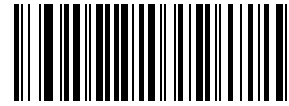
Intercharacter Gap Size

Parameter # 381 (SSI # F0h 7Dh)

The Code 39 and Codabar symbologies have an intercharacter gap that is typically quite small. Due to various barcode-printing technologies, this gap can grow larger than the maximum size allowed, preventing the imager from decoding the symbol. If this problem occurs, scan the **Large Intercharacter Gaps** parameter to tolerate these out-of-specification barcodes.



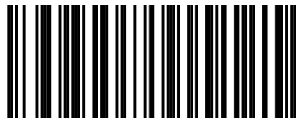
* Normal Intercharacter Gaps
(6)



Large Intercharacter Gaps
(10)

Report Version

Scan the barcode below to report the version of software installed in the imager.



Report Software Version

Macro PDF Features

Macro PDF is a special feature for concatenating multiple PDF symbols into one file. The imager can decode symbols that are encoded with this feature, and can store more than 64 Kb of decoded data stored in up to 50 Macro PDF symbols.



CAUTION When printing, keep each Macro PDF sequence separate, as each sequence has unique identifiers. Do not mix barcodes from several Macro PDF sequences, even if they encode the same data. When scanning Macro PDF sequences, scan the entire Macro PDF sequence without interruption. If, when scanning a mixed sequence, the imager emits two long low beeps (Low/Low) this indicates an inconsistent file ID or inconsistent symbology error.

Flush Macro Buffer

This flushes the buffer of all decoded Macro PDF data stored to that point, transmits it to the host device, and aborts from Macro PDF mode.



Flush Macro PDF Buffer

Abort Macro PDF Entry

This clears all currently-stored Macro PDF data in the buffer without transmission and aborts from Macro PDF mode.



Abort Macro PDF Entry

Digimarc

Introduction

Digimarc Barcode is an invisible machine-readable code.

Digimarc Parameter Defaults

The following table lists the defaults for Digimarc parameters.

Scan the appropriate barcode to enable or disable the Digimarc Digital Watermarks code.

Change these values in one of two ways:

- Scan the appropriate options in this section. The new value replaces the standard default value in memory. To recall default parameter values, see [Default Parameters](#).
- Configure the scanner using the 123Scan configuration program. See [123Scan](#)

Table 24 Digimarc Parameter Defaults

Parameter	Parameter Number	SSI Number	Default	Page Number
Digimarc Digital Watermarks	1687	F8h 06h 97h	Disabled	251
Digimarc Data Mode	2257	F8h 09h B8h	Compatible	252
Digimarc GIA17 Format	2488	F8h 09h 6Ch	Enabled	253

Digimarc Symbology

Digimarc codes are reported as UPC-A, UPC-E, EAN-13, or GS1 DataBar Expanded.

✓ **NOTE** Converting the Digimarc reported code types to other barcode types is not supported.

AIM and Symbol code IDs are supported for the reported Digimarc code types.

Picklist

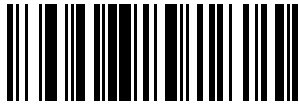
The Digimarc decoder searches configured block areas of the image for Digimarc codes, and operates the same regardless of whether [Picklist Mode](#) is enabled or disabled.

✓ **NOTE** Decode time can be greater in [Picklist Mode](#) due to the additional processing required by the system and decoder.

Digimarc Digital Watermarks

Parameter # 1687 (SSI # F8h 06h 97h)

Scan the appropriate barcode to enable or disable the Digimarc Digital Watermarks code.



**Enable Digimarc Digital Watermarks
(1)**



***Disable Digimarc Digital Watermarks
(0)**

Digimarc Data Mode

Parameter #2257 (SSI #F8h 08h D1h)

This parameter selects the output format and type of Digimarc barcode.

Possible Digimarc barcode formats are:

- 1 - *Compatible
- 2 - Enhanced
- 3 - Native



***Compatible(1)**



Enhanced (2)



Native (3)

Digimarc GIA17 Format

Parameter # 2488 (SSI #F8h 09h B8h)

This parameter enables or disables Digimarc GIA17 format. Digimarc must be enabled for this parameter to apply.



*Enabled(1)



Disabled(0)

Data Formatting

Introduction

This chapter briefly describes the Zebra features available for customizing scanner operation.

Advanced Data Formatting (ADF)

Advanced Data Formatting (ADF) allows customizing data before transmission to the host device. Use ADF to edit scanned data to suit the host application's requirements. With ADF you scan one barcode per trigger pull. ADF is programmed using 123Scan.

For a video on Creating an Advanced Data Formatting (ADF) Rule using 123Scan, go to: zebra.com/ScannerHowToVideos

For additional information, refer to the Advanced Data Formatting Programmer Guide.

Multicode Data Formatting

Multicode Data Formatting (MDF) enables a 2D scanner to scan all barcodes on a label by presenting all barcodes to the scanner, and then modify and transmit the data to meet host application requirements. MDF supports programming up to nine unique labels into one scanner. MDF also supports scanning multiple barcodes on opposite sides of a box by holding the trigger.

Programming options include:

- Output all or specific barcodes
- Control the barcode output sequence
- Apply unique multicode data formatting (MDF) to each output barcode
- Discard scanned data if all required barcodes are not present

For more information, refer to the *MDF and Preferred Symbol User Guide*.

To watch a video on Creating an Multicode Data Formatting (MDF) Rule using 123Scan, go to: zebra.com/ScannerHowToVideos

MDF in Hands-Free Mode

MDF in a hands-free scanning mode may yield multiple unexpected and undesired outputs when a label (most likely on a complex label) passes through the scanner's field of view. This problem happens when the complex label's barcodes can be matched by more than one group (for example, Group 1 represents all barcodes present and Group 2 represent some barcodes present).

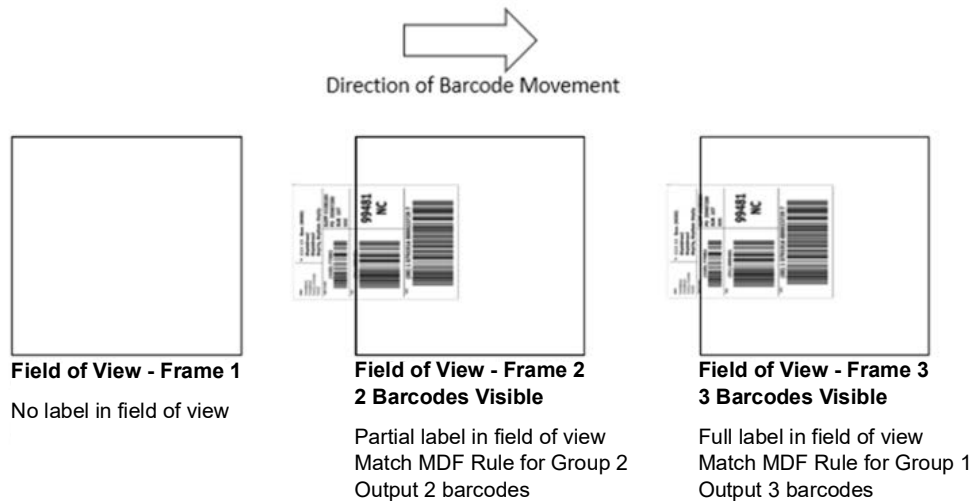


NOTE: A similar problem can also occur in the hand-held trigger mode. If multiple MDF rules/groups exist and all the label is not in the field of view when pressing the trigger, the output may vary depending on which MDF rules/groups match.

The problem is demonstrated in [Figure 25](#) and as follows:

1. As the label is moving through the field of view, it is first partially read (some of the barcodes in the field of view in Frame 2).
2. Then, the second decode occurs as it is fully read (all the barcodes in the field of view in Frame 3).
3. This yields two different outputs (instead of the expected single output) from the presentation of a label. This problem is driven by a complex label inadvertently matching two different MDF rules/groups, thereby yielding two outputs.

Figure 25 Scanning Label in a Horizontal Orientation



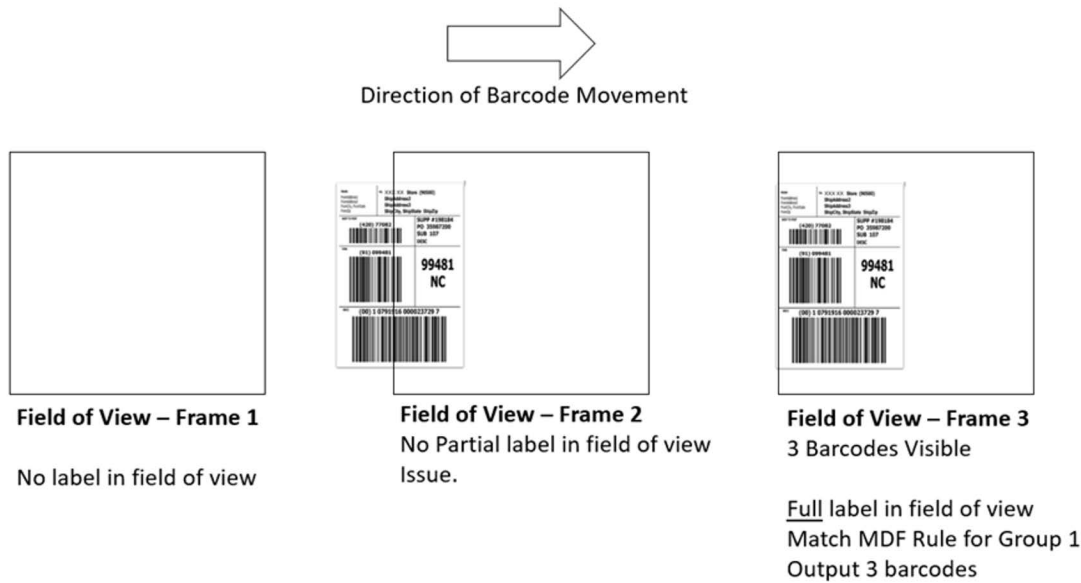
NOTE: To minimize issues associated with MDF hands-free mode, see [MDF Best Practices on page 256](#).

MDF Best Practices

Suggestions to minimize the undesired multiple outputs during the MDF scanning in hands-free mode are as follows:

- Scan barcodes in a vertical orientation (see [Figure 26](#)).

Figure 26 Scanning Label in a Vertical Orientation



- When creating the MDF programming with multiple groups, the Group 1's pattern match should be the most complicated (hardest to match), which equals to the most number of barcodes and criteria. Then Group 2, 3, and so on should be progressively matched more easily.
- When defining criteria, avoid enabling an output when the pattern is not matched. Set **Output if NO pattern match set** as **Discard bar code** (see [Figure 27](#)).

Figure 27 Figure Match Setting for Output

Pattern Match

A pattern match is the criteria used to determine if a set of scanned bar codes qualify for manipulation with Multicode Data Formatting.
If the pattern match criteria are met, the MDF will be applied to the output of "Output if pattern match".
If the pattern match criteria are not met, the MDF will be applied to the output of "Output if NO pattern match".

Is bar code required for pattern match [What is this?](#)

Required for match
 Not part of match

Output if pattern match.

Transmit bar code [What is this?](#)

Output if NO pattern match.

Discard bar code [What is this?](#)

Discard bar code

- Select **Discard barcode(s) NOT within the pattern match** in the 123Scan MDF setting. For more details, select **What is this?** located next to this selection.
 Discard scanned bar code(s) NOT within pattern match [What is this?](#)
- To prevent double decodes of the same symbol, increase the **Timeout Between Same Symbols** setting. See [Timeout Between Decodes, Same Symbol on page 71](#) for more details.
- Turn the scanner's aimer on to assist operators in scanning the barcode in a more consistent manner.

Other reasons a label/barcode may not be decoded while in the field of view are as follows:

- The label out of focus (too close or too far away). See [MS4717 Decode Zones on page 52](#) for correct working range.
- Specular reflection (reflection off a shiny surface).
- The label is presented at extreme angle to scanner.

Preferred Symbol

Preferred Symbol is a barcode prioritization technique that enables favored decoding of high priority barcode(s). The Preferred Symbol is the only barcode that is decoded and output within the preset Preferred Symbol Timeout. During this time, the scanner attempts to decode the prioritized barcode and reports only this barcode.

For more information, refer to the Multicode Data Formatting and Preferred Symbol User Guide, p/n MN-002895-xx.

To program Preferred Symbol via 123Scan, select 123Scan > Configuration Wizard > Symbologies screen, and then select Preferred Symbol from the drop-down menu. Preferred Symbol programming is saved in the 123Scan configuration file.

Data Parsing (UDI Scan+, Label Parse+ and Blood Bag Parse+)

Data Parsing allows a Zebra scanner to scan a UDI label, GS1 label, or Blood Bags with one or more barcodes encoded with multiple data fields (such as date of manufacture, expiration date, batch number, GTIN, and SSCC) and transmit select data fields and not others, in a specific order to a host application. Simply wave the scanner over all the barcodes while holding the trigger and the scanner takes care of the rest.

The scanner finds and transmits only the required data fields, even if they are spread across multiple barcodes and on different sides of the container. In addition, the scanner can insert field separators (such as tab, enter, and slash) to automate data entry into a host application.

Programming your scanner is easy using 123Scan's intuitive drag and drop interface. For more information on writing a Data Parsing Rule, refer to the Data Parsing (UDI, GS1 Label, Blood Bag) on Zebra Scanners User Guide available at: zebra.com/support

To watch a video on Creating a Data Parsing Rule using 123Scan, go to: zebra.com/ScannerHowToVideos

Scan a UDI Label using UDI Scan+

Government regulatory agencies¹ establish Unique Device Identification (UDI) standards to identify and monitor the distribution and use of medical devices within healthcare environments. These UDI standards identify medical devices from manufacturing through distribution to patient use - enabling complete traceability of the millions of individual medical devices utilized for patient care. To enable UDI compliance, all medical devices must carry a

UDI label to enable “track and trace” from the point of production, during shipment, through the product’s use and disposal.



NOTE: ¹ United States Food and Drug Administration (FDA), European Commission, International Medical Device Regulatory Forum.

Scan a GS1 Label using Label Parse+

The GS1 Organization, an international standards body, has released specifications used worldwide for generating shipping labels. These labels are used when shipping packages (logistics), raw materials and produce.

Scan a Blood Bag Label using Blood Bag Parse+

The ICCBBA Organization, an international standards body, has released a specification used worldwide for generating blood bag labels. These labels are used when shipping, storing and using blood bags. For more information, go to: icbba.org/tech-library/icbba-documents/standards-documents/standard-labeling-blood2.

Scan a Gs1 Retail POS Label using GS1 Digital Link Parsing

The GS1 Organization, an international standards body, has released specifications used worldwide for utilizing 2D barcodes at retail point-of-sale (POS) encoded with either Digital Link URI syntax or GS1 element string syntax. 2D retail barcodes may be used together on products with UPC/EAN barcodes.

OCR Programming

Introduction

This chapter describes how to set up the digital scanner for OCR programming. The digital scanner can read 6 to 60 point OCR typeface. It supports font types OCR-A, OCR-B, MICR-E13B, and US Currency Serial Number.

OCR is not as secure as a barcode. To decrease OCR misdecodes and speed OCR reading, set an accurate OCR template and character subset, and use a check digit.

All OCR fonts are disabled by default. Enabling OCR can slow barcode decoding. Enabling more than one OCR font could also slow OCR decoding and impact OCR decoding accuracy.

Throughout the programming barcode menus, asterisks (*) indicate default values. OCR Parameter Defaults



* Indicates Default — * **Disable OCR-A** — Feature/Option



NOTE: Most computer monitors allow scanning the barcodes directly on the screen. When scanning from the screen, be sure to set the document magnification to a level where you can see the barcode clearly, and bars and/or spaces are not merging.

Table 25 lists the defaults for OCR parameters. To change any option, scan the appropriate barcode(s) provided in the Parameter Descriptions section beginning on [page 261](#).



NOTE: See [Standard Default Parameters](#) for all user preferences, hosts, symbologies, and default parameters.

Table 25 OCR Programming Default Table

Parameter	Parameter Number	SSI Number	Default	Page Number
OCR Programming Parameters				
OCR-A	680	F1h A8h	Disable	261
OCR-A Variant	684	F1h ACh	Full ASCII	261
OCR-B	681	F1h A9h	Disable	263
OCR-B Variant	685	F1h ADh	Full ASCII	264

Table 25 OCR Programming Default Table (Continued)

Parameter	Parameter Number	SSI Number	Default	Page Number
MICR E13B	682	F1h AAh	Disable	267
US Currency	683	F1h ABh	Disable	268
OCR Orientation	687	F1h AFh	0°	268
OCR Lines	691	F1h B3h	1	270
OCR Minimum Characters	689	F1h B1h	3	270
OCR Maximum Characters	690	F1h B2h	100	271
OCR Subset	686	F1h AEh	Selected font variant	271
OCR Quiet Zone	695	F1h B7h	50	272
OCR Template	547	F1h 23h	99999999	273
OCR Check Digit Modulus	688	F1h B0h	1	283
OCR Check Digit Multiplier	700	F1h BCh	1212121212	284
OCR Check Digit Validation	694	F1h B6h	None	285
Inverse OCR	856	F2h 58h	Regular	290
OCR Redundancy	1770	F8h 06h EAh	Level 1	291

OCR Programming Parameters

Enable/Disable OCR-A

Parameter # 680 (SSI # F1h A8h)

To enable or disable OCR-A, scan one of the following barcodes.



NOTE: OCR is not as secure as a barcode. To decrease OCR misdecodes and speed OCR reading, set an accurate OCR template and character subset, and use a check digit. See [OCR Subset on page 271](#) and [OCR Template on page 273](#).



NOTE: All OCR fonts are disabled by default. Enabling OCR can slow barcode decoding. Enabling more than one OCR font could also slow OCR decoding and impact OCR decoding accuracy.



**Enable OCR-A
(1)**



*** Disable OCR-A
(0)**

OCR-A Variant

Parameter # 684 (SSI # F1 ACh)

Font variant sets a processing algorithm and default character subset for the given font. To choose a variant, scan one of the following barcodes. Selecting the most appropriate font variant optimizes performance and accuracy.

OCR-A supports the following variants:

- OCR-A Full ASCII
!"#\$()*+,-./0123456789<>ABCDEFGHIJKLMNOPQRSTUVWXYZ^
- OCR-A Reserved 1
\$*+,-./0123456789ABCDEFGHIJKLMNOPQRSTUVWXYZ
- OCR-A Reserved 2
\$*+,-./0123456789<>ABCDEFGHIJKLMNOPQRSTUVWXYZ
- OCR-A Banking
-0123456789<> ¥ ¢ ¤

OCR-A Variant (continued)

Special banking characters output as the following representative characters:

⌘ outputs as f

⌘ outputs as c

⌘ outputs as h



NOTE: Enable OCR-A before setting this parameter. If disabling OCR-A, set the variant to its default (OCR-A Full ASCII).



* OCR-A Full ASCII
(0)



OCR-A Reserved 1
(1)



OCR-A Reserved 2
(2)



OCR-A Banking
(3)

Enable/Disable OCR-B

Parameter # 681 (SSI # F1h A9h)

To enable or disable OCR-B, scan one of the following barcodes.



NOTE: OCR is not as secure as a barcode. To decrease OCR misdecodes and speed OCR reading, set an accurate OCR template and character subset, and use a check digit. See [OCR Subset on page 271](#) and [OCR Template on page 273](#).



NOTE: All OCR fonts are disabled by default. Enabling OCR can slow barcode decoding. Enabling more than one OCR font could also slow OCR decoding and impact OCR decoding accuracy.



**Enable OCR-B
(1)**



*** Disable OCR-B
(0)**

OCR-B Variant**Parameter # 685 (SSI # F1h ADh)**

OCR-B has the following variants. Selecting the most appropriate font variant affects performance and accuracy.

- OCR-B Full ASCII
!#\$%()*+,-./0123456789<>ABCDEFGHIJKLMNOPQRSTUVWXYZ^|ñ
- OCR-B Banking
#+-0123456789<>JNP|
- OCR-B Limited
+,-./0123456789<>ACENPSTVX
- OCR-B ISBN 10-Digit Book Numbers
-0123456789>BCEINPSXz
- OCR-B ISBN 10 or 13-Digit Book Numbers
-0123456789>BCEINPSXz
- OCR-B Travel Document Version 1 (TD1) 3-Line ID Cards
-0123456789<ABCDEFGHIJKLMNOPQRSTUVWXYZ
- OCR-B Travel Document Version 2 (TD2) 2-Line ID Cards
-0123456789<ABCDEFGHIJKLMNOPQRSTUVWXYZ
- OCR-B Travel Document 2 or 3-Line ID Cards Auto-Detect
!#\$%()*+,-./0123456789<>ABCDEFGHIJKLMNOPQRSTUVWXYZ^|ñ
- OCR-B Passport
-0123456789<ABCDEFGHIJKLMNOPQRSTUVWXYZñ
- OCR-B Visa Type A
-0123456789<ABCDEFGHIJKLMNOPQRSTUVWXYZ
- OCR-B Visa Type B
-0123456789<ABCDEFGHIJKLMNOPQRSTUVWXYZñ
- OCR-B ICAO Travel Documents
This allows reading either TD1, TD2, Passport, Visa Type A, or Visa Type B without switching between these options. It automatically recognizes the travel document read.

To choose a variant, scan one of the following barcodes. Selecting the following OCR-B variants automatically sets the appropriate [OCR Lines on page 270](#). These five variants invoke extensive special algorithms and checking for that particular document type:

Variant	OCR Lines Setting
Passport	2
TD1 ID Cards	3
TD2 ID Cards	2
Visa Type A	2
Visa Type B	2

Selecting one of the ISBN Book Numbers automatically applies the appropriate ISBN checksum, so you do not need to set this.

OCR-B Variant (continued)

For the best performance in passport reading, fix the target passport and the decoder in place (6.5 - 7.5”).



NOTE: Enable OCR-B before setting this parameter. If disabling OCR-B, set the variant to its default (OCR-B Full ASCII).



*** OCR-B Full ASCII
(0)**



**OCR-B Banking
(1)**



**OCR-B Limited
(2)**



**OCR-B ISBN 10-Digit Book Numbers
(6)**



**OCR-B ISBN 10 or 13-Digit Book Numbers
(7)**



**OCR-B Travel Document Version 1 (TD1)
3 Line ID Cards
(3)**

OCR-B Variant (continued)



**OCR-B Travel Document Version 2 (TD2)
2-Line ID Cards
(8)**



**Travel Document 2 or 3-Line ID Cards Auto-Detect
(20)**



**OCR-B Passport
(4)**



**OCR-B Visa Type A
(9)**



**OCR-B Visa Type B
(10)**



**OCR-B ICAO Travel Documents
(11)**

Enable/Disable MICR E13B

Parameter # 682 (SSI # F1h AAh)

To enable or disable MICR E13B, scan one of the following barcodes.

MICR E13B uses the following characters:

0 1 2 3 4 5 6 7 8 9 t a o d

TOAD characters (Transit, On Us, Amount, and Dash) output as the following representative characters:

t outputs as t

a outputs as a

o outputs as o

d outputs as d



NOTE: OCR is not as secure as a barcode. To decrease OCR misdecodes and speed OCR reading, set an accurate OCR template and character subset, and use a check digit. See [OCR Subset on page 271](#) and [OCR Template on page 273](#).



NOTE: All OCR fonts are disabled by default. Enabling OCR can slow barcode decoding. Enabling more than one OCR font could also slow OCR decoding and impact OCR decoding accuracy.



**Enable MICR E13B
(1)**



*** Disable MICR E13B
(0)**

Enable/Disable US Currency Serial Number

Parameter # 683 (SSI # F1h ABh)

To enable or disable US Currency Serial Number, scan one of the following barcodes.



NOTE: OCR is not as secure as a barcode. To decrease OCR misdecodes and speed OCR reading, set an accurate OCR template and character subset, and use a check digit. See [OCR Subset on page 271](#) and [OCR Template on page 273](#).



NOTE: All OCR fonts are disabled by default. Enabling OCR can slow barcode decoding. Enabling more than one OCR font could also slow OCR decoding and impact OCR decoding accuracy.



**Enable US Currency
(1)**



*** Disable US Currency
(0)**

OCR Orientation

Parameter # 687 (SSI # F1h AFh)

Select one of five options to specify the orientation of an OCR string to be read:

- 0° to the imaging engine (default)
- 270° clockwise (or 90° counterclockwise) to the imaging engine
- 180° (upside down) to the imaging engine
- 90° clockwise to the imaging engine
- Omnidirectional

Setting an incorrect orientation can cause misdecodes.

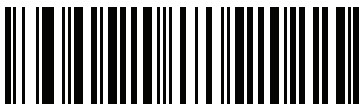
OCR Orientation (continued)



* OCR Orientation 0°
(0)



OCR Orientation 270° Clockwise
(1)



OCR Orientation 180° Clockwise
(2)



OCR Orientation 90° Clockwise
(3)



OCR Orientation Omnidirectional
(4)

OCR Lines

Parameter # 691 (SSI # F1h B3h)

To select the number of OCR lines to decode, scan one of the following barcodes. Selecting Visas, TD1, or TD2 ID cards automatically sets the appropriate **OCR Lines**. Also see [OCR-B Variant on page 264](#).



* OCR 1 Line
(1)



OCR 2 Lines
(2)



OCR 3 Lines
(3)

OCR Minimum Characters

Parameter # 689 (SSI # F1h B1h)

To select the minimum number of OCR characters (not including spaces) per line to decode, scan the following barcode, then scan a three-digit number between 003 and 100 using the barcodes in [Numeric Barcodes](#) representing the number of OCR characters to decode. Strings of OCR characters less than the minimum are ignored. The default is 003.



OCR Minimum Characters

OCR Maximum Characters

Parameter # 690 (SSI # F1h B2h)

To select the maximum number of OCR characters (including spaces) per line to decode, scan the following barcode, then scan a three-digit number between 003 and 100 using the barcodes in [Numeric Barcodes](#) representing the number of OCR characters to decode. Strings of OCR characters greater than the maximum are ignored. The default is 100.



OCR Maximum Characters

OCR Subset

Parameter # 686 (SSI # F1h AEh)

Set an OCR subset to define a custom group of characters in place of a preset font variant. For example, if scanning only numbers and the letters A, B, and C, create a subset of just these characters to speed decoding. This applies a designated OCR Subset across all enabled OCR fonts.

To set or modify the OCR font subset, first enable the appropriate OCR font(s). Next, scan the following barcode, then scan numbers and letters to form the OCR Subset from the alphanumeric keyboard in the *Advanced Data Formatting Guide*. Then scan **End of Message** in the *Advanced Data Formatting Guide*.



OCR Subset

To cancel an OCR subset, for OCR-A or OCR-B, scan OCR-A variant **Full ASCII**, or OCR-B variant **Full ASCII**.

For MICR E13B or US Currency Serial Number, create a subset which includes all allowed characters in that character set, or scan an option from the [Default Parameters on page 59](#) and re-program the digital scanner.

OCR Quiet Zone

Parameter # 695 (SSI # F1h B7h)

This option sets the OCR quiet zone. The digital scanner stops scanning a field when it detects a sufficiently wide blank space. The width of this space is defined by the End of Field option. Used with parsers that tolerate slanted characters, the End of Field count is roughly a count of 8 for a character width. For example if set to 15, then two character widths are an end of line indicator for the parser. Larger end of field numbers require bigger quiet zones at each end of text line.

To set a quiet zone, scan the following barcode, then scan a two-digit number using the numeric keypad in the *Advanced Data Formatting Guide*. The range of the quiet zone is 20 - 99 and the default is 50, indicating a six character width quiet zone.



OCR Quiet Zone

OCR Template

Parameter # 547 (SSI # F1h 23h)

This parameter creates a template for precisely matching scanned OCR characters to a desired input format.

Carefully constructing an OCR template eliminates scanning errors.

To set or modify the OCR decode template, scan the [OCR Template](#) barcode, then scan barcodes on the following pages that correspond to numbers and letters to form the template expression. Finally, scan **End of Message**. The default is **99999999** which accepts 8 numeric characters OCR strings.



OCR Template



End of Message

Required Digit (9)



9

Only a numeric character is allowed in this position.

Template	Valid data	Valid data	Invalid data
99999	12987	30517	123AB

Required Alpha (A)



A

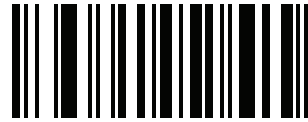
Only an alpha character is allowed in this position.

Template	Valid data	Valid data	Invalid data
AAA	ABC	WXY	12F

Require and Suppress (0)

It is required that any character in this position, including space or reject, is suppressed from the output.

Template	Incoming data	Output
990AA	12QAB	12AB



0

Optional Alphanumeric (1)



1

When this option appears in the template string, the data validator accepts an alphanumeric character if present. Optional characters are not allowed as the first character(s) in a field of like characters.

Template	Valid data	Valid data	Invalid data
99991	1234A	12345	1234<

Optional Alpha (2)



2

When this option appears in the template string, the data validator accepts an alpha character if present. Optional characters are not allowed as the first character(s) in a field of like characters.

Template	Valid data	Valid data	Invalid data
AAAA2	ABCDE	WXYZ	ABCD6

Alpha or Digit (3)**3**

The data validator requires an alphanumeric character in this position to validate the incoming data.

Template	Valid data	Valid data	Invalid data
33333	12ABC	WXY34	12AB<

Any Including Space & Reject (4)**4**

The template accepts any character in this position, including space and reject. Rejects are represented as an underscore (_) in the output. This is a good selection for troubleshooting.

Template	Valid data	Valid data
99499	12\$34	34_98

Any except Space & Reject (5)

5

The template accepts any character in this position except a space or reject.

Template	Valid data	Valid data	Invalid data
55999	A.123	*Z456	A BCD

Optional Digit (7)

7

When this option appears in the template string, the template accepts a numeric character if present. Optional characters are not allowed as the first character(s) in a field of like characters.

Template	Valid data	Valid data	Invalid data
99977	12345	789	789AB

Digit or Fill (8)**8**

The data validator accepts any numeric or fill character in this position.

Template	Valid data	Valid data	Valid data
88899	12345	>>789	<<789

Alpha or Fill (F)**F**

The data validator accepts any alpha or fill character in this position.

Template	Valid data	Valid data	Valid data
AAAFF	ABCXY	LMN>>	ABC<5

Optional Space ()**Space**

When this option appears in the template string, the template accepts a space if present. Optional characters are not allowed as the first character(s) in a field of like characters.

Template	Valid data	Valid data	Invalid data
99 99	12 34	1234	67891

Optional Small Special (.)



.

When this option appears in the template string, the data validator accepts a special character if present. Optional characters are not allowed as the first character(s) in a field of like characters. Small special characters are - , and .

Template	Valid data	Valid data	Invalid data
AA.99	MN.35	XY98	XYZ12

Other Template Operators

These template operators assist in capturing, delimiting, and formatting scanned OCR data.

Literal String (" and +)



"



+

Use either of these delimiting characters surrounding characters from the alphanumeric keyboard in the *Advanced Data Formatting Guide* to define a literal string within a template that must be present in scanned OCR data. There are two characters used to delimit required literal strings; if one of the delimiter characters is present in the desired literal string, use the other delimiter.

Template	Valid data	Invalid data
"35+BC"	35+BC	AB+22

New Line (E)



E

To create a template of multiple lines, add **E** between the template of each single line.

Template	Valid data	Valid data	Invalid data
999EAAAA	321	987	XYZW
	BCAD	ZXYW	12

String Extract (C)



C

This operator combined with others defines a string of characters to extract from the scanned data. The string extract is structured as follows:

CbPe

Where:

- **C** is the string extract operator
- **b** is the string begin delimiter
- **P** is the category (one or more numeric or alpha characters) describing the string representation
- **e** is the string end delimiter

Values for **b** and **e** can be any scannable character. They are included in the output stream.

Template	Incoming data	Output
C>A>	XQ3>ABCDE>	>ABCDE>
	->ATHRUZ>123	>ATHRUZ>
	1ABCZXYZ	No Output

Ignore to End of Field (D)**D**

This operator causes all characters after a template to be ignored. Use this as the last character in a template expression. Examples for the template 999D:

Template	Incoming data	Output
999D	123-PED	123
	357298	357
	193	193

Skip Until (P1)**P****1**

This operator allows skipping over characters until a specific character type or a literal string is detected. It can be used in two ways:

```
P1ct
```

Where:

- P1 is the Skip Until operator
- c is the type of character that triggers the start of output
- t is one or more template characters

```
P1"s"t
```

Where:

- P1 is the Skip Until operator
- "s" is one or more literal string characters (see [Literal String \(" and +\) on page 278](#)) that trigger the start of output
- t is one or more template characters

The trigger character or literal string is included in output from a Skip Until operator, and the first character in the template should accommodate this trigger.

Template	Incoming data	Output
P1"PN"AA9999	123PN9876	PN9876
	PN1234	PN1234
	X-PN3592	PN3592

Skip Until Not (P0)



P



0

This operator allows skipping over characters until a specific character type or a literal string is not matched in the output stream. It can be used in two ways:

`P0ct`

Where:

- P0 is the Skip Until Not operator
- c is the type of character that triggers the start of output
- t is one or more template characters

`P0"s"t`

Where:

- P0 is the Skip Until Not operator
- "s" is one or more literal string characters (see [Literal String \(" and +\)](#) on page 278) that trigger the start of output
- t is one or more template characters

The trigger character or literal string is not included in output from a Skip Until Not operator.

Template	Incoming data	Output
P0A9999	BN3456	3456
	PN1234	1234
	5341	No output
P0"PN"9999	PN3456	3456
	5341	No output
	PNPN7654	7654

Repeat Previous (R)



R

This operator allows a template character to repeat one or more times, allowing the capture of variable-length scanned data. The following examples capture two required alpha characters followed by one or more required digits:

Template	Incoming data	Output
AA9R	AB3	AB3
	PN12345	PN12345
	32RM52700	No output

Scroll Until Match (S)



S

This operator steps through scanned data one character at a time until the data matches the template.

Template	Incoming data	Output
S99999	AB3	No Output
	PN12345	12345
	32RM52700	52700

Multiple Templates

This feature sets up multiple templates for OCR decoding. To do this, follow the procedure described in [OCR Template on page 273](#) (scan the [OCR Template](#) barcode, then barcodes corresponding to numbers and letters to form the template expression, then **End of Message**) for each template in the multiple template string, using a capital letter **X** as a separator between the templates.

For example, set the [OCR Template](#) as **99999XAAAAA** to decode OCR strings of either **12345** or **ABCDE**.

Template Examples

Following are sample templates with descriptions of valid data for each definition.

Field Definition	Description
"M"99977	M followed by three digits and two optional digits.
"X"997777"X"	X followed by two digits, four optional digits, and an X .
9959775599	Two digits followed by any character, a digit, two optional digits, any two characters, and two digits.
A55"- "999"- "99	A letter followed by two characters, a dash, three digits, a dash, and two digits.
33A". "99	Two alphanumeric characters followed by a letter, a period, and two digits.
999992991	Five digits followed by an optional alpha, two digits, and an optional alphanumeric.
"PN98"	Literal field - PN98

OCR Check Digit Modulus

Parameter # 688 (SSI # F1h B0h)

This option sets OCR module check digit calculation. The check digit is the last digit (in the right most position) in an OCR string and improves the accuracy of the collected data. The check digit is the end product of a calculation made on the incoming data. For check digit calculation, for example Modulus 10, alpha and numeric characters are assigned numeric weights (see [OCR Check Digit Multiplier on page 284](#)). The calculation is applied to the character weights and the resulting check digit is added to the end of the data. If the incoming data does not match the check digit, the data is considered corrupt.

The selected check digit option does not take effect until you set **OCR Check Digit Validation**.

To choose the Check Digit Modulus, such as 10 for modulo 10, scan the following barcode, then scan a three-digit number from 001 to 099 representing the check digit using the numeric keypad in the *Advanced Data Formatting Guide*. The default is 1.



OCR Check Digit

OCR Check Digit Multiplier

Parameter # 700 (SSI # F1h BCh)

This option sets OCR check digit multipliers for the character positions. For check digit validation, each character in scanned data has an equivalent weight used in the check digit calculation. MS47 OCR ships with the following weight equivalents:

0 = 0	A = 10	K = 20	U = 30
1 = 1	B = 11	L = 21	V = 31
2 = 2	C = 12	M = 22	W = 32
3 = 3	D = 13	N = 23	X = 33
4 = 4	E = 14	O = 24	Y = 34
5 = 5	F = 15	P = 25	Z = 35
6 = 6	G = 16	Q = 26	Space = 0
7 = 7	H = 17	R = 27	
8 = 8	I = 18	S = 28	
9 = 9	J = 19	T = 29	

All other characters are equivalent to one (1).

You can define the multiplier string if it is different from the default.

121212121212 (default)

123456789A (for ISBN, Product Add Right to Left. See [OCR Check Digit Validation on page 285](#).)

For example:

ISBN	0	2	0	1	1	8	3	9	9	4
Multiplier	10	9	8	7	6	5	4	3	2	1
Product	0	18	0	7	6	40	12	27	18	4
Product add	0+	18+	0+	7+	6+	40+	12+	27+	18+	4= 132

ISBN uses modulo 11 for its check digit. In this case, 132 is divisible by 11, so it passes the check digit.

To set the check digit multiplier, scan the following barcode, then scan numbers and letters to form the multiplier string from the alphanumeric keyboard in the *Advanced Data Formatting Guide*. Then scan **End of Message** in the *Advanced Data Formatting Guide*.



OCR Check Digit Multiplier

OCR Check Digit Validation

Parameter # 694 (SSI # F1h B6h)

Use **OCR Check Digit Validation** to protect against scanning errors by applying a check digit validation scheme. The following is a list of options.

None

No check digit validation, indicating no check digit is applied. This is the default.



*** No Check Digit
(0)**

Product Add Left to Right

Each character in the scanned data is assigned a numeric value (see [OCR Check Digit Multiplier on page 284](#)). Each digit representing a character in the scanned data is multiplied by its corresponding digit in the multiplier, and the sum of these products is computed. The check digit passes if this sum modulo Check Digit Modulus is zero.

Example:

Scanned data numeric value is 132456 (check digit is 6)

Check digit multiplier string is 123456

Digit	1	3	2	4	5	6
Multiplier	1	2	3	4	5	6
Product	1	6	6	16	25	36
Product add	1+	6+	6+	16+	25+	36= 90

The Check Digit Modulus is 10. It passes because 90 is divisible by 10 (the remainder is zero).



**Product Add Left to Right
(3)**

Product Add Right to Left

Each character in the scanned data is assigned a numeric value (see [OCR Check Digit Multiplier on page 284](#)). The check digit multiplier is reversed in order. Each value representing a character in the scanned data is multiplied by its corresponding digit in the reversed multiplier, resulting in a product for each character in the scanned data. The sum of these products is computed. The check digit passes if this sum modulo Check Digit Modulus is zero.

Example:

Scanned data numeric value is 132459 (check digit is 9)

Check digit multiplier string is 123456

Digit	1	3	2	4	5	9
Multiplier	6	5	4	3	2	1
Product	6	15	8	12	10	9
Product add	6+	15+	8+	12+	10+	9= 60

The Check Digit Modulus is 10. It passes because 60 is divisible by 10 (the remainder is 0).



**Product Add Right to Left
(1)**

Digit Add Left to Right

Each character in the scanned data is assigned a numeric value (see [OCR Check Digit Multiplier on page 284](#)). Each value representing a character in the scanned data is multiplied by its corresponding digit in the multiplier, resulting in a product for each character in the scanned data. The sum of each individual digit in all of the products is then calculated. The check digit passes if this sum modulo Check Digit Modulus is zero.

Example:

Scanned data numeric value is 132456 (check digit is 6)

Check digit multiplier string is 123456

Digit	1	3	2	4	5	6
Multiplier	1	2	3	4	5	6
Product	1	6	6	16	25	36
Digit add	1+	6+	6+	1+6+	2+5+	3+6= 36

The Check Digit Modulus is 12. It passes because 36 is divisible by 12 (the remainder is 0).



**Digit Add Left to Right
(4)**

Digit Add Right to Left

Each character in the scanned data is assigned a numeric value (see [OCR Check Digit Multiplier on page 284](#)). The check digit multiplier is reversed in order. Each value representing a character in the scanned data is multiplied by its corresponding digit in the reversed multiplier, resulting in a product for each character in the scanned data. The sum of each individual digit in all of the products is then calculated. The check digit passes if this sum modulo Check Digit Modulus is zero.

Example:

Scanned data numeric value is 132456 (check digit is 6)

Check digit multiplier string is 123456

Digit	1	3	2	4	5	6
Multiplier	6	5	4	3	2	1
Product	6	15	8	12	10	6
Digit add	6+	1+5+	8+	1+2+	1+0+	6= 30

The Check Digit Modulus is 10. It passes because 30 is divisible by 10 (the remainder is 0).



**Digit Add Right to Left
(2)**

Product Add Right to Left Simple Remainder

Each character in the scanned data is assigned a numeric value (see [OCR Check Digit Multiplier on page 284](#)). The check digit multiplier is reversed in order. Each value representing a character in the scanned data is multiplied by its corresponding digit in the reversed multiplier, resulting in a product for each character in the scanned data. The sum of these products **except for the check digit's product** is computed. The check digit passes if this sum modulo Check Digit Modulus is equal to the check digit's product.

Example:

Scanned data numeric value is 122456 (check digit is 6)

Check digit multiplier string is 123456

Digit	1	2	2	4	5	6
Multiplier	6	5	4	3	2	1
Product	6	10	8	12	10	6
Product add	6+	10+	8+	12+	10=	46 6

The Check Digit Modulus is 10. It passes because 46 divided by 10 leaves a remainder of 6.



**Product Add Right to Left Simple Remainder
(5)**

Digit Add Right To Left Simple Remainder

Each character in the scanned data is assigned a numeric value (see [OCR Check Digit Multiplier on page 284](#)). The check digit multiplier is reversed in order. Each value representing a character in the scanned data is multiplied by its corresponding digit in the reversed multiplier, resulting in a product for each character in the scanned data. The sum of each individual digit in all of the products **except for the check digit's product** is then calculated. The check digit passes if this sum modulo Check Digit Modulus is equal to the check digit's product.

Example:

Scanned data numeric value is 122459 (check digit is 6)

Check digit multiplier string is 123456

Digit	1	2	2	4	5	9
Multiplier	6	5	4	3	2	1
Product	6	10	8	12	10	9
Digit add	6+	1+0+	8+	1+2+	1+0=	19 9

The Check Digit Modulus is 10. It passes because 19 divided by 10 leaves a remainder of 9.



Digit Add Right to Left Simple Remainder
(6)

Health Industry - HIBCC43

This is the health industry module 43 check digit standard. The check digit is the modulus 43 sum of all the character values in a given message, and is printed as the last character in a given message.

Example:

Supplier Labeling Data Structure: + A 1 2 3 B J C 5 D 6 E 7 1

Sum of values: 41+10+1+2+3+11+19+12+5+13+6+14+7+1 = 145

Divide 145 by 43. The quotient is 3 with a remainder of 16. The check digit is the character corresponding to the value of the remainder, which in this example is 16, or **G**. The complete Supplier Labeling Data Structure, including the check digit, therefore is:

A 1 2 3 B J C 5 D 6 E 7 1 G

Table 26 Table of Numeric Value Assignments for Computing HIBC LIC Data Format Check Digit

0 = 0	9 = 9	I = 18	R = 27	- = 36
1 = 1	A = 10	J = 19	S = 28	. = 37
2 = 2	B = 11	K = 20	T = 29	Space = 38
3 = 3	C = 12	L = 21	U = 30	\$ = 39
4 = 4	D = 13	M = 22	V = 31	/ = 40
5 = 5	E = 14	N = 23	W = 32	+ = 41
6 = 6	F = 15	O = 24	X = 33	% = 42
7 = 7	G = 16	P = 25	Y = 34	
8 = 8	H = 17	Q = 26	Z = 35	



Health Industry - HIBCC43
(9)

Inverse OCR

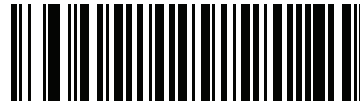
Parameter # 856 (SSI # F2h 58h)

Inverse OCR is white or light words on a black or dark background. Select an option for decoding inverse OCR:

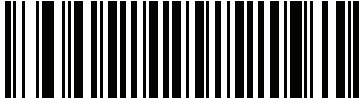
- **Regular Only** - decode regular OCR (black on white) strings only.
- **Inverse Only** - decode inverse OCR (white on black) strings only.
- **Autodiscriminate** - decodes both regular and inverse OCR strings.



* Regular Only
(0)



Inverse Only
(1)



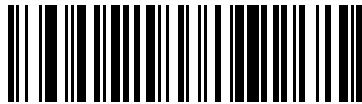
Autodiscriminate
(2)

OCR Redundancy

Parameter # 1770 (SSI # F8h 06h EAh)

This option adjusts the number of times to decode an OCR text string before transmission. There are three levels of OCR decode redundancy. There is an inverse relationship between the redundancy level and OCR decoding aggressiveness. Increasing the level of the redundancy can reduce OCR scanning aggressiveness, so select only the level of redundancy necessary.

- **OCR Redundancy Level 1:** This default setting allows the scanner to operate in its most aggressive state while providing sufficient accuracy in decoding most in-spec OCR text strings.
- **OCR Redundancy Level 2:** This setting eliminates most misdecodes while maintaining reasonable aggressiveness.
- **OCR Redundancy Level 3:** Select this option with greater redundancy requirements if OCR Redundancy Level 2 fails to eliminate misdecodes.



* OCR Redundancy Level 1
(1)



OCR Redundancy Level 2
(2)



OCR Redundancy Level 3
(3)

Driver's License Set Up

Introduction

The scanner uses internally embedded algorithms to parse out barcode information from standard US driver's licenses and certain other American Association of Motor Vehicle Administrators (AAMVA) compliant ID cards. Scanning these barcodes produces formatted data for use in age verification, credit card application information, and more.

This chapter describes how to program the scanner to read and use the data contained in the 2D barcodes on US driver's licenses and AAMVA compliant ID cards.

Table 27 DL Parsing Parameter Table

Parameter	Default	Page Number
DL Parsing Parameters		
Driver's License Parsing	No Driver's License Parsing	293
Parsing Driver's License Data Fields	N/A	294
Driver's License Parse Field Barcodes	N/A	295
AAMVA Parse Field Barcodes	N/A	297
Parser Version ID Barcode	N/A	306
Set Default Parameter	N/A	307
Output Gender as M or F	N/A	307
Date Format	CCYYMMDD	308
No Separator	N/A	309
Send Keystroke	N/A	310
Control Characters		310
Keyboard Characters		314
Parsing Rule Example	N/A	328
Embedded Driver's License Parsing ADF Example	N/A	332

Driver's License Parsing

Parameter # 645

SSI # F1 85

To enable driver's license parsing on the scanner, scan the **Embedded Driver's License Parsing** barcode. This does not require Zebra software (.DLL).

Scan the barcodes on the following pages in the order indicating the sequence of data fields that the scanner outputs. See [Parsing Driver's License Data Fields \(Embedded Driver's License Parsing\) on page 294](#) for more information.



***No Driver's License Parsing**



Embedded Driver's License Parsing

Parsing Driver's License Data Fields (Embedded Driver's License Parsing)

To program a parsing rule:

1. Scan [Begin New Driver's License Parse Rule on page 295](#).
2. Scan any of the field barcodes on the following pages, or [Send Keystroke \(Control Characters and Keyboard Characters\) on page 310](#).
3. After entering the entire rule, scan [Save Driver's License Parse Rule on page 295](#) to save the rule.



NOTE: The scanner stores only one driver's license parsing rule in memory at a time. Saving a new rule replaces the prior rule.

To abort the programming sequence at any time during programming, scan [Quit Entering Driver's License Rule on page 295](#). Any previously saved rule is retained.

To erase a saved rule, scan [Erase Driver's License Parse Rules on page 295](#).

Embedded Driver's License Parsing Criteria - Code Type

After specifying the fields and their order for the parsed driver's license, you can also apply standard ADF rules to the parsed data using the **Parsed Driver's License** criterion barcode in the *Advanced Data Formatting Programmer Guide*.



NOTE: Only create standard ADF rules on parsed driver's license data when configured for Embedded Driver's License Parsing.

See [Embedded Driver's License Parsing ADF Example on page 332](#) for a sample ADF rule using this code type criterion.

Driver's License Parse Field Barcodes



Begin New Driver's License Parse Rule



Save Driver's License Parse Rule



Quit Entering Driver's License Rule



Erase Driver's License Parse Rules

The supported parse fields begin below. Not all IDs present data in the same format. For example, some IDs can have separate fields for first name, last name, and middle initial, while others have a single field with the entire name. Also, some IDs expire on the subject's birth date while the expiration date field only indicates the year. To present data in a consistent format, use the following nine barcodes to return data calculated from the actual data contained in the ID barcode.

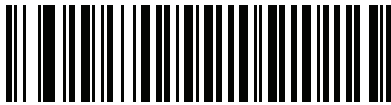


First Name



Middle Name/Initial

Driver's License Parse Field Barcodes (continued)



Last Name



Name Suffix



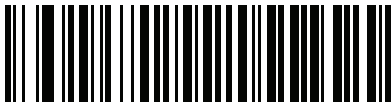
Name Prefix



Expiration Date



Birth Date



Issue Date

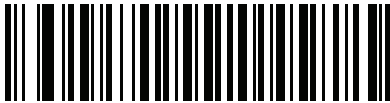


ID Number (Formatted)

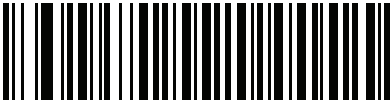
AAMVA Parse Field Barcodes



AAMVA Issuer ID



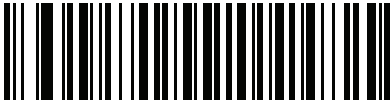
Full Name



Last Name



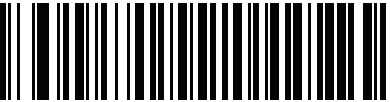
First Name



Middle Name / Initial



Name Suffix



Name Prefix

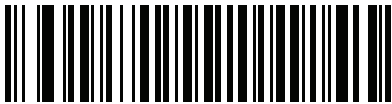
AAMVA Parse Field Barcodes (continued)



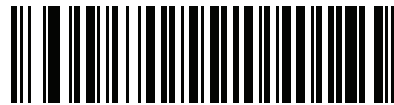
Mailing Address Line 1



Mailing Address Line 2



Mailing Address City



Mailing Address State



Mailing Address Postal Code



Home Address Line 1

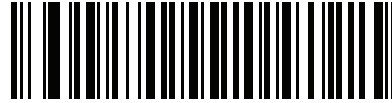


Home Address Line 2

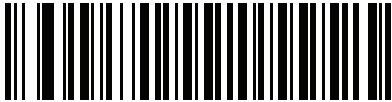
AAMVA Parse Field Barcodes (continued)



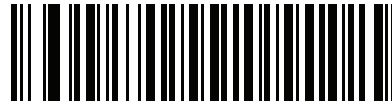
Home Address City



Home Address State



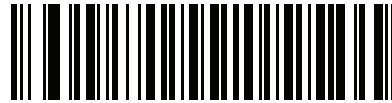
Home Address Postal Code



License ID Number



License Class



License Restrictions



License Endorsements

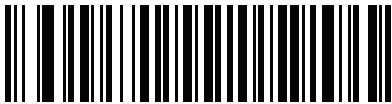
AAMVA Parse Field Barcodes (continued)



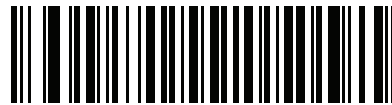
Height (Feet and/or Inches)



Height (Centimeters)



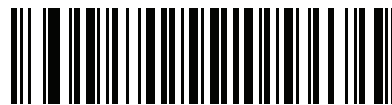
Weight (Pounds)



Weight (Kilograms)



Eye Color



Hair Color

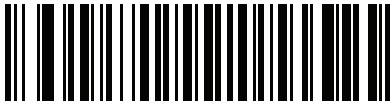


License Expiration Date

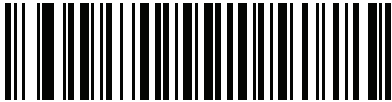
AAMVA Parse Field Barcodes (continued)



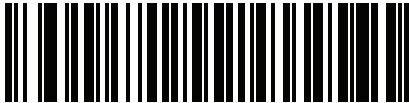
Birth Date



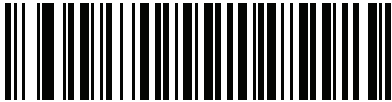
Gender



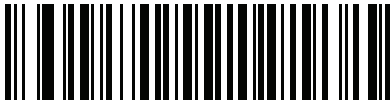
License Issue Date



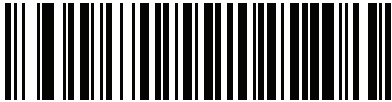
License Issue State



Social Security Number



Permit Class

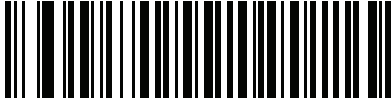


Permit Expiration Date

AAMVA Parse Field Barcodes (continued)



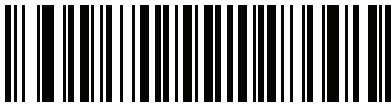
Permit ID Number



Permit Issue Date



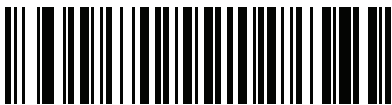
Permit Restrictions



Permit Endorsements



AKA Social Security Name



AKA Full Name



AKA Last Name



AKA First Name

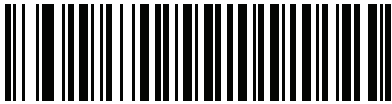
AAMVA Parse Field Barcodes (continued)



AKA Middle Name / Initial



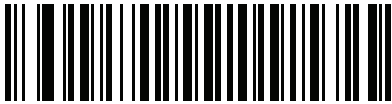
AKA Name Suffix



AKA Name Prefix



AKA Birth Date



Issue Timestamp

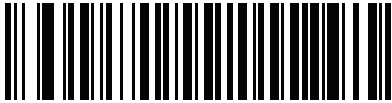


Number of Duplicates



Medical Codes

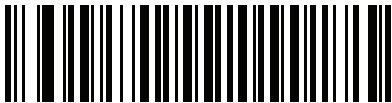
AAMVA Parse Field Barcodes (continued)



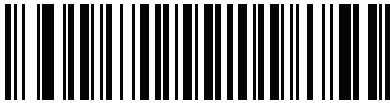
Organ Donor



Nonresident



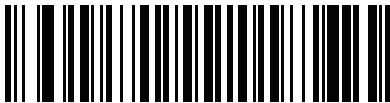
Customer ID



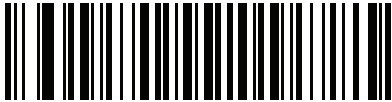
Weight Range



Document Discriminator



Country



Federal Commission Codes

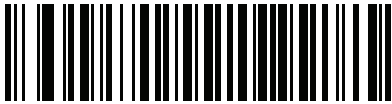
AAMVA Parse Field Barcodes (continued)



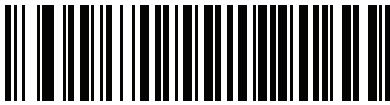
Place of Birth



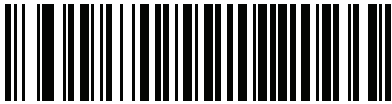
Audit Information



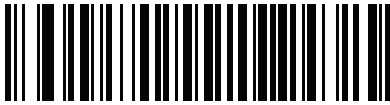
Inventory Control



Race / Ethnicity



Std Vehicle Class



Std Endorsements

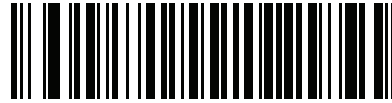


Std Restrictions

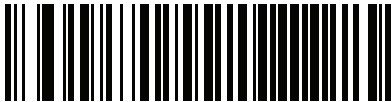
AAMVA Parse Field Barcodes (continued)



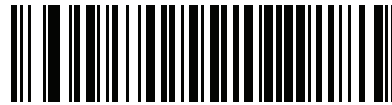
Class Description



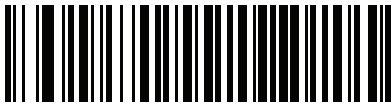
Endorsement Description



Restrictions Description



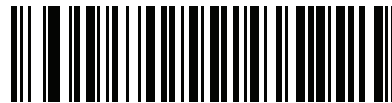
Height in Inches



Height in Centimeters

Parser Version ID Barcode

Include this field to emit embedded parser software version identification



Parser Version ID

User Preferences

Set Default Parameter

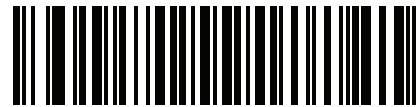
Scan this barcode to return all parameters to their default values..



***Set All Defaults**

Output Gender as M or F

Scan this barcode to report the gender as **M** or **F** instead of a numeric value.



Output gender as M or F

Date Format

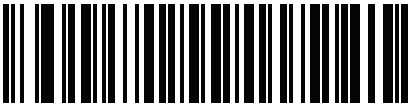
Use these barcodes to select the date format to display. Date fields include the following:

- **CCYY** = 4-digit year (**CC**=2-digit century [00-99], **YY**=2-digit year in the century [00-99])
- **MM** = 2-digit month [01-12]
- **DD** = 2-digit day of the month [00-31]

The default is **CCYYMMDD**.



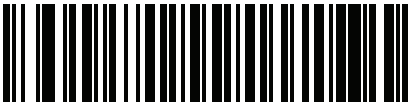
NOTE: To specify a date separator, i.e., a character separating each field of the date, scan the **Send <character>** barcode that corresponds to the alphanumeric character to use as the date separator immediately following the date format barcode. To select no date separator, scan the **No Separator DL** parsing rule immediately following the date format barcode.



*CCYYMMDD



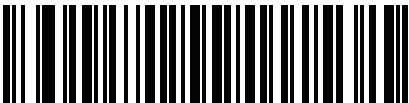
CCYYDDMM



MMDDCCYY



MMCCYYDD



DDMMCCYY



DDCCYYMM

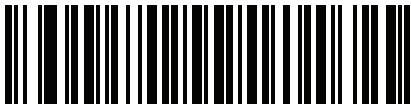
Date Format (continued)



YYMMDD



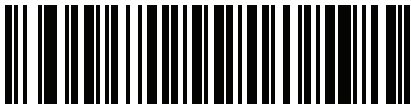
YYDDMM



MMDDYY



MMYDD



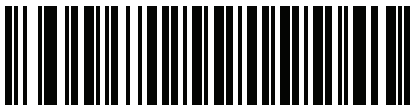
DDMMYY



DDYYMM

No Separator

Scan this barcode immediately following a date format barcode to use no separator character between the date fields.



No Separator

Send Keystroke (Control Characters and Keyboard Characters)

Control Characters

Scan a **Send** barcode for the keystroke to send.



Send Control A



Send Control B



Send Control C



Send Control D



Send Control E



Send Control F



Send Control G



Send Control H

Control Characters (continued)



Send Control I



Send Control J



Send Control K



Send Control L



Send Control M



Send Control N



Send Control O



Send Control P

Control Characters (continued)



Send Control Q



Send Control R



Send Control S



Send Control T



Send Control U



Send Control V



Send Control W

Control Characters (continued)



Send Control X



Send Control Y



Send Control Z



Send Control [



**Send Control **



Send Control]

Control Characters (continued)



Send Control 6



Send Control -

Keyboard Characters

Scan a **Send** barcode for the keyboard characters to send.



Send Space



Send !



Send “



Send #

Keyboard Characters (continued)



Send \$



Send %



Send &



Send ‘



Send (



Send)



Send *

Keyboard Characters (continued)



Send +



Send ,



Send -



Send .



Send /



Send 0



Send 1

Keyboard Characters (continued)



Send 2



Send 3



Send 4



Send 5



Send 6



Send 7



Send 8

Keyboard Characters (continued)



Send 9



Send :



Send ;



Send <



Send =



Send >



Send ?

Keyboard Characters (continued)



Send @



Send A



Send B



Send C



Send D



Send E



Send F

Keyboard Characters (continued)



Send G



Send H



Send I



Send J



Send K



Send L



Send M

Keyboard Characters (continued)



Send N



Send O



Send P



Send Q



Send R



Send S



Send T

Keyboard Characters (continued)



Send U



Send V



Send W



Send X



Send Y



Send Z



Send [

Keyboard Characters (continued)



Send \



Send]



Send ^



Send _



Send `



Send a



Send b

Keyboard Characters (continued)



Send c



Send d



Send e



Send f



Send g



Send h



Send i

Keyboard Characters (continued)



Send j



Send k



Send l



Send m



Send n



Send o



Send p

Keyboard Characters (continued)



Send q



Send r



Send s



Send t



Send u



Send v



Send w

Keyboard Characters (continued)



Send x



Send y



Send z



Send {



Send |



Send }



Send ~

Keyboard Characters (continued)



Send Tab Key



Send Enter Key

Parsing Rule Example

Scan the following barcodes in sequence to program the scanner to extract and transmit first, middle, and last names; mailing address line 1; mailing address line 2; mailing address city; mailing address state; mailing address postal code; and, date of birth. Then, scan a driver's license barcode.



NOTE: This example applies to RS-232. To use this example with a USB interface, enable [Function Key Mapping on page 123](#) to send the **Enter** key properly.

1



Embedded Driver's License Parsing

2



Begin New Driver's License Parse Rule

3



First Name

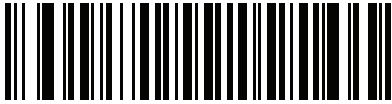
Parsing Rule Example (continued)

4



Send Space

5



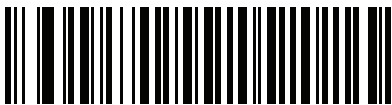
Middle Name / Initial

6



Send Space

7



Last Name

8



Send Enter Key

9



Mailing Address Line 1

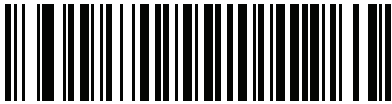
Parsing Rule Example (continued)

10



Send Space

11



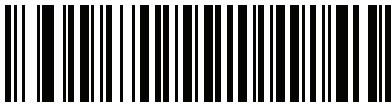
Mailing Address Line 2

12



Send Enter Key

13



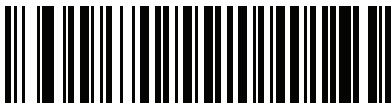
Mailing Address City

14



Send Space

15



Mailing Address State

Parsing Rule Example (continued)

16



Send Space

17



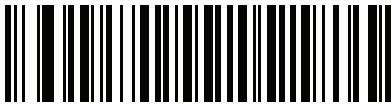
Mailing Address Postal Code

18



Send Enter Key

19



Birth Date

20



Send Enter Key

21



Save Driver's License Parse Rule

Embedded Driver's License Parsing ADF Example

This example creates a parsing rule for parsed data configured to result in the format:

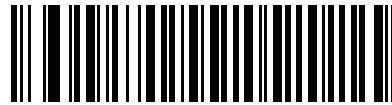
Last Name, First Name

1



Begin New Driver's License Parse Rule

2



Last Name

3



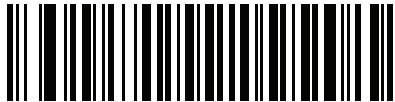
Send ,

4



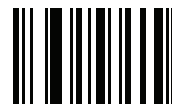
Send Space

5



First Name

6



Save Driver's License Parse Rule

Then, in order to limit the full name to 15 characters, create the following ADF rule:

1



Begin New Rule

2



Criterion: Parsed Driver's License

3



Action: Send Next 15 Characters

4



Save Rule

For a license belonging to Michael Williams, the parsed data is Williams, Michael and Williams, Micha after applying the previous ADF rule.

Standard Default Parameters

Table 28 Parameter Defaults

Parameter	Parameter Number	SSI Number	Default	Page Number
User Preferences				
Set Default Parameter	N/A	N/A	Restore Defaults	59
Parameter Barcode Scanning	236	ECh	Enable	60
Beep After Good Decode	56	38h	Enable	61
Beep on <BEL>	150	96h	Enable	61
Lock/Unlock	802/803	F2h 22h/ F2h 23h	N/A	62
Beeper Volume	140	8Ch	High	63
Beeper Tone	145	91h	Medium	64
Beeper Duration	628	F1h 74h	Medium	65
Suppress Power Up Beeps	721	F1h D1h	Do Not Suppress	65
Trigger Mode	138	8Ah	Presentation Mode	66
Presentation Decode Aiming Pattern	590	F1h 4Eh	Enable	67
Picklist Mode	402	F0h 92h	Disabled Always	68
Decode Session Timeout	136	88h	9.9 Seconds	69
Hands-Free Decode Session Timeout	400	F0h 90h	15	69
Timeout Between Decodes, Same Symbol	137	89h	0.5 Seconds	71
Timeout Between Decodes, Different Symbols	144	90h	0.1 Seconds	71
Mobile Phone/Display Mode	716	F1h CCh	Disable	72

Table 28 Parameter Defaults (Continued)

Parameter	Parameter Number	SSI Number	Default	Page Number
Scene Detect Mode (Wakeup)	2377	F8 09 49	Object Detect	73
PDF Prioritization	719	F1h CFh	Disable	73
PDF Prioritization Timeout	720	F1h D0h	200 msec	75
Low Light Motion Detection Assist	810	F2h 2Ah	Disable Low Light Motion Detection Assist	76
Presentation Mode Field of View	609	F1h 61h	Full	77
Scene Detect Sensitivity	1943	F8h 97h	Medium	78
Decoding Illumination	298	F0h 2Ah	Enable	79
Add an Enter Key	N/A	N/A	N/A	79
Transmit Code ID Character	45	2Dh	None	80
Prefix Value	99, 105	63h, 69h	7013 <CR><LF>	81
Suffix 1 Value Suffix 2 Value	98, 104 100, 106	62h, 68h 64h, 6Ah	7013 <CR><LF>	81
Scan Data Transmission Format	235	EBh	Data as is	82
FN1 Substitution Values	103, 109	67h, 6Dh	7013 <CR><LF>	83
Transmit "No Read" Message	94	5E	Disable	84
Unsolicited Heartbeat Interval	1118	F8h 04h 5Eh	Disable	85
Report Version	N/A	N/A	N/A	86
Report Decoder Manufacturing Information	N/A	N/A	N/A	86
Report Engine Manufacturing Information	N/A	N/A	N/A	86
Imaging Preferences				
Operational Modes	N/A	N/A	N/A	90
Aim Brightness	668	F1h 9Ch	High	91
Illumination Brightness	669	F1h 9Dh	10	91
Image Capture Illumination	361	F0h 69h	Enable	92
Image Capture Autoexposure	360	F0h 68h	Enable	92
Fixed Exposure	567	F4h F1h 37h	100	94
Gain / Exposure Priority for Snapshot Mode	562	F1h 32h	Autodetect	95

Standard Default Parameters

Table 28 Parameter Defaults (Continued)

Parameter	Parameter Number	SSI Number	Default	Page Number
Snapshot Mode Timeout	323	F0h 43h	0 (30 Seconds)	96
Snapshot Aiming Pattern	300	F0h 2Ch	Enable	97
Silence Operational Mode Changes	1293	F8h 05h 0Dh	Do Not Silence (Disable)	97
Image Cropping	301	F0h 2Dh	Disable	98
Crop to Pixel Addresses	315 316 317 318	F4h F0h 3Bh F4h F0h 3Ch F4h F0h 3Dh F4h F0h 3Eh	0 top 0 left 959 bottom 1279 right	99
Image Size (Number of Pixels)	302	F0h 2Eh	Full	100
Image Brightness (Target White)	390	F0h 86h	180	101
JPEG Image Options	299	F0h 2Bh	Quality	101
JPEG Target File Size	561	F1h 31h	160 kB	102
JPEG Quality	305	F0h 31h	65	102
Image Enhancement	564	F1h 34h	1 (Low)	103
Image File Format Selector	304	F0h 30h	JPEG	104
Image Rotation	665	F1h 99h	0°	105
Bits per Pixel (BPP)	303	F0h 2Fh	8 BPP	106
Signature Capture	93	5Dh	Disable	107
Signature Capture Image File Format Selection	313	F0h 39h	JPEG	108
Signature Capture Bits Per Pixel	314	F0h 3Ah	8 BPP	109
Signature Capture Width	366	F4h F0h 6Eh	400	110
Signature Capture Height	367	F4h F0h 6Fh	100	110
Signature Capture JPEG Quality	421	F0h A5h	65	110
Video View Finder	324	F0h 44h	Disable	111
Video View Finder Image Size	329	F0h 49h	1700 bytes	111
USB Host Parameters				
USB Device Type	N/A	N/A	HID Keyboard Emulation	116
Symbol Native API (SNAPI) Status Handshaking	N/A	N/A	Enable	118

Standard Default Parameters

Table 28 Parameter Defaults (Continued)

Parameter	Parameter Number	SSI Number	Default	Page Number
USB Keystroke Delay	N/A	N/A	No Delay	118
USB CAPS Lock Override	N/A	N/A	Disable	119
USB Ignore Unknown Characters	N/A	N/A	Send Barcodes with Unknown Characters	120
USB Convert Unknown to Code 39	N/A	N/A	Disable	120
Emulate Keypad	N/A	N/A	Enable	121
Emulate Keypad with Leading Zero	N/A	N/A	Enable	121
Quick Keypad Emulation	N/A	N/A	Enable	122
USB FN1 Substitution	N/A	N/A	Disable	122
Function Key Mapping	N/A	N/A	Disable	123
Simulated Caps Lock	N/A	N/A	Disable	123
Convert Case	N/A	N/A	No Case Conversion	124
USB CDC Host Variant	1713	N/A	Standard USB CDC	125
USB Static CDC	N/A	N/A	Enable	125
Product ID (PID) Type	1281	F8h 05h 01h	Host Type Unique	126
Product ID (PID) Value	1725	F8h 06h BDh	N/A	126
Datalogic Host Format	2253	F8 08 CD	Enable	127
Datalogic Supported Commands	2260	F8 08 D4	Disable	127
Ignore Beep Directive	N/A	N/A	Enable (Ignore)	128
Ignore Barcode Configuration	N/A	N/A	Enable (Ignore)	128
USB Polling Interval	N/A	N/A	3 msec	129
USB Fast HID	N/A	N/A	Enable	131
IBM Specification Version	N/A	N/A	Version 2.2	131
SSI Interface				
Software Handshaking	159	9Fh	ACK/NAK	141
Decode Data Packet Format	238	EEh	Send Raw Decode Data	142
Host Serial Response Time-out	155	9Bh	2 Seconds	143
Host Character Time-out	239	EFh	200 msec	144
Multipacket Option	334	F0h 4Eh	Option 1	145

Table 28 Parameter Defaults (Continued)

Parameter	Parameter Number	SSI Number	Default	Page Number
Interpacket Delay	335	F0h 4Fh	0 msec	146
Event Reporting				
Decode Event	256	F0h 00h	Disable	147
Boot Up Event	258	F0h 02h	Disable	148
Parameter Event	259	F0h 03h	Disable	148
Enable/Disable All Code Types				156
1D Symbolologies				
UPC/EAN				
UPC-A	1	01h	Enable	157
UPC-E	2	02h	Enable	157
UPC-E1	12	0Ch	Disable	158
EAN-8/JAN 8	4	04h	Enable	158
EAN-13/JAN 13	3	03h	Enable	159
Bookland EAN	83	53h	Disable	159
Decode UPC/EAN/JAN Supplementals (2 and 5 digits)	16	10h	Ignore	160
User-Programmable Supplementals	579	F1h 43h	000	163
Supplemental 1: Supplemental 2:	580	F1h 44h		
UPC/EAN/JAN Supplemental Redundancy	80	50h	10	163
Decode UPC/EAN/JAN Supplemental AIM ID	672	F1h A0h	Add Format	164
UPC Reduced Quiet Zone	1289	F8h 05h 09h	Disable	165
Transmit UPC-A Check Digit	40	28h	Enable	165
Transmit UPC-E Check Digit	41	29h	Enable	166
Transmit UPC-E1 Check Digit	42	2Ah	Enable	166
UPC-A Preamble	34	22h	System Character	167
UPC-E Preamble	35	23h	System Character	168
UPC-E1 Preamble	36	24h	System Character	169
Convert UPC-E to A	37	25h	Disable	170

Standard Default Parameters

Table 28 Parameter Defaults (Continued)

Parameter	Parameter Number	SSI Number	Default	Page Number
Convert UPC-E1 to A	38	26h	Disable	170
EAN-8/JAN-8 Extend	39	27h	Disable	171
Bookland ISBN Format	576	F1h 40h	ISBN-10	171
UCC Coupon Extended Code	85	55h	Disable	172
Coupon Report	730	F1h DAh	New Coupon Format	173
ISSN EAN	617	F1h 69h	Disable	173
Code 128				
Code 128	8	08h	Enable	174
Set Length(s) for Code 128	209, 210	D1h, D2h	1 to 55	175
GS1-128 (formerly UCC/EAN-128)	14	0Eh	Enable	176
ISBT 128	84	54h	Disable	176
ISBT Concatenation	577	F1h 41h	Autodiscriminate	177
Check ISBT Table	578	F1h 42h	Enable	178
ISBT Concatenation Redundancy	223	DFh	10	178
Code 128 Security Level	751	F1h EFh	Security Level 1	179
Code 128 Reduced Quiet Zone	1208	F8h 04h B8h	Disable	180
Ignore Code 128 <FNC4>	1254	F8h 04h E6h	Disable	180
Code 39				
Code 39	0	00h	Enable	181
Trioptic Code 39	13	0Dh	Disable	181
Convert Code 39 to Code 32 (Italian Pharmacy Code)	86	56h	Disable	182
Code 32 Prefix	231	E7h	Disable	182
Set Length(s) for Code 39	18, 19	12h, 13h	1 to 55	183
Code 39 Check Digit Verification	48	30h	Disable	184
Transmit Code 39 Check Digit	43	2Bh	Disable	184
Code 39 Full ASCII Conversion	17	11h	Disable	185
Code 39 Security Level	750	F1h EEh	Security Level 1	186
Code 39 Reduced Quiet Zone	1209	F8h 04h B9h	Disable	187

Standard Default Parameters

Table 28 Parameter Defaults (Continued)

Parameter	Parameter Number	SSI Number	Default	Page Number
Code 93				
Code 93	9	09h	Enable	187
Set Length(s) for Code 93	26, 27	1Ah, 1Bh	1 to 55	188
Code 11				
Code 11	10	0Ah	Disable	189
Set Lengths for Code 11	28, 29	1Ch, 1Dh	4 to 55	190
Code 11 Check Digit Verification	52	34h	Disable	191
Transmit Code 11 Check Digit(s)	47	2Fh	Disable	192
Interleaved 2 of 5 (ITF)				
Interleaved 2 of 5 (ITF)	6	06h	Disable	192
Set Lengths for I 2 of 5	22, 23	16h, 17h	6 to 55	193
I 2 of 5 Check Digit Verification	49	31h	Disable	194
Transmit I 2 of 5 Check Digit	44	2Ch	Disable	195
Convert I 2 of 5 to EAN 13	82	52h	Disable	195
I 2 of 5 Security Level	1121	F8h 04h 61h	Security Level 1	196
I 2 of 5 Reduced Quiet Zone	1210	F8h 04h BAh	Disable	197
Discrete 2 of 5 (DTF)				
Discrete 2 of 5	5	05h	Disable	197
Set Length(s) for D 2 of 5	20, 21	14h 15h	1 to 55	198
Codabar (NW - 7)				
Codabar	7	07h	Enable	199
Set Lengths for Codabar	24, 25	18h, 19h	4 to 55	200
CLSI Editing	54	36h	Disable	201
NOTIS Editing	55	37h	Disable	201
Codabar Upper or Lower Case Start/Stop Characters Detection	855	F2h 57h	Upper Case	202
Codabar Security Level	1776	F8h 06h F0h	Security Level 1	203
Codabar Mod 16 Check Digit Verification	1784	F8h 06h F8h	Disable	204
Transmit Codabar Check Digit	704	F1h C0h	Disable	204

Standard Default Parameters

Table 28 Parameter Defaults (Continued)

Parameter	Parameter Number	SSI Number	Default	Page Number
MSI				
MSI	11	0Bh	Disable	205
Set Length(s) for MSI	30, 31	1Eh, 1Fh	4 to 55	206
MSI Check Digits	50	32h	One	207
Transmit MSI Check Digit(s)	46	2Eh	Disable	207
MSI Check Digit Algorithm	51	33h	Mod 10/Mod 10	208
Chinese 2 of 5				
Chinese 2 of 5	408	F0h 98h	Disable	208
Matrix 2 of 5				
Matrix 2 of 5	618	F1h 6Ah	Disable	209
Matrix 2 of 5 Lengths	619 620	F1h 6Bh F1h 6Ch	4 to 55	210
Matrix 2 of 5 Check Digit	622	F1h 6Eh	Disable	211
Transmit Matrix 2 of 5 Check Digit	623	F1h 6Fh	Disable	211
Korean 3 of 5				
Korean 3 of 5	581	F1h 45h	Disable	212
Inverse 1D	586	F1h 4Ah	Regular	213
GS1 DataBar				
GS1 DataBar-14	338	F0h 52h	Enable	214
GS1 DataBar Limited	339	F0h 53h	Enable	214
GS1 DataBar Expanded	340	F0h 54h	Enable	215
Convert GS1 DataBar to UPC/EAN	397	F0h 8Dh	Disable	215
GS1 DataBar Security Level	1706	F8h 06h AAh	Security Level 1	216
GS1 DataBar Limited Security Level	728	F1h D8h	Level 3	217
GS1 Digital Link				
GS1 Digital Link	2373	F8h 09h 45h	Disable	218
GS1 Digital Link Mode	2374	F8h 09h 46h	Mode 1 (GTIN Only)	218
GS1 Digital Link Prioritization Timeout	2491	F8h 09h BBh	200 ms	219

Standard Default Parameters

Table 28 Parameter Defaults (Continued)

Parameter	Parameter Number	SSI Number	Default	Page Number
Composite				
Composite CC-C	341	F0h 55h	Disable	220
Composite CC-A/B	342	F0h 56h	Disable	220
Composite TLC-39	371	F0h 73h	Disable	221
Composite Inverse	1113	F8h 04h 59h	Regular Only	221
UPC Composite Mode	344	F0h 58h	UPC Never Linked	222
Composite Beep Mode	398	F0h 8Eh	Beep As Each Code Type is Decoded	223
GS1-128 Emulation Mode for UCC/EAN Composite Codes	427	F0h ABh	Disable	223
2D Symbolologies				
PDF417	15	0Fh	Enable	224
MicroPDF417	227	E3h	Disable	224
Code 128 Emulation	123	7Bh	Disable	225
Data Matrix	292	F0h 24h	Enable	226
GS1 Data Matrix	1336	F8h 05h 38h	Disable	226
Data Matrix Inverse	588	F1h 4Ch	Inverse Autodetect	227
Maxicode	294	F0h 26h	Disable	227
QR Code	293	F0h 25h	Enable	228
GS1 QR	1343	F8h 05h 3Fh	Disable	228
MicroQR	573	F1h 3Dh	Enable	229
Linked QR Mode	1847	737h	Linked QR Only	229
Aztec	574	F1h 3Eh	Enable	230
Aztec Inverse	589	F1h 4Dh	Inverse Autodetect	230
Han Xin	1167	F8h 04h 8Fh	Disable	231
Han Xin Inverse	1168	F8h 04h 90h	Regular	231
Grid Matrix	1718	F8 06h B6h	Disable	232
Grid Matrix Inverse	1719	F8h 06h B7h	Regular Only	232
Grid Matrix Mirrored	1736	F8h 06h C8h	Non-Mirrored Only	233
DotCode	1906	F8 07 72h	Disable	234
DotCode Inverse	1907	F8 07 73h	Autodetect	234

Table 28 Parameter Defaults (Continued)

Parameter	Parameter Number	SSI Number	Default	Page Number
DotCode Mirrored	1908	F8 07 74h	Autodetect	235
DotCode Prioritize	1937	F8 07 91h	Disable	235
DotCode Erasure Limit	2063	F8 08 0F	10	236
Postal Codes				
US Postnet	89	59h	Disable	237
US Planet	90	5Ah	Disable	237
Transmit US Postal Check Digit	95	5Fh	Enable	238
UK Postal	91	5Bh	Disable	238
Transmit UK Postal Check Digit	96	60h	Enable	239
Japan Postal	290	F0h 22h	Disable	239
Australia Post	291	F0h 23h	Disable	240
Australia Post Format	718	F1h CEh	Autodiscriminate	241
Netherlands KIX Code	326	F0h 46h	Disable	242
USPS 4CB/One Code/Intelligent Mail	592	F1h 50h	Disable	242
UPU FICS Postal	611	F1h 63h	Disable	243
Mailmark	1337	F8h 05h 08h	Disable	243
Symbology-Specific Security Levels				
Redundancy Level	78	4Eh	1	244
Security Level	77	4Dh	1	246
1D Quiet Zone Level	1288	F8h 05h 08h	1	247
Intercharacter Gap Size	381	F0h 7Dh	Normal	248
Report Version				248
Macro PDF				
Flush Macro PDF Buffer	N/A	N/A	N/A	249
Abort Macro PDF Entry	N/A	N/A	N/A	249
OCR Programming Parameters				
OCR-A	680	F1h A8h	Disable	261
OCR-A Variant	684	F1h ACh	Full ASCII	261
OCR-B	681	F1h A9h	Disable	263
OCR-B Variant	685	F1h ADh	Full ASCII	264

Standard Default Parameters

Table 28 Parameter Defaults (Continued)

Parameter	Parameter Number	SSI Number	Default	Page Number
MICR E13B	682	F1h AAh	Disable	267
US Currency	683	F1h ABh	Disable	268
OCR Orientation	687	F1h AFh	0°	268
OCR Lines	691	F1h B3h	1	270
OCR Minimum Characters	689	F1h B1h	3	270
OCR Maximum Characters	690	F1h B2h	100	271
OCR Subset	686	F1h AEh	Selected font variant	271
OCR Quiet Zone	695	F1h B7h	50	272
OCR Template	547	F1h 23h	99999999	273
OCR Check Digit Modulus	688	F1h B0h	1	283
OCR Check Digit Multiplier	700	F1h BCh	121212121212	284
OCR Check Digit Validation	694	F1h B6h	None	285
Inverse OCR	856	F2h 58h	Regular	290
OCR Redundancy	1770	F8h 06h EAh	Level 1	291
Digimarc Digital Watermarks				
Digimarc Digital Watermarks	1687	F8h 06h 97h	Disabled	251
Digimarc Data Mode	2257	F8h 09h B8h	Compatible	252
Digimarc GIA17 Format	2488	F8h 09h 6Ch	Enabled	253
DL Parsing Parameters				
Driver's License Parsing	No Driver's License Parsing	N/A	No Driver's License Parsing	293
Parsing Driver's License Data Fields	N/A	N/A	N/A	294
Driver's License Parse Field Barcodes	N/A	N/A	N/A	296
AAMVA Parse Field Barcodes	N/A	N/A	N/A	297
Parser Version ID Barcode	N/A	N/A	N/A	306
Set Default Parameter	N/A	N/A	N/A	307
Output Gender as M or F	N/A	N/A	N/A	307
Date Format	N/A	N/A	CCYYMMDD	308
No Separator	N/A	N/A	N/A	309

Table 28 Parameter Defaults (Continued)

Parameter	Parameter Number	SSI Number	Default	Page Number
Send Keystroke	N/A	N/A	N/A	310
Control Characters				310
Keyboard Characters				314
Parsing Rule Example	N/A	N/A	N/A	328
Embedded Driver's License Parsing ADF Example	N/A	N/A	N/A	332

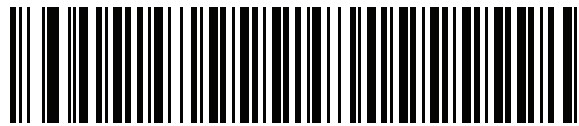
Country Codes

Introduction

This chapter provides instructions for programming the keyboard to interface with USB. The host powers the imager. For host setup information, see [USB Interface](#).

To select a code page for the country keyboard type, see Country Code Pages.

Throughout the programming barcode menus, default values are indicated with asterisks (*).



*Indicates Default — * **US English (North American)** — Feature/Option

USB Country Keyboard Types (Country Codes)

Scan the barcode corresponding to the keyboard type. For a USB host, this setting applies only to the USB Keyboard (HID) device. If the keyboard type is not listed, see [Quick Keypad Emulation on page 122](#) for the USB HID host.



NOTE: When changing USB country keyboard types the digital imager automatically resets and issues the standard startup beep sequences.

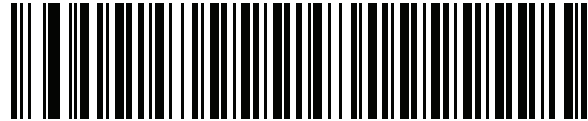


NOTE: For best results when using international keyboards, enable [Quick Keypad Emulation on page 122](#).

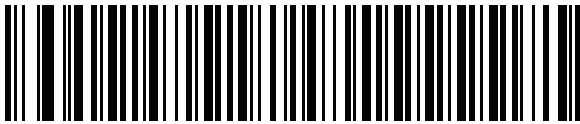


IMPORTANT: 1. Some country keyboard barcode types are specific to certain Windows Operating Systems (i.e., XP, and Win 7 or higher). Barcodes requiring a specific Windows OS are noted so in their barcode captions.

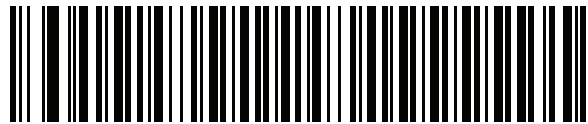
2. Use the **French International** barcode for Belgian French keyboards.



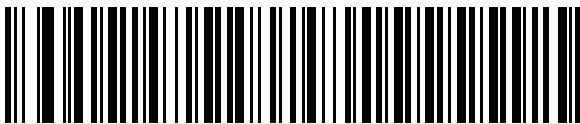
* US English (North American)



US English (Mac)



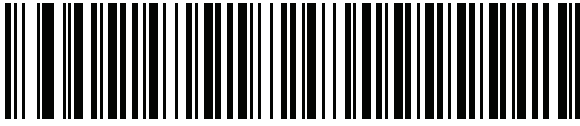
Albanian



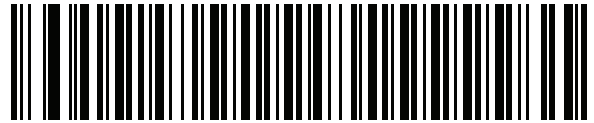
Arabic (101)



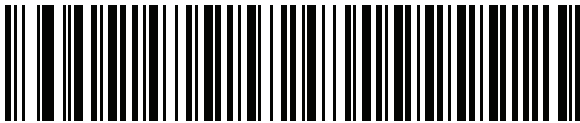
Arabic (102)



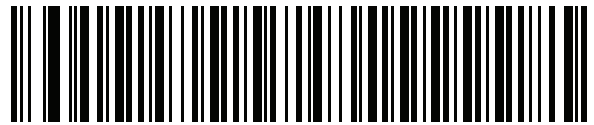
Arabic (102) AZERTY



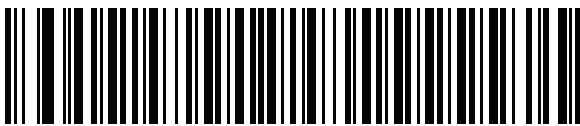
Azeri (Latin)



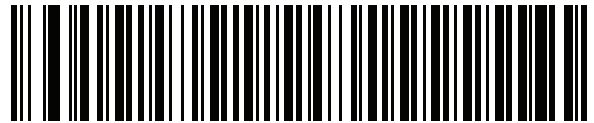
Azeri (Cyrillic)



Belarusian



Bosnian (Latin)



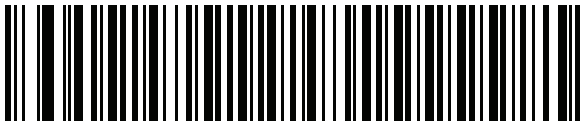
Bosnian (Cyrillic)



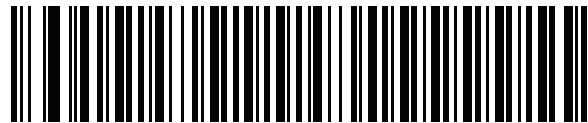
Bulgarian (Latin)



**Bulgarian Cyrillic (Typewriter)
(Bulgarian -Windows XP
Typewriter - Win 7 or higher)**



Canadian French Win7



Canadian French (Legacy)



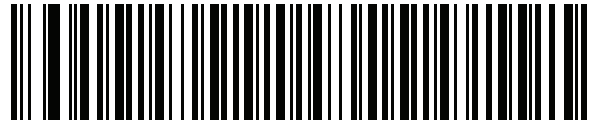
Canadian Multilingual Standard



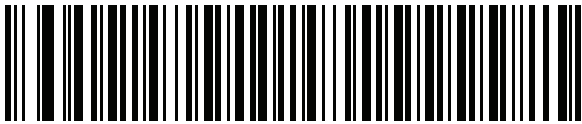
Chinese (ASCII)



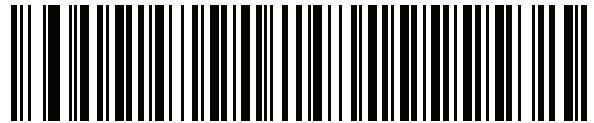
Chinese (Simplified) *



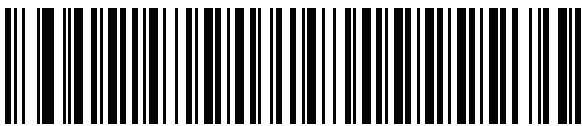
Chinese (Traditional) *



Croatian



Czech



Czech (Programmer)



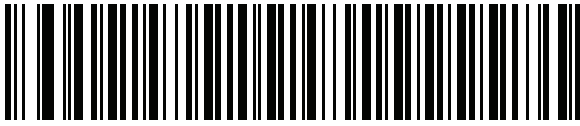
Czech (QWERTY)



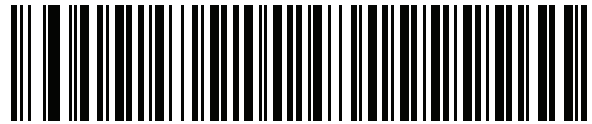
Danish



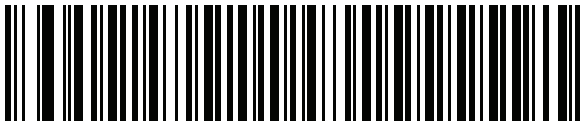
Dutch (Netherlands)



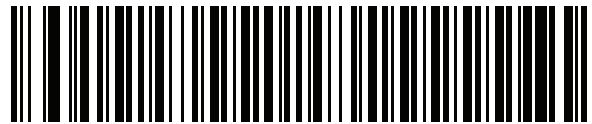
Estonian



Faeroese



Finnish



French (France)



**French International
(Belgian French)**



French (Canada) 95/98



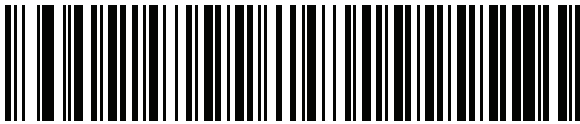
French (Canada) 2000/XP *

Country Codes

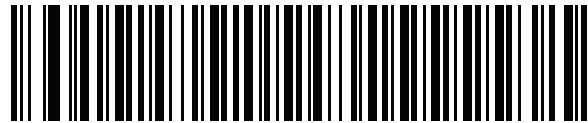
* Note that there is also a country code barcode for [Canadian Multilingual Standard on page 349](#). Be sure to select the appropriate barcode for your host system.



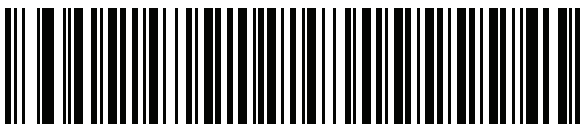
Galician



German



Greek Latin



Greek (220) Latin



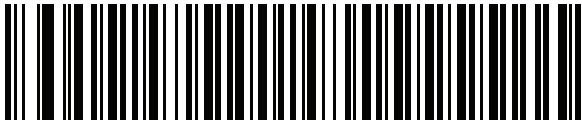
Greek (319) Latin



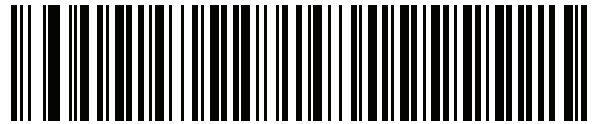
Greek



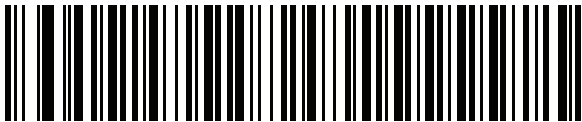
Greek (220)



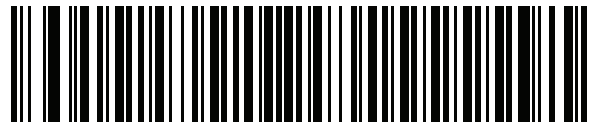
Greek (319)



Greek Polytonic



Hebrew Israel



Hungarian



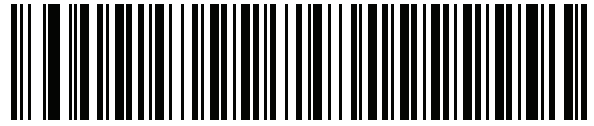
Hungarian_101KEY



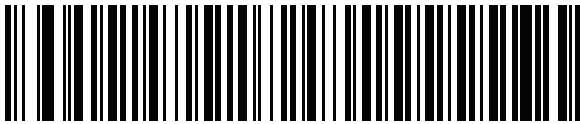
Icelandic



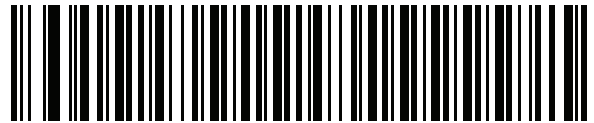
Irish



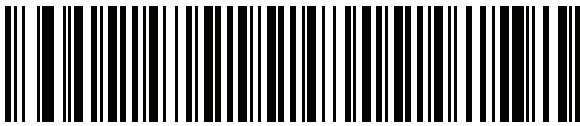
Italian



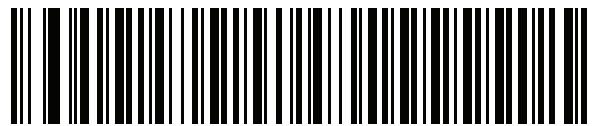
Italian (142)



Japanese (ASCII)



Japanese (SHIFT-JIS) *



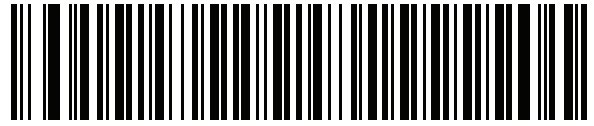
Kazakh



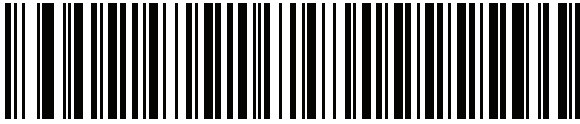
Korean (ASCII)



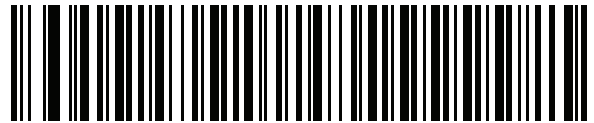
Korean (Hangul) *



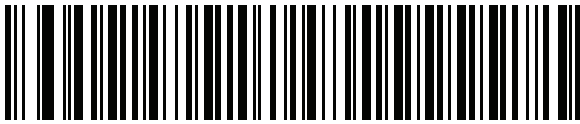
Kyrgyz



Latin American



Latvian



Latvian (QWERTY)



Lithuanian



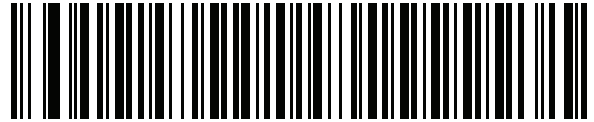
Lithuanian (IBM)



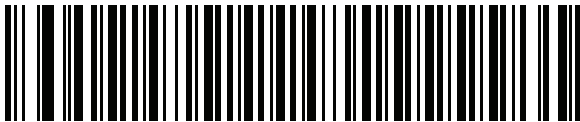
Macedonian (FYROM)



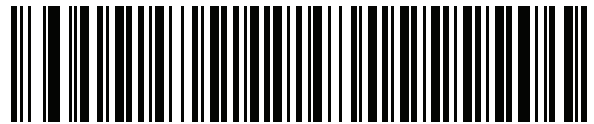
Maltese_47KEY



Mongolian



Norwegian



Polish (214)



Polish (Programmer)



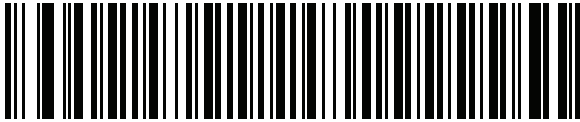
**Portuguese (Brazil)
(Windows XP)**



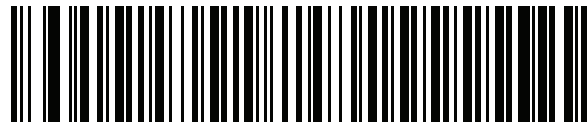
Portuguese (Brazilian ABNT)



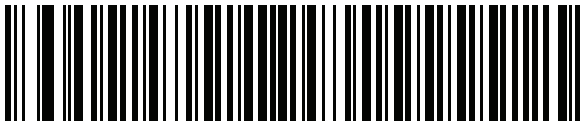
Portuguese (Brazilian ABNT2)



Portuguese (Portugal)



**Romanian
(Windows XP)**



**Romanian (Legacy)
(Win 7 or higher)**



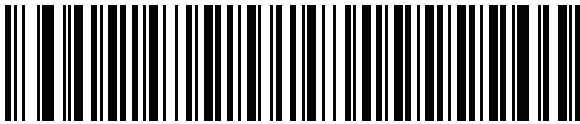
**Romanian (Standard)
(Win 7 or higher)**



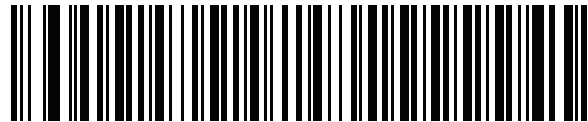
**Romanian (Programmer)
(Win 7 or higher)**



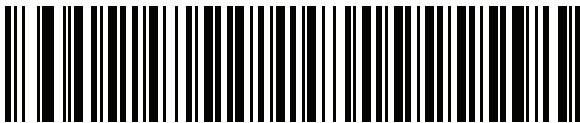
Russian



Russian (Typewriter)



Serbian (Latin)



Serbian (Cyrillic)



Slovak



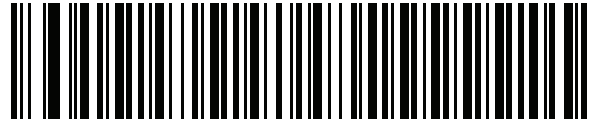
Slovak (QWERTY)



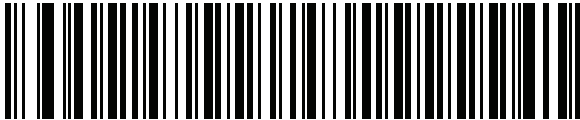
Slovenian



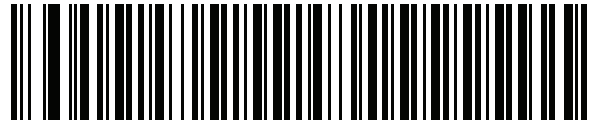
Spanish



Spanish (Variation)



Swedish



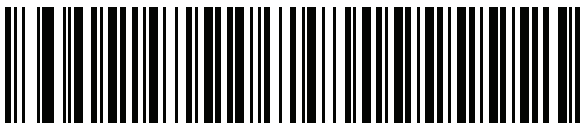
Swiss French



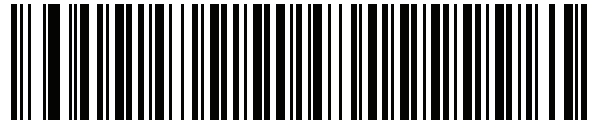
Swiss German



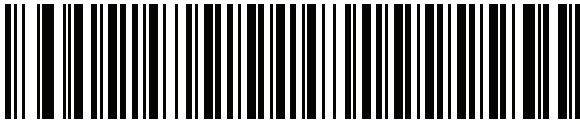
Tatar



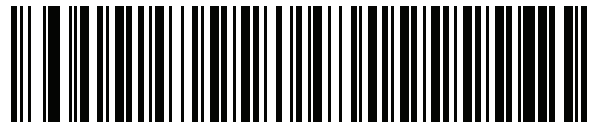
Thai (Kedmanee)



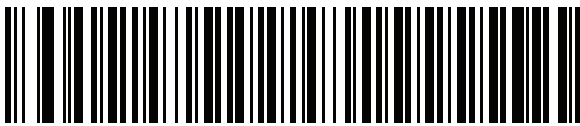
Turkish F



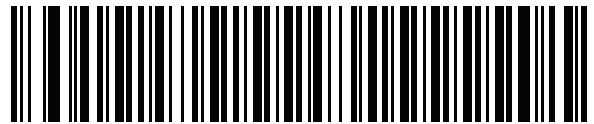
Turkish Q



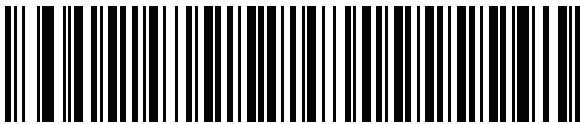
UK English



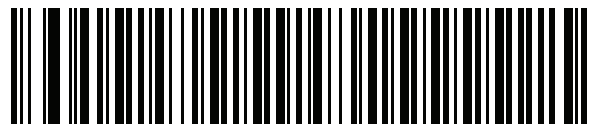
Ukrainian



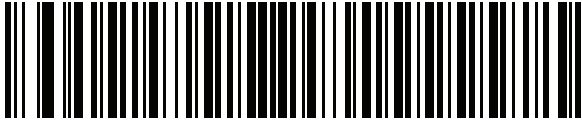
US Dvorak



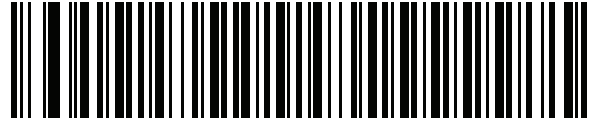
US Dvorak Left



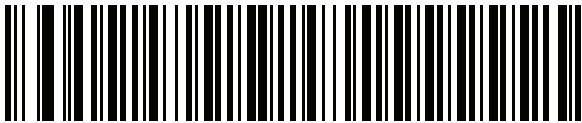
US Dvorak Right



US International



Uzbek



Vietnamese

Country Code Pages

Introduction

This chapter provides barcodes for selecting code pages for the country keyboard type selected in the table below. If the default code page in Table 1 below is appropriate for your selected country keyboard type, you do not need to scan a country code page barcode.



NOTE: ADF rules can also specify a code page based on the symbology and other ADF criteria. Refer to the *Advanced Data Formatting Programmer Guide*.

Country Code Page Defaults

The table below lists the code page default for each country keyboard.

Table 29 Country Code Page Defaults

Country Keyboard	Code Page Default
US English (North American)	Windows 1252
US English (Mac)	Mac CP10000
Albanian	Windows 1250
Arabic 101	Windows 1256
Arabic 102	Windows 1256
Arabic 102 AZERTY	Windows 1256
Azeri Latin	Windows 1254
Azeri Cyrillic	Windows 1251
Belarusian	Windows 1251
Bosnian Latin	Windows 1250
Bosnian Cyrillic	Windows 1251
Bulgarian Latin	Windows 1250
Bulgarian Cyrillic	Windows 1251
Canadian French Win7	Windows 1252
Canadian French (Legacy)	Windows 1252

Table 29 Country Code Page Defaults (Continued)

Country Keyboard	Code Page Default
Canadian Multilingual	Windows 1252
Croatian	Windows 1250
Chinese ASCII	Windows 1252
Chinese (Simplified)	Windows 936, GBK
Chinese (Traditional)	Windows 950, Big5
Czech	Windows 1250
Czech Programmers	Windows 1250
Czech QWERTY	Windows 1250
Danish	Windows 1252
Dutch Netherland	Windows 1252
Estonian	Windows 1257
Faeroese	Windows 1252
Finnish	Windows 1252
French (France)	Windows 1252
French (Canada) 95/98	Windows 1252
French (Canada) 2000/XP	Windows 1252
French International (Belgian French)	Windows 1252
Galician	Windows 1252
German	Windows 1252
Greek Latin	Windows 1252
Greek220 Latin	Windows 1253
Greek319 Latin	Windows 1252
Greek	Windows 1253
Greek220	Windows 1253
Greek319	Windows 1253
Greek Polytonic	Windows 1253
Hebrew Israel	Windows 1255
Hungarian	Windows 1250
Hungarian_101KEY	Windows 1250
Icelandic	Windows 1252
Irish	Windows 1252

Table 29 Country Code Page Defaults (Continued)

Country Keyboard	Code Page Default
Italian	Windows 1252
Italian_142	Windows 1252
Japanese ASCII	Windows 1252
Japanese (Shift-JIS)	Windows 932, Shift-JIS
Kazakh	Windows 1251
Korean ASCII	Windows 1252
Korean (Hangul)	Windows 949, Hangul
Kyrgyz Cyrillic	Windows 1251
Latin America	Windows 1252
Latvian	Windows 1257
Latvian QWERTY	Windows 1257
Lithuanian	Windows 1257
Lithuanian_IBM	Windows 1257
Macedonian -FYROM	Windows 1251
Maltese_47KEY	Windows 1252
Mongolian-Cyrillic	Windows 1251
Norwegian	Windows 1252
Polish_214	Windows 1250
Polish Programmer	Windows 1250
Portuguese Brazil	Windows 1252
Portuguese Brazilian ABNT	Windows 1252
Portuguese Brazilian ABNT2	Windows 1252
Portuguese Portugal	Windows 1252
Romanian	Windows 1250
Romanian Legacy	Windows 1250
Romanian Standard	Windows 1250
Romanian Programmer	Windows 1250
Russian	Windows 1251
Russian Typewriter	Windows 1251
Serbian Latin	Windows 1250
Serbian Cyrillic	Windows 1251

Table 29 Country Code Page Defaults (Continued)

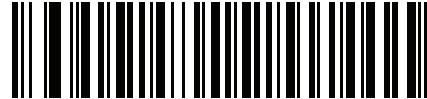
Country Keyboard	Code Page Default
Slovak	Windows 1250
Slovak QWERTY	Windows 1250
Slovenian	Windows 1250
Spanish	Windows 1252
Spanish Variation	Windows 1252
Swedish	Windows 1252
Swiss French	Windows 1252
Swiss German	Windows 1252
Tatar	Windows 1251
Thai-Kedmanee	Windows 874
Turkish F	Windows 1254
Turkish Q	Windows 1254
Ukrainian	Windows 1251
United Kingdom	Windows 1252
United States	Windows 1252
US Dvorak	Windows 1252
US Dvorak Left Hand	Windows 1252
US Dvorak Right Hand	Windows 1252
US International	Windows 1252
Uzbek Cyrillic	Windows 1251
Vietnamese	Windows 1258

Country Code Page Barcodes

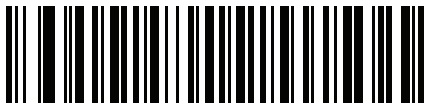
Scan the barcode corresponding to the country keyboard code page.



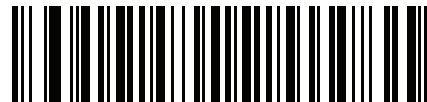
Windows 1250
Latin 2, Central European



Windows 1251
Cyrillic, Slavic



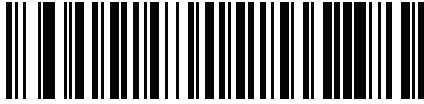
Windows 1252
Latin 1, Western European



Windows 1253
Greek



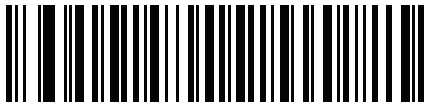
Windows 1254
Latin 5, Turkish



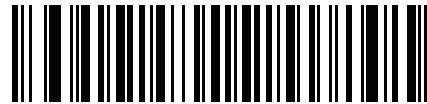
**Windows 1255
Hebrew**



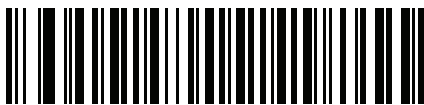
**Windows 1256
Arabic**



**Windows 1257
Baltic**



**Windows 1258
Vietnamese**



**Windows 874
Thai**



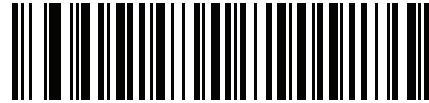
**Windows 20866
Cyrillic KOI8-R**



**Windows 932
Japanese Shift-JIS**



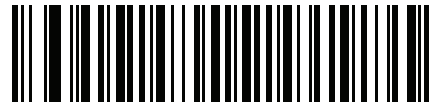
**Windows 936
Simplified Chinese GBK**



**Windows 54936
Simplified Chinese GB18030**



**Windows 949
Korean Hangul**



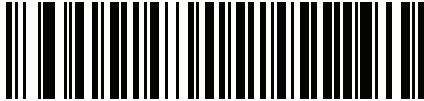
**Windows 950
Traditional Chinese Big5**



**MS-DOS 437
Latin US**



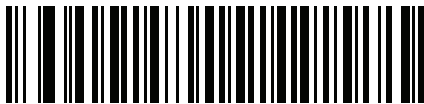
MS-DOS 737
Greek



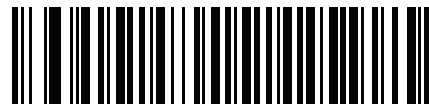
MS-DOS 775
Baltic



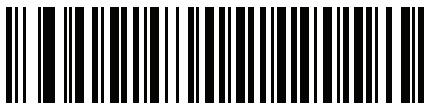
MS-DOS 850
Latin 1



MS-DOS 852
Latin 2



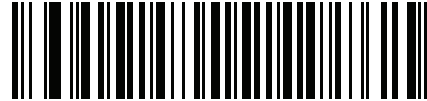
MS-DOS 855
Cyrillic



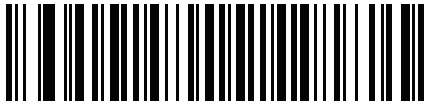
MS-DOS 857
Turkish



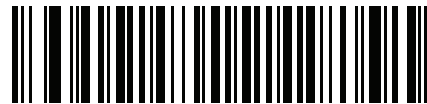
MS-DOS 860
Portuguese



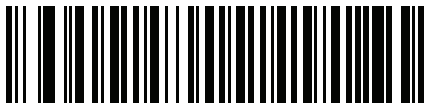
MS-DOS 861
Icelandic



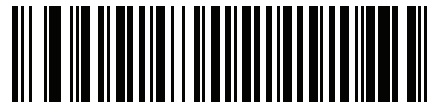
MS-DOS 862
Hebrew



MS-DOS 863
French Canada



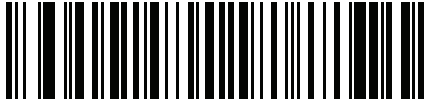
MS-DOS 865
Nordic



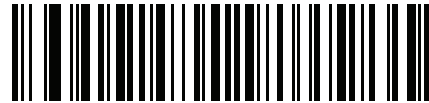
MS-DOS 866
Cyrillic



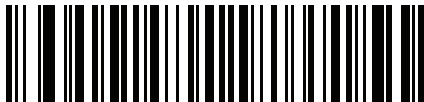
**MS-DOS 869
Greek 2**



**ISO 8859-1
Latin 1, Western European**



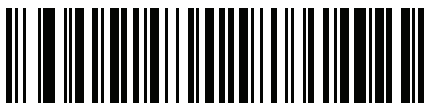
**ISO 8859-2
Latin 2, Central European**



**ISO 8859-3
Latin 3, South European**



**ISO 8859-4
Latin 4, North European**



**ISO 8859-5
Cyrillic**



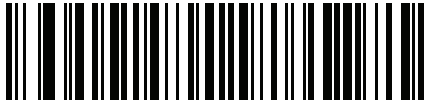
ISO 8859-6
Arabic



ISO 8859-7
Greek



ISO 8859-8
Hebrew



ISO 8859-9
Latin 5, Turkish



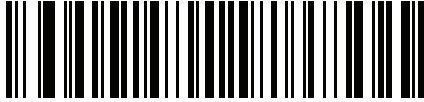
ISO 8859-10
Latin 6, Nordic



ISO 8859-11
Thai



ISO 8859-13
Latin 7, Baltic



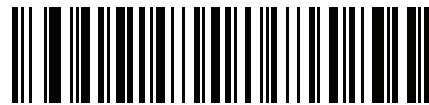
ISO 8859-14
Latin 8, Celtic



ISO 8859-15
Latin 9



ISO 8859-16
Latin 10, South-Eastern European



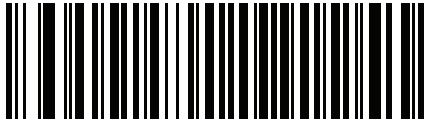
UTF-8



UTF-16LE
UTF-16 Little Endian



UTF-16BE
UTF-16 Big Endian



Mac CP10000
Roman

CJK Decode Control

Introduction

This appendix describes control parameters for CJK (Chinese, Japanese, Korean) barcode decode through USB HID Keyboard Emulation mode.



NOTE: Because ADF does not support CJK character processing, there is no format manipulation for CJK output.

CJK Control Parameters

Unicode Output Control

Parameter # 973

For a Unicode encoded CJK barcode, select one of the following options for unicode output:

- **Universal Output to Unicode and MBCS Application** - This default method applies to Unicode and MBCS expected applications, such as MS Word and Notepad on a Windows host.

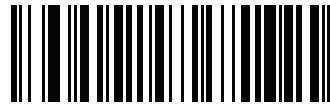


NOTE: To support Unicode universal output, set up the registry table for the Windows host. See [Unicode/CJK Decode Setup with Windows Host on page 381](#).

- **Output to Unicode Application Only** - This method applies only to Unicode expected applications, such as MS Word and WordPad, but not Notepad.



* **Universal Output**
(0)



Unicode Application Only
(1)

CJK Output Method to Windows Host

Parameter # 972

For a national standard encoded CJK barcode, select one of the following options for CJK output to a Windows host:

- **Universal CJK Output** - This is the default universal CJK output method for US English IME or Chinese/Japanese/Korean ASCII IME on a Windows host. This method converts CJK characters to Unicode and emulates the characters when transmitting to the host. Use the [Unicode Output Control](#) parameter to control Unicode output.



NOTE: To support universal CJK output, set up the registry table for the Windows host. See [Unicode/CJK Decode Setup with Windows Host](#) on page 381.

- **Other options for CJK output** - With the following methods, the scanner sends the CJK character hexadecimal internal code (Nei Ma) value to host, or converts the CJK character to Unicode and sends the hexadecimal Unicode value to host. When using these methods, the Windows host must select the corresponding IME to accept the CJK character. See [Unicode/CJK Decode Setup with Windows Host](#) on page 381.
 - **Japanese Unicode Output**
 - **Simplified Chinese GBK Code Output**
 - **Simplified Chinese Unicode Output**
 - **Korean Unicode Code Output**
 - **Traditional Chinese Big5 Code Output** (Windows XP)
 - **Traditional Chinese Big5 Code Output** (Windows 7)
 - **Traditional Chinese Unicode Code Output** (Windows XP)
 - **Traditional Chinese Unicode Code Output** (Windows 7)



NOTE: The Unicode emulate output method depends on the host system (Windows XP or Windows 7).



* Universal CJK Output
(0)



Japanese Unicode Output
(34)

(for Japanese Unicode Output, select Simplified Chinese Unicode IME on the Windows host)

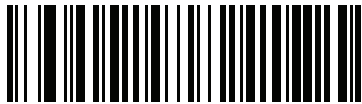
CJK Output Method to Windows Host (continued)



**Chinese (Simplified) GBK Output
(1)**

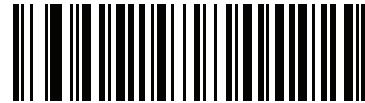


**Chinese (Simplified) Unicode Output
(2)**

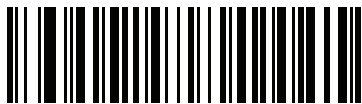


**Korean Unicode Output
(50)**

(for Korean Unicode Output, select Simplified Chinese Unicode IME on the Windows host)



**Chinese (Traditional) Big5 Output (Windows XP)
(17)**



**Chinese (Traditional) Big5 Output (Windows 7)
(19)**



**Chinese (Traditional) Unicode Output (Windows XP)
(18)**



**Chinese (Traditional) Unicode Output (Windows 7)
(20)**

Non-CJK UTF Barcode Output

Parameter # 960

Some country keyboard type layouts contain characters that do not exist in the default code page (see [Country Keyboard Type Missing Characters on page 380](#)). Although the default code page can not encode these characters in a barcode, they can be encoded in the UTF-8 barcode. Scan this parameter barcode to output the Unicode values by emulation mode.



NOTE: Use this special country keyboard type to decode the non-CJK UTF-8 barcode. After decoding, re-configure the imager to use the original country keyboard type.

Use US English IME on Windows. See [Unicode Output Control on page 376](#).



Non-CJK UTF-8 Emulation Output

Country Keyboard Type Missing Characters

Country keyboard type: **Tatar, Uzbek, Mongolian, Kyrgyz, Kazakh and Azeri**

Default code page: CP1251

Missing characters:

ƒ	F
х	X
қ	Q
h	H
ө	Ө
ә	Ә
Ү	Y
Һ	Ғ
Ж	Ж
Ғ	
Һ	Ғ
Ү	Y
қ	Q
ч	Ч
к	К

Country keyboard type: **Romanian (Standard)**

Default code page: CP1250

Missing characters:

ș	Ș
ț	Ț

Country keyboard type: **Portuguese-Brazilian (ABNT), Portuguese-Brazilian (ABNT2)**

Default code page: CP1252

Missing character: **Ç**

Country keyboard type: **Azeri-Latin**

Default code page: CP1254

Missing characters: ə, Ə

Unicode/CJK Decode Setup with Windows Host

This section describes how to set up CJK decode with a Windows host.

Setting Up the Windows Registry Table for Unicode Universal Output

To support the Unicode universal output method, set up the Windows host registry table as follows:

1. Select **Start > Run > regedt32** to start the registry editor.
2. Under **HKEY_Current_User\Control Panel\Input Method**, set **EnableHexNumpad** to **1** as follows:

```
[HKEY_CURRENT_USER\Control Panel\Input Method]
```

```
"EnableHexNumpad"="1"
```

If this key does not exist, add it as type **REG_SZ** (string value).

3. Reboot the computer to implement the registry change.

Adding CJK IME on Windows

To add the desired CJK input language:

1. Click **Start > Control Panel**.
2. If the Control Panel opens in category view, select **Switch to Classic View** in the top left corner.
3. Select **Regional and Language Options**.
4. Click the **Language** tab.
5. Under **Supplemental Language Support**, select the **Install Files for East Asian Languages** check box if not already selected, and click **Apply**. This may require a Windows installation CD to install the required files. This step ensures that the East Asian Languages (CJK) are available.
6. Under **Text Services and Input Language**, click **Details**.
7. Under **Installed Services**, click **Add**.
8. In the **Add Input Language** dialog box, choose the CJK input language and keyboard layout or Input Method Editor (IME) to add.
9. Click **OK** twice. The language indicator appears in the system tray (at bottom right corner of the desktop by default). To switch between input languages (keyboard languages) select the language indicator in the system tray.
10. Select the language indicator in the system tray to select the desired country keyboard type.
11. Verify that the characters displayed on each country's keyboard appear.

Selecting the Simplified Chinese Input Method on the Host

To select the Simplified Chinese input method:

- Select Unicode/GBK input on Windows XP: **Chinese (Simplified) - NeiMa**, then click the input bar to select **Unicode** or **GBK NeiMa** input.

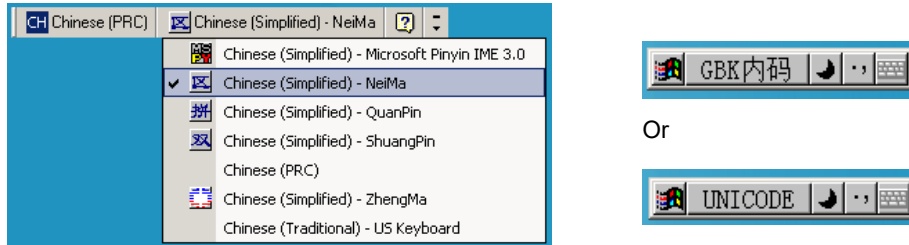


Figure 28 Unicode/GBK Input on Windows XP

- Select Unicode/GBK input on Windows 7: **Chinese (Simplified) - Microsoft Pinyin New Experience Input Style**, then select **Tool Menu > Secondary Inputs > Unicode Input** or **GB Code Input**.

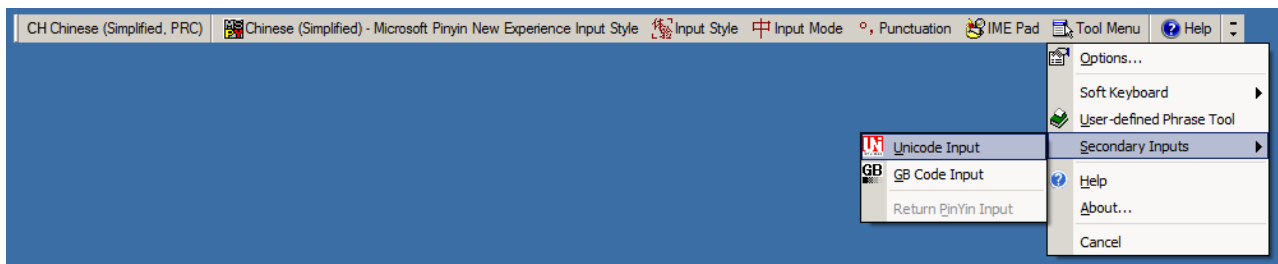


Figure 29 Unicode/GBK Input on Windows 7

Selecting the Traditional Chinese Input Method on the Host

To select the Traditional Chinese input method:

Figure 30 Select Unicode input on Windows XP: **Chinese (Traditional) - Unicode**

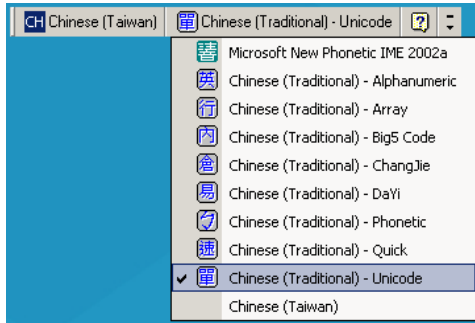


Figure 31 Unicode Input on Windows XP

- Select Big5 input on Windows XP: **Chinese (Traditional) - Big5 Code**

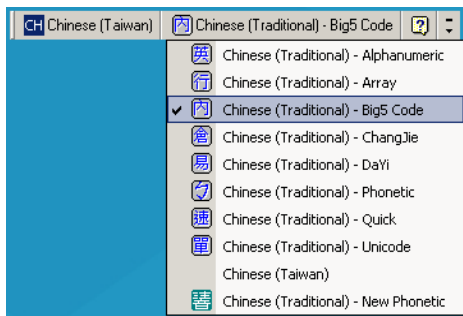


Figure 32 Big5 input on Windows XP

- Select Unicode/Big5 input on Windows 7: **Chinese (Traditional) - New Quick**. This option support both Unicode and Big5 input.



Figure 33 Unicode/Big5 input on Windows 7

Programming Reference

Symbol Code Identifiers

Table 30 Symbol Code Characters

Code Character	Code Type
A	UPC-A, UPC-E, UPC-E1, EAN-8, EAN-13
B	Code 39, Code 32
C	Codabar
D	Code 128, ISBT 128, ISBT 128 Concatenated
E	Code 93
F	Interleaved 2 of 5
G	Discrete 2 of 5, or Discrete 2 of 5 IATA
H	Code 11
J	MSI
K	GS1-128
L	Bookland EAN
M	Trioptic Code 39
N	Coupon Code
R	GS1 DataBar Family
S	Matrix 2 of 5
T	UCC Composite, TLC 39
U	Chinese 2 of 5
V	Korean 3 of 5
X	ISSN EAN, PDF417, Macro PDF417, Micro PDF417
z	Aztec, Aztec Rune
P00	Data Matrix

Table 30 Symbol Code Characters (Continued)

Code Character	Code Type
P01	QR Code, MicroQR
P02	Maxicode
P03	US Postnet
P04	US Planet
P05	Japan Postal
P06	UK Postal
P08	Netherlands KIX Code
P09	Australia Post
P0A	USPS 4CB/One Code/Intelligent Mail
P0B	UPU FICS Postal
P0C	Mailmark
P0H	Han Xin
P0G	GS1 Data Matrix
P0Q	GS1 QR
P0X	Signature Capture

AIM Code Identifiers

Each AIM Code Identifier contains the three-character string **Jcm** where:

- J = Flag Character (ASCII 93)
- c = Aim Code Character (see Table 2 below)
- m = Modifier Character (see Table 32)

Table 31 Aim Code Characters

Code Character	Code Type
A	Code 39, Code 39 Full ASCII, Code 32
C	Code 128, ISBT 128, ISBT 128 Concatenated, GS1-128, Coupon (Code 128 portion)
d	Data Matrix, GS1-DM
E	UPC/EAN, Coupon (UPC portion)
e	GS1 DataBar Family
F	Codabar
G	Code 93
H	Code 11
h	Han Xin
I	Interleaved 2 of 5
L	PDF417, Macro PDF417, Micro PDF417
L2	TLC 39
M	MSI
Q	QR Code, MicroQR, GS1-QR
S	Discrete 2 of 5, IATA 2 of 5
U	Maxicode
z	Aztec, Aztec Rune
X	Bookland EAN, ISSN EAN, Trioptic Code 39, Chinese 2 of 5, Matrix 2 of 5, Korean 3 of 5, US Postnet, US Planet, UK Postal, Japan Postal, Australia Post, Netherlands KIX Code, USPS 4CB/One Code/ Intelligent Mail, UPU FICS Postal, Signature Capture, Mailmark

The modifier character is the sum of the applicable option values based on [Table 32](#).

Table 32 Modifier Characters

Code Type	Option Value	Option
Code 39	0	No check character or Full ASCII processing.
	1	Reader has checked one check character.
	3	Reader has checked and stripped check character.
	4	Reader has performed Full ASCII character conversion.
	5	Reader has performed Full ASCII character conversion and checked one check character.
	7	Reader has performed Full ASCII character conversion and checked and stripped check character.
	Example: A Full ASCII barcode with check character W, A+I+MI+DW , is transmitted as J A7AIMID where 7 = (3+4).	
Trioptic Code 39	0	No option specified at this time. Always transmit 0.
	Example: A Trioptic barcode 412356 is transmitted as J X0412356	
Mailmark	0	No option specified at this time. Always transmit 0.
Code 128	0	Standard data packet, no Function code 1 in first symbol position.
	1	Function code 1 in first symbol character position.
	2	Function code 1 in second symbol character position.
	Example: A Code (EAN) 128 barcode with Function 1 character ^{FNC1} in the first position, AIMID is transmitted as J C1AIMID	
I 2 of 5	0	No check digit processing.
	1	Reader has validated check digit.
	3	Reader has validated and stripped check digit.
	Example: An I 2 of 5 barcode without check digit, 4123, is transmitted as J I04123	
Codabar	0	No check digit processing.
	1	Reader has checked check digit.
	3	Reader has stripped check digit before transmission.
	Example: A Codabar barcode without check digit, 4123, is transmitted as J F04123	
Code 93	0	No options specified at this time. Always transmit 0.
	Example: A Code 93 barcode 012345678905 is transmitted as J G0012345678905	
MSI	0	Check digits are sent.
	1	No check digit is sent.
	Example: An MSI barcode 4123, with a single check digit checked, is transmitted as J M14123	

Table 32 Modifier Characters (Continued)

Code Type	Option Value	Option
D 2 of 5	0	No options specified at this time. Always transmit 0.
	Example: A D 2 of 5 barcode 4123, is transmitted as JS04123	
UPC/EAN	0	Standard data packet in full EAN format, i.e. 13 digits for UPC-A, UPC-E, and EAN-13 (not including supplemental data).
	1	Two digit supplemental data only.
	2	Five digit supplemental data only.
	3	Combined data packet comprising 13 digits from EAN-13, UPC-A or UPC-E symbol and 2 or 5 digits from supplemental symbol.
	4	EAN-8 data packet.
	Example: A UPC-A barcode 012345678905 is transmitted as JE00012345678905	
Bookland EAN	0	No options specified at this time. Always transmit 0.
	Example: A Bookland EAN barcode 123456789X is transmitted as JX0123456789X	
ISSN EAN	0	No options specified at this time. Always transmit 0.
	Example: An ISSN EAN barcode 123456789X is transmitted as JX0123456789X	
Code 11	0	Single check digit
	1	Two check digits
	3	Check characters validated but not transmitted.
GS1 DataBar Family		No option specified at this time. Always transmit 0. GS1 DataBar-14 and GS1 DataBar Limited transmit with an Application Identifier "01". Note: In GS1-128 emulation mode, GS1 DataBar is transmitted using Code 128 rules (i.e., JC1).
	Example: A GS1 DataBar-14 barcode 0110012345678902 is transmitted as Je00110012345678902 .	
EAN.UCC Composites (GS1 DataBar, GS1-128, 2D portion of UPC composite)		Native mode transmission. Note: UPC portion of composite is transmitted using UPC rules.
	0	Standard data packet.
	1	Data packet containing the data following an encoded symbol separator character.
	2	Data packet containing the data following an escape mechanism character. The data packet does not support the ECI protocol.
	3	Data packet containing the data following an escape mechanism character. The data packet supports the ECI protocol.
		GS1-128 emulation Note: UPC portion of composite is transmitted using UPC rules.
1	Data packet is a GS1-128 symbol (i.e., data is preceded with JC1).	

Table 32 Modifier Characters (Continued)

Code Type	Option Value	Option
PDF417, Micro PDF417	0	Reader set to conform to protocol defined in 1994 PDF417 symbology specifications. Note: When this option is transmitted, the receiver cannot reliably determine whether ECIs have been invoked or whether data byte 92 _{DEC} has been doubled in transmission.
	1	Reader set to follow the ECI protocol (Extended Channel Interpretation). All data characters 92 _{DEC} are doubled.
	2	Reader set for Basic Channel operation (no escape character transmission protocol). Data characters 92 _{DEC} are not doubled. Note: When decoders are set to this mode, unbuffered Macro symbols and symbols requiring the decoder to convey ECI escape sequences cannot be transmitted.
	3	The barcode contains a GS1-128 symbol, and the first codeword is 903-907, 912, 914, 915.
	4	The barcode contains a GS1-128 symbol, and the first codeword is in the range 908-909.
	5	The barcode contains a GS1-128 symbol, and the first codeword is in the range 910-911.
	Example: A PDF417 barcode ABCD, with no transmission protocol enabled, is transmitted as]L2ABCD.	
Data Matrix	0	ECC 000-140, not supported.
	1	ECC 200.
	2	ECC 200, FNC1 in first or fifth position.
	3	ECC 200, FNC1 in second or sixth position.
	4	ECC 200, ECI protocol implemented.
	5	ECC 200, FNC1 in first or fifth position, ECI protocol implemented.
	6	ECC 200, FNC1 in second or sixth position, ECI protocol implemented.
GS1 Data Matrix	2	ECC 200, FNC1 in first or fifth position.
MaxiCode	0	Symbol in Mode 4 or 5.
	1	Symbol in Mode 2 or 3.
	2	Symbol in Mode 4 or 5, ECI protocol implemented.
	3	Symbol in Mode 2 or 3, ECI protocol implemented in secondary message.

Table 32 Modifier Characters (Continued)

Code Type	Option Value	Option
QR Code	0	Model 1 symbol.
	1	Model 2 / MicroQR symbol, ECI protocol not implemented.
	2	Model 2 symbol, ECI protocol implemented.
	3	Model 2 symbol, ECI protocol not implemented, FNC1 implied in first position.
	4	Model 2 symbol, ECI protocol implemented, FNC1 implied in first position.
	5	Model 2 symbol, ECI protocol not implemented, FNC1 implied in second position.
	6	Model 2 symbol, ECI protocol implemented, FNC1 implied in second position.
GS1 QR	3	Model 2 symbol, ECI protocol not implemented, FNC1 implied in first position.
Aztec	0	Aztec symbol.
	C	Aztec Rune symbol.
Han Xin	0	Generic data, no special features are set. The transmitted data does not follow the AIM ECI protocol.
	1	ECI protocol enabled. There is at least one ECI mode encoded. Transmitted data must follow the AIM ECI protocol.

Sample Barcodes

Code 39



UPC/EAN

UPC-A, 100%



EAN-13, 100%



Code 128



Interleaved 2 of 5



GS1 DataBar-14

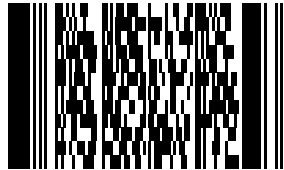


NOTE: DataBar-14 must be enabled to read the barcode below (see [GS1 DataBar on page 214](#)).



7612341562341

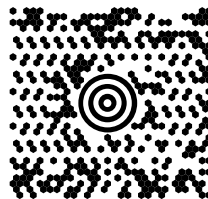
PDF417



Data Matrix



Maxicode



QR Code



US Postnet



UK Postal



Alphanumeric Barcodes

Alphanumeric Barcodes



Space



#



\$



%

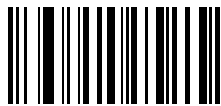
Alphanumeric Keyboard (continued)



*



+



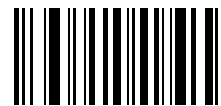
-



.



/



!

Alphanumeric Keyboard (continued)



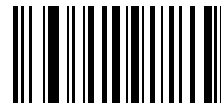
“



&



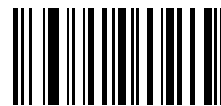
’



(



)

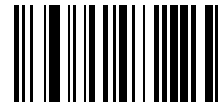


:

Alphanumeric Keyboard (continued)



;



<



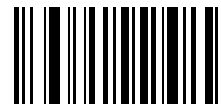
=



>



?

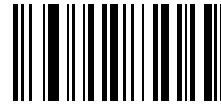


@

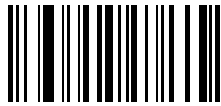
Alphanumeric Keyboard (continued)



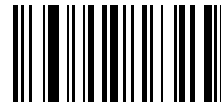
[



\



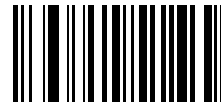
]



^



-



,

Alphanumeric Keyboard (continued)



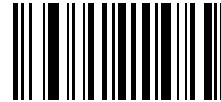
NOTE: Do not confuse the barcodes that follow with those on the numeric keypad.



1



0



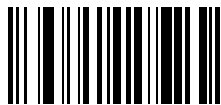
2



3



4

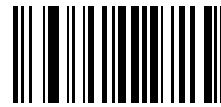


5

Alphanumeric Keyboard (continued)



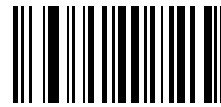
6



7



8



9



End of Message



Cancel

Alphanumeric Keyboard (continued)



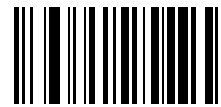
A



B



C



D



E

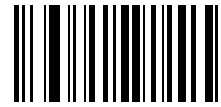


F

Alphanumeric Keyboard (continued)



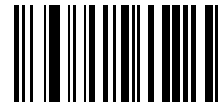
G



H



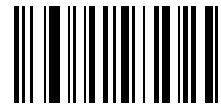
I



J



K

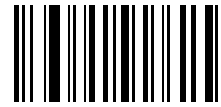


L

Alphanumeric Keyboard (continued)



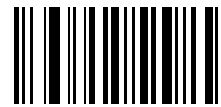
M



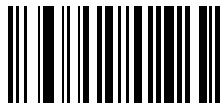
N



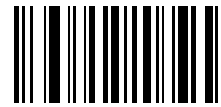
O



P



Q

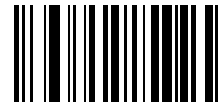


R

Alphanumeric Keyboard (continued)



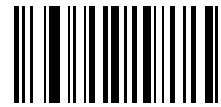
S



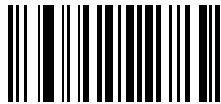
T



U



V



W



X

Alphanumeric Keyboard (continued)



Y



Z



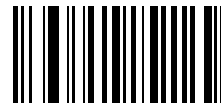
a



b



c

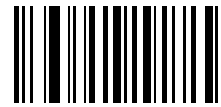


d

Alphanumeric Keyboard (continued)



e



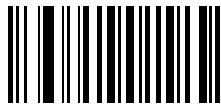
f



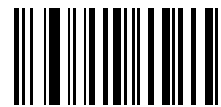
g



h



i

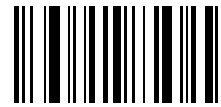


j

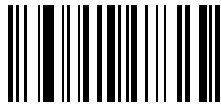
Alphanumeric Keyboard (continued)



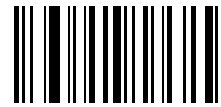
k



l



m



n



o

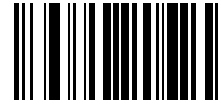


p

Alphanumeric Keyboard (continued)



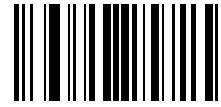
q



r



s



t



u

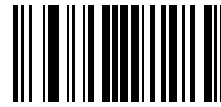


v

Alphanumeric Keyboard (continued)



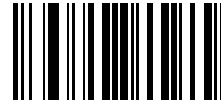
w



x



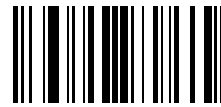
y



z

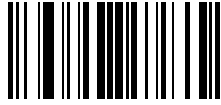


{



|

Alphanumeric Keyboard (continued)



}

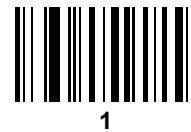


~

Numeric Barcodes

Numeric Barcodes

For parameters requiring specific numeric values, scan the appropriately numbered barcode(s).



Numeric Barcodes (continued)



Cancel

To correct an error or change a selection, scan the barcode below.



ASCII Character Sets

Table 33 ASCII Character Set

ASCII Value	Full ASCII Code 39 Encode Char	Keystroke
1000	%U	CTRL 2
1001	\$A	CTRL A
1002	\$B	CTRL B
1003	\$C	CTRL C
1004	\$D	CTRL D
1005	\$E	CTRL E
1006	\$F	CTRL F
1007	\$G	CTRL G
1008	\$H	CTRL H/ BACKSPACE ¹
1009	\$I	CTRL I/ HORIZONTAL TAB ¹
1010	\$J	CTRL J
1011	\$K	CTRL K
1012	\$L	CTRL L
1013	\$M	CTRL M/ ENTER ¹
1014	\$N	CTRL N
1015	\$O	CTRL O
1016	\$P	CTRL P
1017	\$Q	CTRL Q
1018	\$R	CTRL R
1019	\$S	CTRL S

The keystroke in bold transmits only if you enabled Function Key Mapping. Otherwise, the unbold keystroke transmits.

Table 33 ASCII Character Set (Continued)

ASCII Value	Full ASCII Code 39 Encode Char	Keystroke
1020	\$T	CTRL T
1021	\$U	CTRL U
1022	\$V	CTRL V
1023	\$W	CTRL W
1024	\$X	CTRL X
1025	\$Y	CTRL Y
1026	\$Z	CTRL Z
1027	%A	CTRL [
1028	%B	CTRL \
1029	%C	CTRL]
1030	%D	CTRL 6
1031	%E	CTRL -
1032	Space	Space
1033	/A	!
1034	/B	"
1035	/C	#
1036	/D	\$
1037	/E	%
1038	/F	&
1039	/G	'
1040	/H	(
1041	/I)
1042	/J	*
1043	/K	+
1044	/L	,
1045	-	-
1046	.	.
1047	/o	/
1048	0	0

The keystroke in bold transmits only if you enabled Function Key Mapping. Otherwise, the unbold keystroke transmits.

Table 33 ASCII Character Set (Continued)

ASCII Value	Full ASCII Code 39 Encode Char	Keystroke
1049	1	1
1050	2	2
1051	3	3
1052	4	4
1053	5	5
1054	6	6
1055	7	7
1056	8	8
1057	9	9
1058	/Z	:
1059	%F	;
1060	%G	<
1061	%H	=
1062	%I	>
1063	%J	?
1064	%V	@
1065	A	A
1066	B	B
1067	C	C
1068	D	D
1069	E	E
1070	F	F
1071	G	G
1072	H	H
1073	I	I
1074	J	J
1075	K	K
1076	L	L
1077	M	M

The keystroke in bold transmits only if you enabled Function Key Mapping. Otherwise, the unbold keystroke transmits.

Table 33 ASCII Character Set (Continued)

ASCII Value	Full ASCII Code 39 Encode Char	Keystroke
1078	N	N
1079	O	O
1080	P	P
1081	Q	Q
1082	R	R
1083	S	S
1084	T	T
1085	U	U
1086	V	V
1087	W	W
1088	X	X
1089	Y	Y
1090	Z	Z
1091	%K	[
1092	%L	\
1093	%M]
1094	%N	^
1095	%O	_
1096	%W	'
1097	+A	a
1098	+B	b
1099	+C	c
1100	+D	d
1101	+E	e
1102	+F	f
1103	+G	g
1104	+H	h
1105	+I	i
1106	+J	j

The keystroke in bold transmits only if you enabled Function Key Mapping. Otherwise, the unbold keystroke transmits.

Table 33 ASCII Character Set (Continued)

ASCII Value	Full ASCII Code 39 Encode Char	Keystroke
1107	+K	k
1108	+L	l
1109	+M	m
1110	+N	n
1111	+O	o
1112	+P	p
1113	+Q	q
1114	+R	r
1115	+S	s
1116	+T	t
1117	+U	u
1118	+V	v
1119	+W	w
1120	+X	x
1121	+Y	y
1122	+Z	z
1123	%P	{
1124	%Q	
1125	%R	}
1126	%S	~
1127		Undefined

The keystroke in bold transmits only if you enabled Function Key Mapping. Otherwise, the unbold keystroke transmits.

Table 34 ALT Key Standard Default Tables

ALT Keys	Keystroke
2050	ALT 2
2054	ALT 6
2064	ALT @
2065	ALT A
2066	ALT B
2067	ALT C

Table 34 ALT Key Standard Default Tables (Continued)

ALT Keys	Keystroke
2068	ALT D
2069	ALT E
2070	ALT F
2071	ALT G
2072	ALT H
2073	ALT I
2074	ALT J
2075	ALT K
2076	ALT L
2077	ALT M
2078	ALT N
2079	ALT O
2080	ALT P
2081	ALT Q
2082	ALT R
2083	ALT S
2084	ALT T
2085	ALT U
2086	ALT V
2087	ALT W
2088	ALT X
2089	ALT Y
2090	ALT Z
2091	ALT [
2092	ALT \
2093	ALT]

Table 35 USB GUI Key Character Set

GUI Key	Keystroke
3000	Right Control Key
3001	PA 1
3002	PA 2
3003	CMD 1
3004	CMD 2
3005	CMD 3
3006	CMD 4
3007	CMD 5
3008	CMD 6
3009	CMD 7
3010	CMD 8
3011	CMD 9
3012	CMD 10
3013	CMD 11
3014	CMD 12
3015	CMD 13
3016	CMD 14
3048	GUI 0
3049	GUI 1
3050	GUI 2
3051	GUI 3
3052	GUI 4
3053	GUI 5
3054	GUI 6
3055	GUI 7
3056	GUI 8
3057	GUI 9
3065	GUI A

Note: GUI Shift Keys - The Apple™ iMac keyboard has an apple key on either side of the space bar. Windows-based systems have a GUI key to the left of the left ALT key, and to the right of the right ALT key.

Table 35 USB GUI Key Character Set (Continued)

GUI Key	Keystroke
3066	GUI B
3067	GUI C
3068	GUI D
3069	GUI E
3070	GUI F
3071	GUI G
3072	GUI H
3073	GUI I
3074	GUI J
3075	GUI K
3076	GUI L
3077	GUI M
3078	GUI N
3079	GUI O
3080	GUI P
3081	GUI Q
3082	GUI R
3083	GUI S
3084	GUI T
3085	GUI U
3086	GUI V
3087	GUI W
3088	GUI X
3089	GUI Y
3090	GUI Z

Note: GUI Shift Keys - The Apple™ iMac keyboard has an apple key on either side of the space bar. Windows-based systems have a GUI key to the left of the left ALT key, and to the right of the right ALT key.

Table 36 PF Key Standard Default Table

PF Keys	Keystroke
4001	PF 1
4002	PF 2
4003	PF 3
4004	PF 4
4005	PF 5
4006	PF 6
4007	PF 7
4008	PF 8
4009	PF 9
4010	PF 10
4011	PF 11
4012	PF 12
4013	PF 13
4014	PF 14
4015	PF 15
4016	PF 16

Table 37 F key Standard Default Table

F Keys	Keystroke
5001	F 1
5002	F 2
5003	F 3
5004	F 4
5005	F 5
5006	F 6
5007	F 7
5008	F 8
5009	F 9
5010	F 10
5011	F 11
5012	F 12
5013	F 13
5014	F 14
5015	F 15
5016	F 16
5017	F 17
5018	F 18
5019	F 19
5020	F 20
5021	F 21
5022	F 22
5023	F 23
5024	F 24

Table 38 Numeric Key Standard Default Table

Numeric Keypad	Keystroke
6042	*
6043	+
6044	Undefined
6045	-
6046	.
6047	/
6048	0
6049	1
6050	2
6051	3
6052	4
6053	5
6054	6
6055	7
6056	8
6057	9
6058	Enter
6059	Num Lock

Table 39 Extended Keypad Standard Default Table

Extended Keypad	Keystroke
7001	Break
7002	Delete
7003	Pg Up
7004	End
7005	Pg Dn
7006	Pause
7007	Scroll Lock
7008	Backspace
7009	Tab
7010	Print Screen
7011	Insert
7012	Home
7013	Enter
7014	Escape
7015	Up Arrow
7016	Dn Arrow
7017	Left Arrow
7018	Right Arrow

Communication Protocol Functionality

Functionality Supported via Communication (Cable) Interface

Table 40 lists supported scanner functionality by communication protocol.

Table 40 Communication Interface Functionality

Communication Interfaces	Functionality		
	Data Transmission	Remote Management	Image and Video Transmission
USB			
HID Keyboard Emulation	Supported	Not Available	Not Available
CDC COM Port Emulation	Supported	Not Available	Not Available
SSI over CDC COM Port Emulation	Supported	Supported	Supported
IBM Table-top USB	Supported	Supported	Not Available
IBM Hand-held USB	Supported	Supported	Not Available
USB OPOS Hand-held	Supported	Supported	Not Available
Symbol Native API (SNAPI) without Imaging Interface	Supported	Supported	Not Available
Symbol Native API (SNAPI) with Imaging Interface	Supported	Supported	Supported
Toshiba TEC	Not Available	Not Available	Not Available

Signature Capture Code

Introduction

CapCode, a signature capture code, is a special pattern that encloses a signature area on a document and allows a scanner to capture a signature.

There are several accepted patterns that allow automatic identification of different signatures on the same form. For example, on the federal tax return 1040 form there are three signature areas, one each for two joint filers, and one for a professional preparer. By using different patterns, a program can correctly identify all three, so they can be captured in any sequence and still be identified correctly.

Code Structure

Signature Capture Area

A CapCode is printed as two identical patterns on either side of a signature capture box, as shown in Figure 1 below. Each pattern extends the full height of the signature capture box.

The box is optional, so you can omit it, replace it with a single baseline, or print a baseline with an "X" on top of it towards the left, as is customarily done in the US to indicate a request for signature. However, if an "X" or other markings are added in the signature box area, these are captured with the signature.



Figure 34 CapCode

CapCode Pattern Structure

A CapCode pattern structure consists of a start pattern followed by a separator space, a signature capture box, a second separator space, and then a stop pattern. Assuming that X is the dimension of the thinnest element, the start and stop patterns each contains $9X$ total width in 4 bars and 3 spaces. A $7X$ quiet zone is required to the left and to the right of the CapCode pattern.

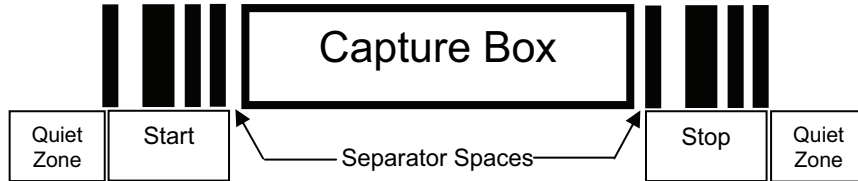


Figure 35 CapCode Structure

The separator spaces on either side of the signature capture box can be between $1X$ and $3X$ wide.

Start / Stop Patterns

Table 1 below lists the accepted start / stop patterns. The bar and space widths are expressed as multiples of X . You must use the same pattern on either side of a signature capture box. The type value is reported with the captured signature to indicate the purpose of the signature captured.

Table 41 Start / Stop Pattern Definitions

Bar/Space Patterns							Type
B	S	B	S	B	S	B	
1	1	2	2	1	1	1	2
1	2	2	1	1	1	1	5
2	1	1	2	1	1	1	7
2	2	1	1	1	1	1	8
3	1	1	1	1	1	1	9

Table 2 below lists selectable parameters used to generate the image of the captured signature.

Table 42 User Defined CapCode Parameters

Parameter	Defined
Width	Number of pixels
Height	Number of pixels
Format	JPEG, BMP, TIFF
JPEG quality	1 (most compression) to 100 (best quality)
Bits Per Pixel (not applicable to JPEG format)	1 (2 levels)
	4 (16 levels)
	8 (256 levels)

BMP format does not use compression, JPEG and TIFF formats do.

Dimensions

The size of the signature capture box is determined by the height and separation of the start and stop patterns. The line width of the signature capture box is insignificant.

The thinnest element width, referred to here as X, is nominally 10 mils (1 mil = 0.0254 mm). Select this as an exact multiple of the pixel pitch of the printer used. For example, when using a 203 DPI (dots-per-inch) printer and printing 2 dots per module, the resulting X dimension is 9.85 mils.

Data Format

The decoder output is formatted according to Table 3 below. Zebra decoders allow different user options to output or inhibit barcode type. Selecting "Symbol ID" as the barcode type for output identifies the CapCode with letter "i".

Table 43 Data Format

File Format (1 byte)	Type (1 byte)	Image Size (4 bytes, BIG Endian)	Image Data
JPEG - 1 BMP - 3 TIFF - 4	See Table 41 , last column		(Same bytes as in a data file)

Additional Capabilities

Regardless of how the signature is captured, the output signature image is de-skewed and right-side up.

A scanner that captures signatures automatically determines whether it is scanning a signature or a barcode. You can disable the signature capturing capability in a decoder.

Signature Boxes

The figure below illustrates the five acceptable signature boxes.

Figure 36 Acceptable Signature Boxes

Type 2:



Type 5:



Type 7:



Type 8:



Type 9:



Non-Parameter Attributes

Introduction

This appendix defines non-parameter attributes.

Attributes

Model Number

Attribute #533

Model number of the scanner. This electronic output matches the printout on the physical device label, for example **MS4717-LU0C0R**.

Type	S
Size (Bytes)	18
User Mode Access	R
Values	Variable

Serial Number

Attribute #534

Unique serial number assigned in the manufacturing facility. This electronic output matches the printout on the physical device label, for example **M1J26F45V**.

Type	S
Size (Bytes)	16
User Mode Access	R
Values	Variable

Date of Manufacture

Attribute #535

Date of device manufacture assigned in the manufacturing facility. This electronic output matches the printout on the physical device label, for example **30APR20** (which reads the 30th of April 2020).

Type	S
Size (Bytes)	7
User Mode Access	R

Values Variable

Date of First Programming

Attribute #614

Date of first electronic programming represents the first time settings were electronically loaded to the scanner either by 123Scan or via SMS, for example **18MAY20** (which reads the 18th of May 2020).

Type S
Size (Bytes) 7
User Mode Access R
Values Variable

Configuration Filename

Attribute #616

The name assigned to the configuration settings loaded electronically to the device either by 123Scan or via SMS.



NOTE: Scanning the **Set Defaults** barcode automatically changes the configuration filename to *factory defaults*.

To indicate the configuration settings loaded to the device were changed, the configuration filename changes to *Modified* upon scanning any parameter barcode.

Type S
Size (Bytes) 17
User Mode Access RW
Values Variable

Beeper/LED**Attribute #6000**

Activates the beeper and/or LED.

Type	X
Size (Bytes)	N/A
User Mode Access	W

Values:

Beep / LED Action	Value
1 high short beep	0
2 high short beeps	1
3 high short beeps	2
4 high short beeps	3
5 high short beeps	4
1 low short beep	5
2 low short beeps	6
3 low short beeps	7
4 low short beeps	8
5 low short beeps	9
1 high long beep	10
2 high long beeps	11
3 high long beeps	12
4 high long beeps	13
5 high long beeps	14
1 low long beep	15
2 low long beeps	16
3 low long beeps	17
4 low long beeps	18
5 low long beeps	19
Fast warble beep	20
Slow warble beep	21
High-low beep	22
Low-high beep	23
High-low-high beep	24
Low-high-low beep	25
High-high-low-low beep	26
Green LED off	42
Green LED on	43
Red LED on	47
Red LED off	48

Parameter Defaults

Attribute #6001

This attribute restores all parameters to their factory defaults.

Type	X
Size (Bytes)	N/A
User Mode Access	W
Values	0 = Restore Defaults 1 = Restore Factory Defaults 2 = Write Custom Defaults

Reboot

Attribute #6004

This attribute initiates a device reboot.

Type	X
Size (Bytes)	N/A
User Mode Access	W
Values	N/A

Host Trigger Session

Attribute #6005

This attribute triggers a decode session similar to manually depressing the scanner trigger button.

Type	X
Size (Bytes)	N/A
User Mode Access	W
Values	1 = Start Host Trigger Session 0 = Stop Host Trigger Session

Firmware Version

Attribute #20004

The scanner's operating system version. For example, **NBRFMAAC** or **PAAAABS00-007-R03D0**.

Type	S
Size (Bytes)	Variable
User Mode Access	R
Values	Variable

Scankit Version

Attribute #20008

Identifies the 1D decode algorithms resident on the device, for example **SKIT4.33T02**.

Type	S
Size (Bytes)	Variable
User Mode Access	R
Values	Variable

ImageKit Version

Attribute #20013

Identifies the 2D decode algorithms resident on the device, for example **IMGKIT_7.01T08.31**

Type	S
Size (Bytes)	Variable
User Mode Access	R
Values	Variable

Index

Numerics

123Scan	24
requirements	25
2D bar codes	
aztec	230
aztec inverse	230
code 128 emulation	225
data matrix	226
data matrix inverse	227
han xin	231
han xin inverse	231
maxicode	227
microPDF417	224
microQR	229
PDF417	224
QR code	228
2D barcodes	
dotcode erasure limit	236

A

AAMVA field parsing	297
accessories	29, 43
adding window	30
ADF	254
advanced data formatting	254
aiming	44
control	45
aiming options	
snapshot aiming pattern	97
snapshot mode timeout	96
video view finder	111
aiming pattern	97
anti-reflection coatings	31, 32
attributes	
non-parameter	431
attributes, non-parameter	
configuration filename	432
date of first programming	432
date of manufacture	431
firmware version	434

host trigger session	434
model number	431
parameter defaults	434
reboot	434
scankit version	435
serial number	431
autoexposure	92

B

bar code defaults	
USB	114
bar codes	
Australia post	240
Australia post format	241
autoexposure	92
aztec	230
aztec inverse	230
beep after good decode	61
beeper duration	65
beeper tone	64
beeper volume	63
bits per pixel	106, 109
bookland EAN	159
bookland ISBN	171
cancel	413
Chinese 2 of 5	208
codabar	199
codabar CLSI editing	201
codabar lengths	200
codabar NOTIS editing	201
codabar start and stop characters	202, 203, 204
code 11	189
code 11 check digit verification	191
code 11 lengths	190
code 128	174
code 128 emulation	225
code 128 lengths	175
code 128 reduced quiet zone	180
code 128 security level	179
code 32 prefix	182
code 39	181

code 39 check digit verification	184
code 39 full ASCII	185
code 39 lengths	183
code 39 reduced quiet zone	187
code 39 security level	186
code 39 transmit check digit	184
code 93	187
code 93 lengths	188
composite beep mode	223
composite CC-A/B	220
composite CC-C	220
composite TLC-39	221
convert code 39 to code 32	182
convert GS1 databar to UPC/EAN	215
convert UPC-E to UPC-A	170
convert UPC-E1 to UPC-A	170
country code page defaults	362
country code pages	366
country codes	347
crop to address	99
data matrix	226
data matrix inverse	227
decode session timeout	69
digimarc	251
digimarc digital watermarks	251
disable all code types	156
discrete 2 of 5	197
discrete 2 of 5 lengths	198
driver's license parsing	293
AAMVA field parsing	297
driver's license date format	308
driver's license gender format	307
no separator	309
parser version ID	306
parsing field	295
send control characters	310
send keyboard characters	314
set defaults	307
EAN zero extend	171
EAN-13/JAN-13	159
EAN-8/JAN-8	158
enable all code types	156
enter	79
event reporting	
boot up event	148
decode event	147
parameter event	148
fixed exposure	94
flush macro buffer/abort macro PDF entry	249
FN1 substitution values	83
gain and exposure priority for snapshot mode	95
GS1 databar bar codes	214
GS1 databar expanded	215
GS1 databar limited	214
GS1 databar limited security level	216, 217
GS1 databar-14	214
GS1-128	176
GS1-128 emulation mode	223
han xin	231
han xin inverse	231
I 2 of 5 check digit verification	194
I 2 of 5 convert to EAN-13	195
I 2 of 5 reduced quiet zone	197
I 2 of 5 security level	196
I 2 of 5 transmit check digit	195
ignore code 128 fnc4	180
illumination	79, 92
image brightness (target white)	101
image cropping	98
image enhancement	103
image file format	104
image resolution	100
image rotation	105
intercharacter gap size	248
interleaved 2 of 5	192
convert to EAN-13	195, 196
interleaved 2 of 5 lengths	193
inverse 1D	213
ISBT 128	176
ISBT concatenation	177, 178
ISBT concatenation redundancy	178
ISSN EAN	173
Japan postal	239
JPEG image options	101
JPEG quality and size	102
JPEG target file size	102
Korean 3 of 5	212
lock/unlock parameter scanning	62
matrix 2 of 5	209
matrix 2 of 5 check digit	211
matrix 2 of 5 lengths	210
maxicode	227
microPDF417	224
microQR	229
mirrored image	78
mobile phone/display mode	72
MSI	205
MSI check digit algorithm	208
MSI check digits	207
MSI lengths	206
MSI transmit check digit	207
Netherlands KIX code	242
numeric bar codes	413
OCR	
check digit	283
check digit multiplier	284
check digit validation	285
default table	259
inverse OCR	290
lines	270

- maximum characters 271
- MICR E13B 267
- minimum character 270
- OCR-A 261
- OCR-A variant 261
- OCR-B 263
- OCR-B variant 264
- orientation 268
- parameters 261
- quiet zone 272
- redundancy 291
- subset 271
- template 273
- US currency serial number 268
- operational mode 90
- parameter scanning 60
- PDF prioritization 73
- PDF prioritization timeout 75
- PDF417 224
- picklist mode 68
- postal 234
- prefix/suffix values 81
- presentation mode field of view 76
- QR code 228
- quiet zone level 247
- redundancy level 244
- report version 248
- samples 391
- scan data options 82
- security level 246
- set defaults 59
- signature capture 107
- signature capture height 110
- signature capture JPEG quality 110
- silence operational mode changes 97
- snapshot aiming pattern 97
- snapshot mode 92
- snapshot mode timeout 96
- SSI
 - data packet format 142
 - host character timeout 144
 - host serial response time-out 143
 - interpacket delay 146
 - multipacket option 145
 - software handshaking 141
- suppress power up beeps 65
- symbologies
 - default table 150
- timeout between decodes, different symbols 71
- timeout between decodes, same symbol 71
- transmit code 11 check digits 192
- transmit code ID character 80
- transmit matrix 2 of 5 check digit 211
- transmit no read message 84
- transmit UK postal check digit 239
- transmit US postal check digit 238
- trigger mode 66
- trioptic code 39 181
- UCC coupon extended code 172
- UK postal 238
- unicode output control 376
- unsolicited heartbeat interval 85
- UPC composite mode 222
- UPC reduced quiet zone 165
- UPC/EAN
 - coupon code 172
- UPC/EAN supplemental AIM ID format 164
- UPC/EAN supplemental redundancy 163
- UPC/EAN supplementals 160
- UPC-A 157
- UPC-A check digit 165
- UPC-A preamble 167
- UPC-E 157
- UPC-E check digit 166
- UPC-E preamble 168
- UPC-E1 158
- UPC-E1 check digit 166
- UPC-E1 preamble 169
- UPU FICS postal 243
- US planet 237
- US postnet 237
- USB
 - caps lock override 119
 - convert case 124
 - country keyboard types (country codes) 347
 - device type 116
 - emulate keypad 121
 - emulate keypad with leading zero 121
 - fast HID 131
 - function key mapping 123
 - IBM specification version 131
 - keyboard FN 1 sub 122
 - keystroke delay 118
 - optional parameters 128
 - polling interval 129, 130
 - quick emulation 122
 - simulated caps lock 123
 - SNAPI handshaking 118
 - static CDC 125
 - unknown characters 120
- USPS 4CB/One Code/Intelligent Mail 242
- video image size 111
- video mode 92
- video view finder 111
- barcodes
 - dotcode erasure limit 236
 - illumination brightness 91
- block diagram 22
- component descriptions 22

C

Chinese 2 of 5 bar codes	208
CJK	375
coatings	31, 32
codabar bar codes	199
CLSI editing	201
lengths	200
NOTIS editing	201
start and stop characters	202, 203, 204
code 11 bar codes	189
check digit verification	191
lengths	190
transmit check digit	192
code 128 bar codes	174
GS1-128	176
ignore fnc4	180
ISBT 128	176
ISBT concatenation	177, 178
ISBT concatenation redundancy	178
lengths	175
reduced quiet zone	180
security level	179
code 128 emulation bar codes	225
code 39 bar codes	181
check digit verification	184
code 32 prefix	182
code 39	181
code 39 security Level	186
convert code 39 to code 32	182
full ASCII	185
lengths	183
reduced quiet zone	187
transmit check digit	184
trioptic	181
code 93 bar codes	187
lengths	188
code ID character	80
code identifiers	
AIM code IDs	386
modifier characters	387
Symbol	384
communication protocol	426
composite bar codes	
beep mode	223
composite CC-A/B	220
composite CC-C	220
composite TLC-39	221
GS1-128 emulation mode	223
UPC composite mode	222
country code page defaults	362
country code pages	366
country codes	347
cropping	98, 99

D

data matrix bar codes	226
data parsing	257
decode distances	
DL focus	52
SR focus	52
decode mode	90
decode zones	52, 259
DL focus	52, 53
SR focus	52, 53
default parameters	
DL parsing	292, 344
OCR	259
setting	59
SSI	140
symbolologies	150
USB	114
digimarc	250
digital watermarks bar codes	251
digimarc digital watermarks	251
discrete 2 of 5 bar codes	197
lengths	198
DL focus decode distances	52
driver's license parsing	
AAMVA field parsing	297
ADF example	332
bar codes	293
control characters	310
data fields	294
date format	308
default parameters	292
field parsing bar codes	295
gender format	307
keyboard characters	314
no separator	309
parser version ID	306
rule example	328

E

electrical interface	47
engine	22
theory of operation	22
error indications	
unknown characters	120
exit window	
coatings	31
diagram	34, 35
material	31
properties	31, 36
exposure options	
autoexposure	92
fixed exposure	94
gain and exposure priority for snapshot mode	95

- illumination 79, 92
 - presentation mode field of view 76
- F**
- fixed exposure 94
- G**
- gain and exposure priority for snapshot mode 95
 - GS1 databar 214
 - GS1 databar bar codes
 - convert GS1 databar to UPC/EAN 215
 - GS1 databar expanded 215
 - GS1 databar limited 214
 - GS1 databar limited security level 216, 217
 - GS1 databar-14 214
- H**
- host types
 - USB 116
- I**
- illumination 79, 92
 - brightness 91
 - control 46
 - illumination system 45
 - image brightness (target white) 101
 - image cropping 98, 99
 - image enhancement 103
 - image options
 - bits per pixel 106
 - cropping 98, 99
 - file formats 104
 - image brightness (target white) 101
 - image enhancement 103
 - image resolution 100
 - image rotation 105
 - JPEG image options 101
 - JPEG size/quality 102
 - JPEG target file size 102
 - image resolution 100
 - imager overview 21, 24, 254
 - imaging engine 22
 - installation
 - connecting 29
 - location 30
 - mounting 27
 - interleaved 2 of 5 bar codes 192
 - check digit verification 194
 - convert to EAN-13 195
 - lengths 193
 - reduced quiet zone 197
 - security level 196
 - transmit check digit 195
- J**
- JPEG image options 101
 - size/quality 102
 - JPEG target file size 102
- K**
- keyboard types (country codes)
 - Albanian 347
 - Arabic (101) 347
 - Arabic (102) 347
 - Arabic (102) Azerty 348
 - Azeri (Cyrillic) 348
 - Azeri (Latin) 348
 - Belarusian 348
 - Bosnian (Cyrillic) 348
 - Bosnian (Latin) 348
 - Bulgarian (Latin) 348
 - Bulgarian Cyrillic (Typewriter) 349
 - Canadian French (Legacy) 349
 - Canadian French Win7 349
 - Canadian Multilingual Standard 349
 - Chinese (ASCII) 349
 - Croatian 350
 - Czech 350
 - Czech (Programmer) 350
 - Czech (QWERTY) 350
 - Danish 350
 - Dutch (Netherlands) 350
 - Estonian 351
 - Faeroese 351
 - Finnish 351
 - French (Canada) 2000/XP 351
 - French (Canada) 95/98 351
 - French (France) 351
 - French International 351
 - Galician 352
 - German 352
 - Greek 352
 - Greek (220) Latin 352
 - Greek (319) Latin 352
 - Greek 220 352
 - Greek 319 353
 - Greek Latin 352
 - Greek Polytonic 353
 - Hebrew Israel 353
 - Hungarian 353
 - Hungarian_101KEY 353
 - Irish 353
 - Islandic 353
 - Italian 354

Italian (142)	354
Japanese (ASCII)	354
Kazakh	354
Korean (ASCII)	354
Kyrgyz	355
Latin American	355
Latvian	355
Latvian (QWERTY)	355
Lithuanian	355
Lithuanian (IBM)	355
Macedonian (FYROM)	355
Maltese_47KEY	356
Mongolian	356
Norwegian	356
Polish (214)	356
Polish (Programmer)	356
Portuguese (Brazil)	356
Portuguese (Brazilian ABNT)	356
Portuguese (Brazilian ABNT2)	357
Portuguese (Portugal)	357
Romanian	357
Romanian (Legacy)	357
Romanian (Programmer)	357
Romanian (Standard)	357
Russian	358
Russian (Typewriter)	358
Serbian (Cyrillic)	358
Serbian (Latin)	358
Slovak	358
Slovak (QWERTY)	358
Slovenian	358
Spanish	359
Spanish (Variation)	359
Swedish	359
Swiss French	359
Swiss German	359
Tatar	359
Thai (Kedmanee)	359
Turkish F	360
Turkish Q	360
UK English	360
Ukranian	360
US Dvorak	360
US Dvorak Left	360
US Dvorak Right	360
US English	347
US International	361
Uzbek	361
Vietnamese	361
Korean 3 of 5 bar codes	212

L

laser	44
LED	44, 45

M

macro PDF	249
flush buffer/abort PDF entry	249
maintenance	54
matrix 2 of 5 bar codes	209
check digit	211
lengths	210
transmit check digit	211
maxicode bar codes	227
MDF	254
microPDF417 bar codes	224
modes of operation	46
mounting	27
dimensions	27
MSI bar codes	205
check digit algorithm	208
check digits	207
lengths	206
transmit check digit	207
multicode data formatting	254

N

non-parameter attributes	431
configuration filename	432
date of first programming	432
date of manufacture	431
firmware version	434
host trigger session	434
model number	431
parameter defaults	434
reboot	434
scankit version	435
serial number	431

O

OCR

default parameters	259
parameters	261
operating modes	46
operational mode	90
decode mode	90
snapshot mode	90
video mode	92
optical	
exit window material	31
path and exit window diagram	34, 35
overview	
imager	21, 24, 254

P

parameter defaults	
--------------------	--

- USB 114
 - parameters
 - USB 116
 - PDF417 bar codes 224
 - PDF prioritization 73
 - polysiloxane coating 32
 - postal codes 234
 - Australia post 240
 - Australia post format 241
 - Japan postal 239
 - Netherlands KIX code 242
 - transmit UK postal check digit 239
 - transmit US postal check digit 238
 - UK postal 238
 - UPU FICS postal 243
 - US planet 237
 - US postnet 237
 - USPS 4CB/One Code/Intelligent Mail 242
 - preferred symbol 257
 - presentation mode field of view 76
 - processing/control board
 - theory of operation 22
- Q**
- QR code bar codes 228
- R**
- RSM
 - commands and responses over SSI 138
- S**
- sample bar codes 391
 - scanning
 - errors 57, 88, 120, 149
 - sequence example 57, 88, 149
 - SE4500 22
 - security
 - intercharacter gap size 248
 - quiet zone level 247
 - redundancy level 244
 - security level 246
 - setting defaults 59
 - setup
 - connecting a USB interface 113
 - signature capture 107
 - bits per pixel 109
 - height 110
 - JPEG quality 110
 - simple serial interface
 - commands 133
 - communications 132, 136
 - default parameters 140
 - handshaking 134, 136
 - RSM commands and responses 138
 - transactions 134
 - skew, pitch and roll 51
 - SNAPI
 - SDK 43
 - snapshot mode 90
 - snapshot mode timeout 96
 - software developer's kit
 - SNAPI 43
 - software tools
 - 123Scan 24
 - ADF 254
 - MDF 254
 - preferred symbol 257
 - SR focus decode distances 52
 - SSI
 - commands 133
 - communications 132, 136
 - default parameters 140
 - handshaking 134, 136
 - RSM commands and responses 138
 - transactions 134
 - symbology default parameters 150
- T**
- theory of operation
 - engine 22
 - processing/control board 22
 - trigger mode 66
- U**
- unicode
 - output control 376
 - UPC/EAN bar codes
 - bookland EAN 159
 - bookland ISBN 171
 - check digit 165, 166
 - convert UPC-E to UPC-A 170
 - convert UPC-E1 to UPC-A 170
 - EAN zero extend 171
 - EAN-13/JAN-13 159
 - EAN-8/JAN-8 158
 - ISSN EAN 173
 - reduced quiet zone 165
 - supplemental AIM ID format 164
 - supplemental redundancy 163
 - supplementals 160
 - UCC coupon extended code 172
 - UPC-A 157
 - UPC-A preamble 167
 - UPC-E 157
 - UPC-E preamble 168

UPC-E1 158
UPC-E1 preamble 169
USB connection 113
USB defaults 114
USB parameters 116

V

video mode 92
video view finder 111
 image size 111

W

window
 adding 30

